

**REFLECTOR HALOGENO
DETALLE SOPORTE DE TUBO**
ESCALA 1 : 10

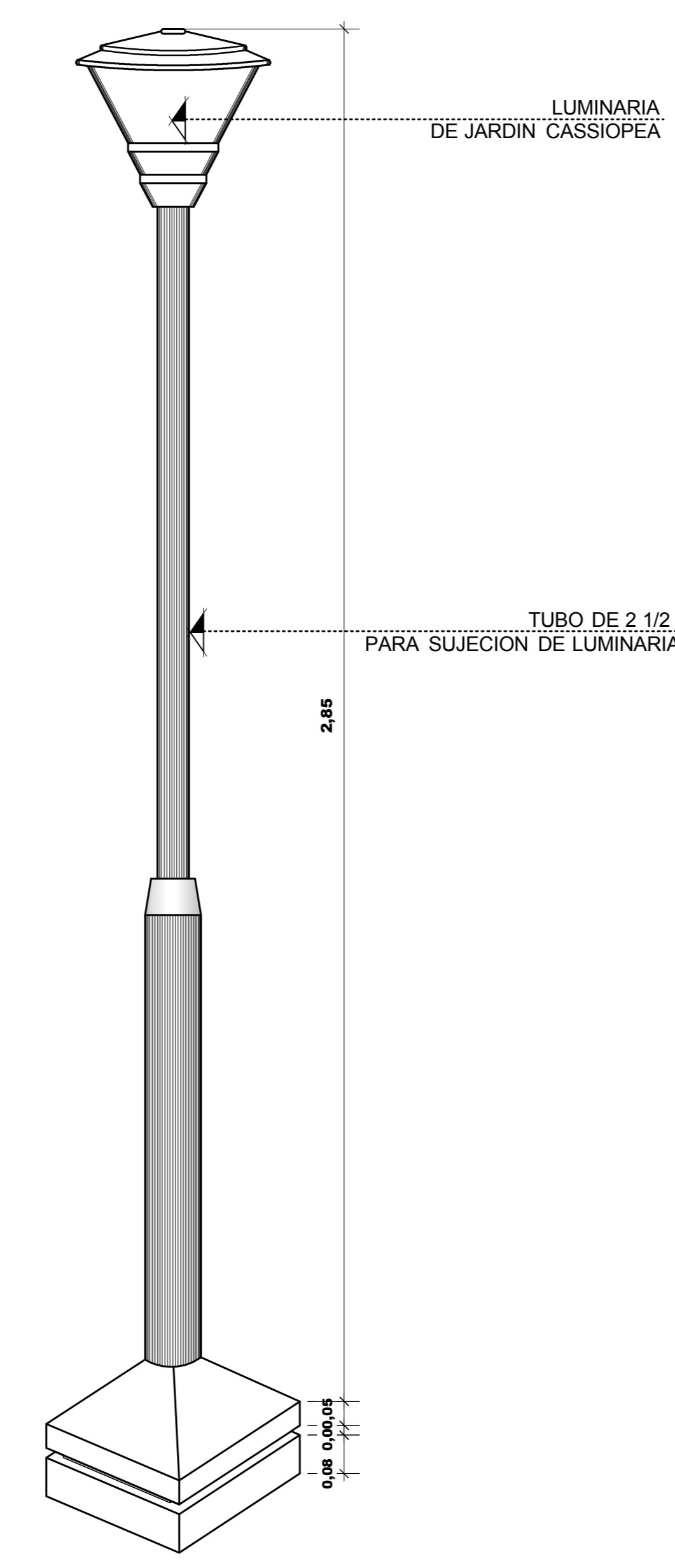

**ISOMETRIA
LUMINARIA EXTERIOR jardin**
ESCALA 1 : 10

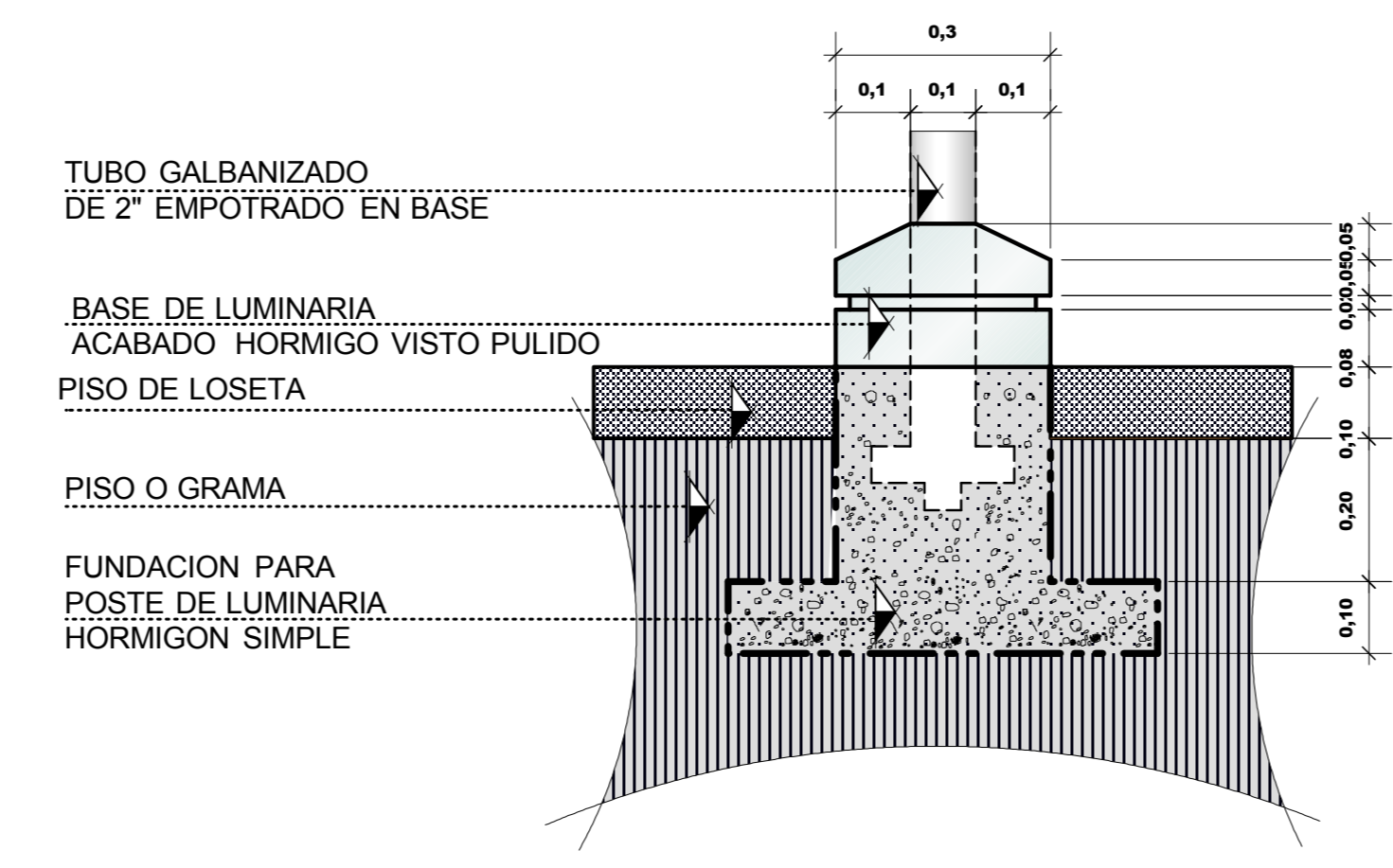

**DETALLE FUNDACION
LUMINARIA EXTERIOR JARDIN**
ESCALA 1 : 10

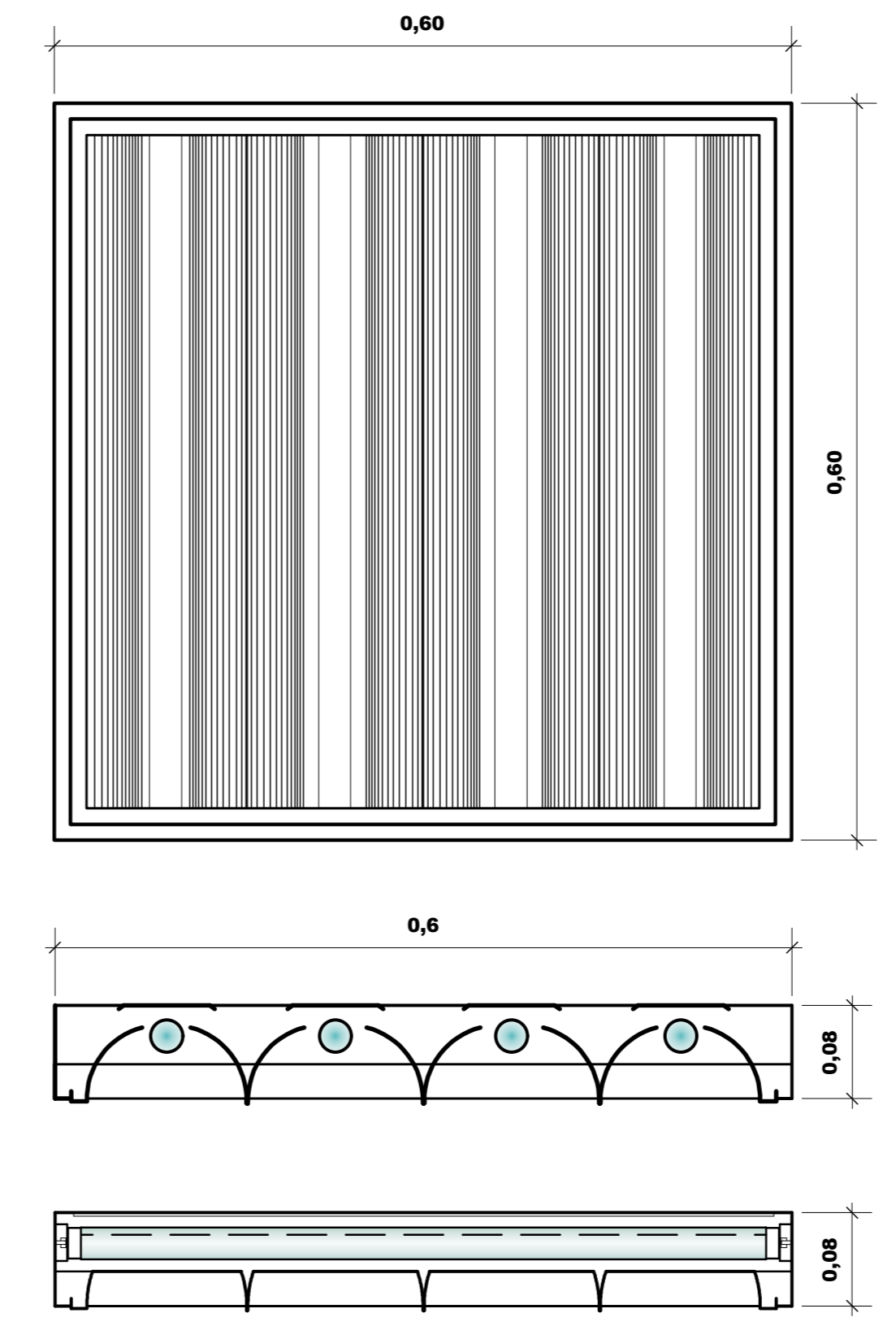

**ILUMINACION FLUORESCENTE
MODELOEAE 420 MARCA FyK**
ESCALA 1 : 5

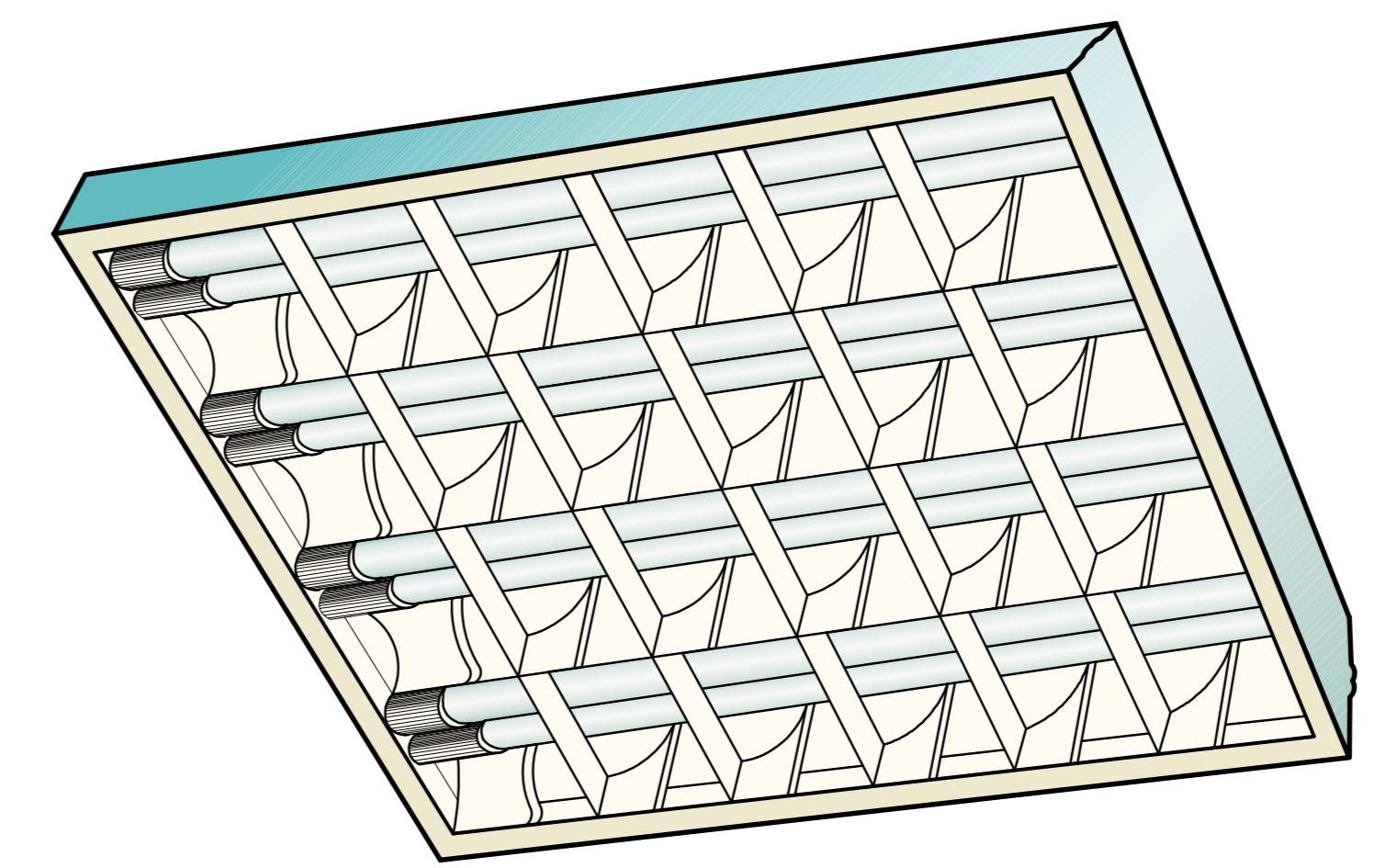

**ISOMETRIA ILUMUNACION
FLUORESCENTE MODELO
EAE 420 MARCA FyK**
ESCALA 1 : 5

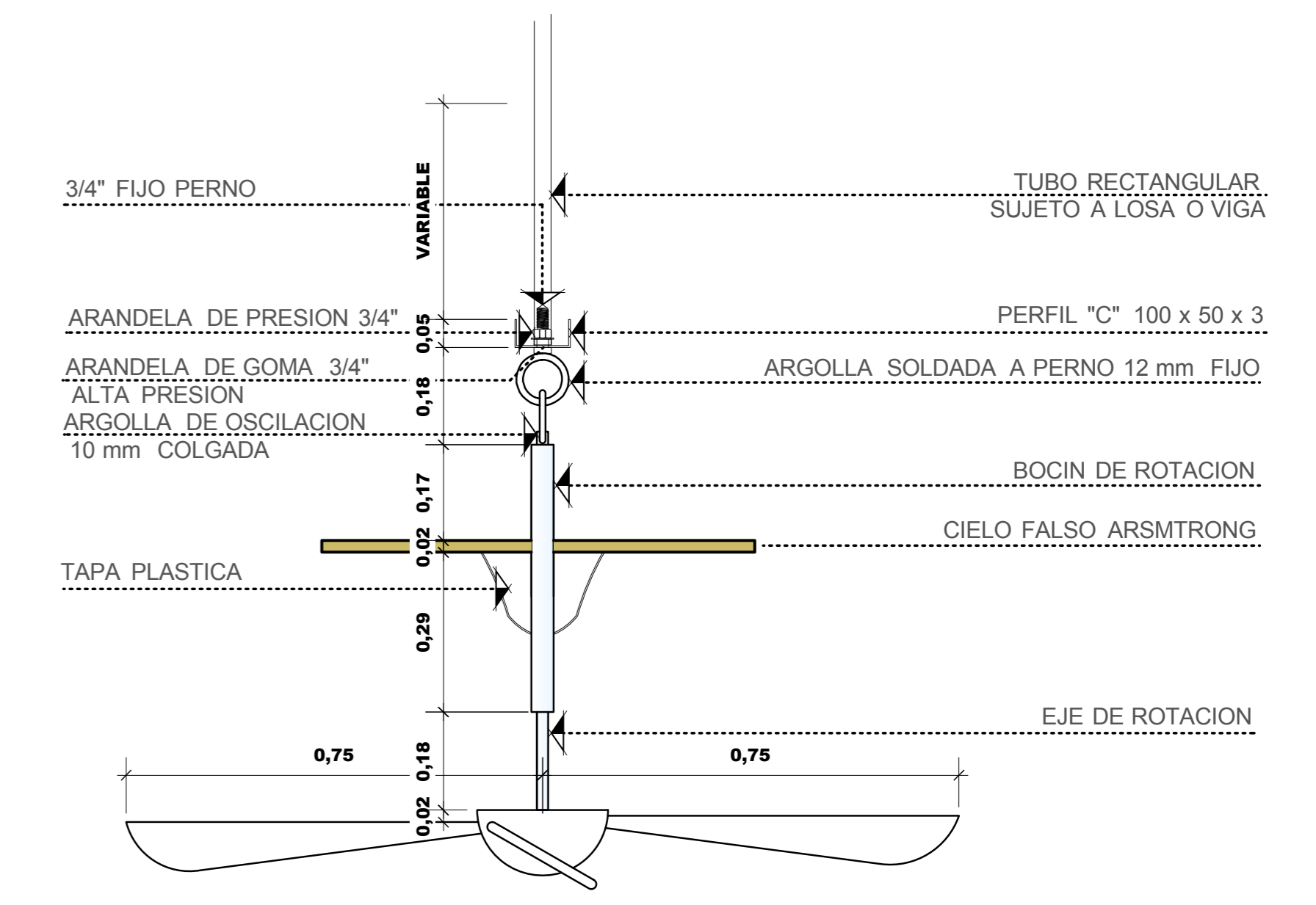
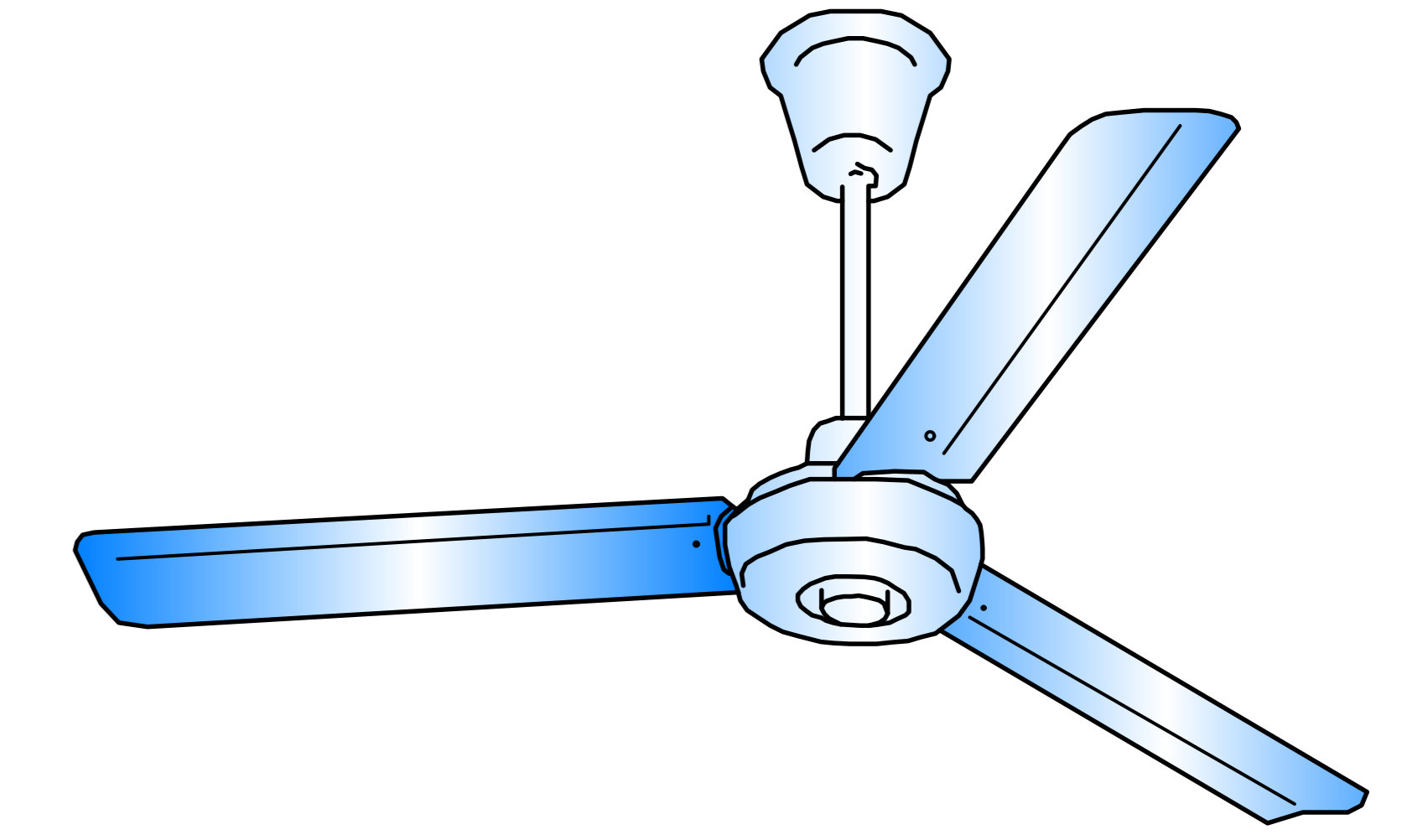

**VENTILADOR DE TECHO
PANASONIC F - 5609H**
ESCALA 1 : 10

~~DETALLES CONSTRUCTIVOS~~

SISTEMA CONTRA INCENDIOS

MARCO Y PUERTA DE ACERO INOXIDABLE Y VIDRIO

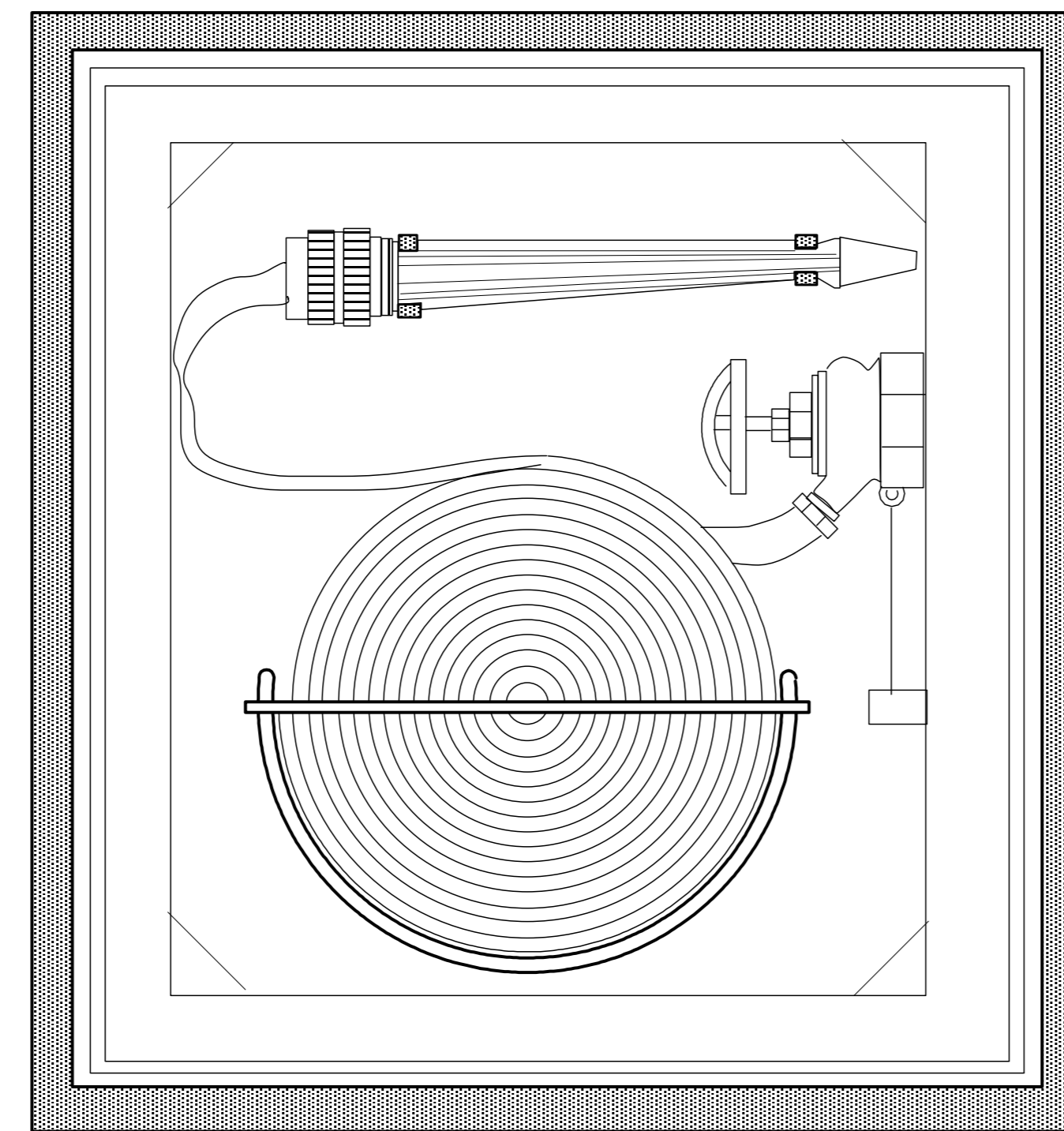

CAPACIDAD MINIMA DEL TANQUE UNIFICADO O MIXTO

$$V = V1 + 0.5 * V2$$

DONDE
 V= CAPACIDAD MINIMA DEL TANQUE M3
 V1= CAPACIDAD MINIMA REQUERIDA PARA EL DESTINO MAS EXIGENTE M3
 V2=CAPACIDAD CORRESPONDIENTE AL DESTINO MENOS EXIGENTE M3

SISTEMA CONTRA INCENDIOS AUTOMATICO CON DETECTOR DE HUMO DE HUMO

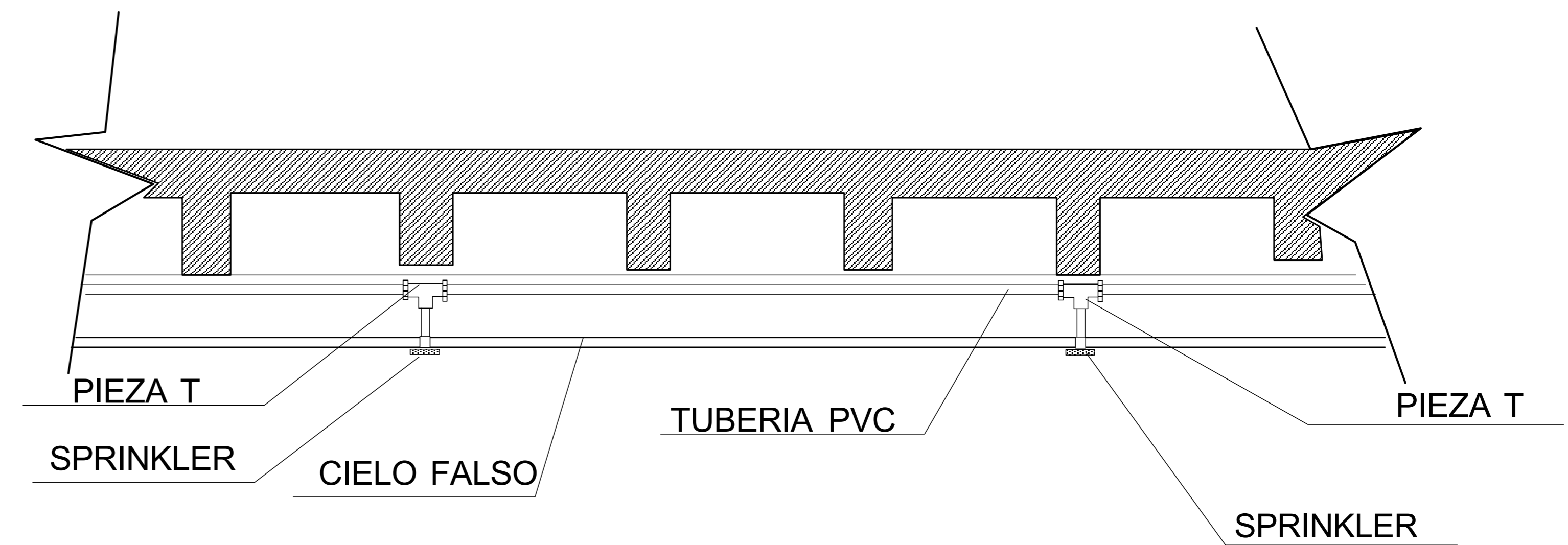

DETALLE DE SPRINKLER

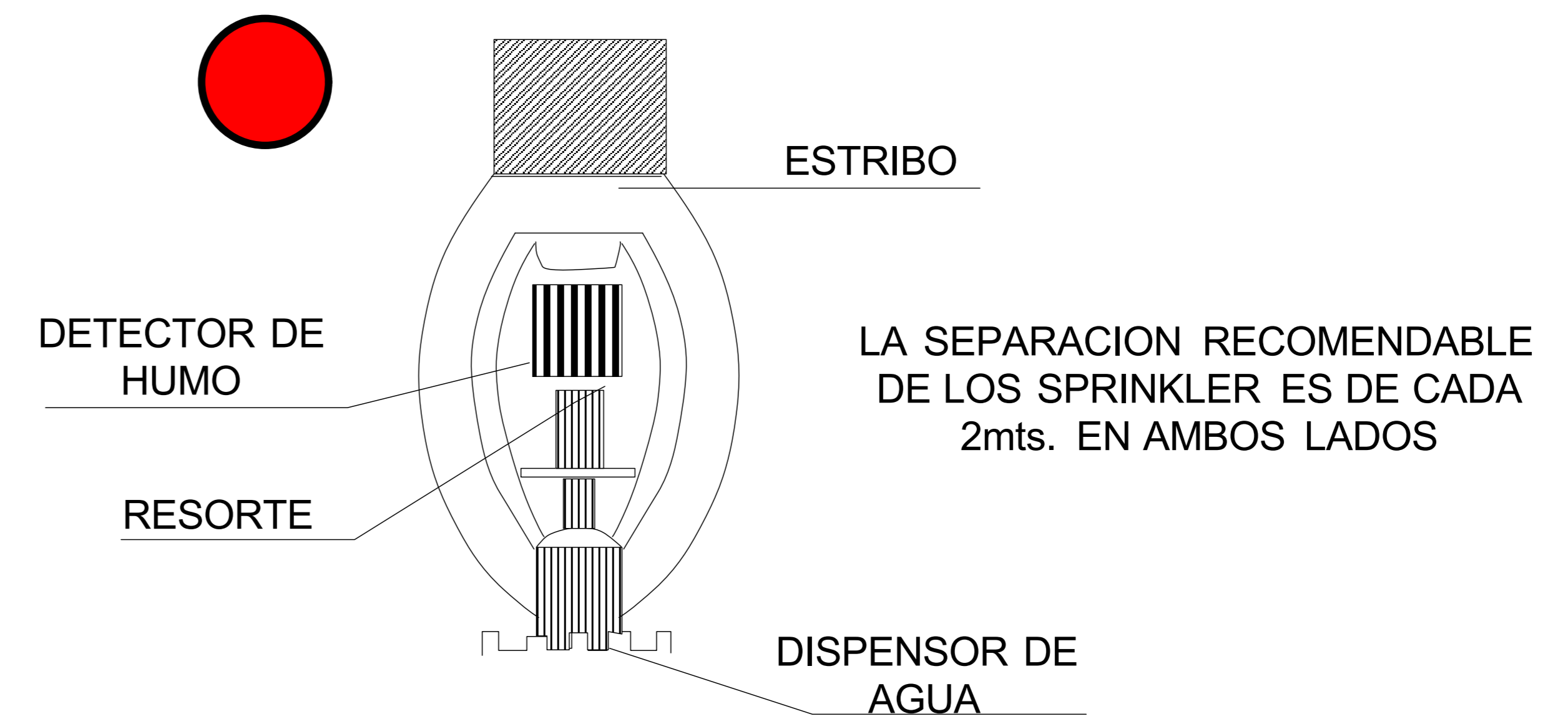

~~DETALLES CONSTRUCTIVOS~~



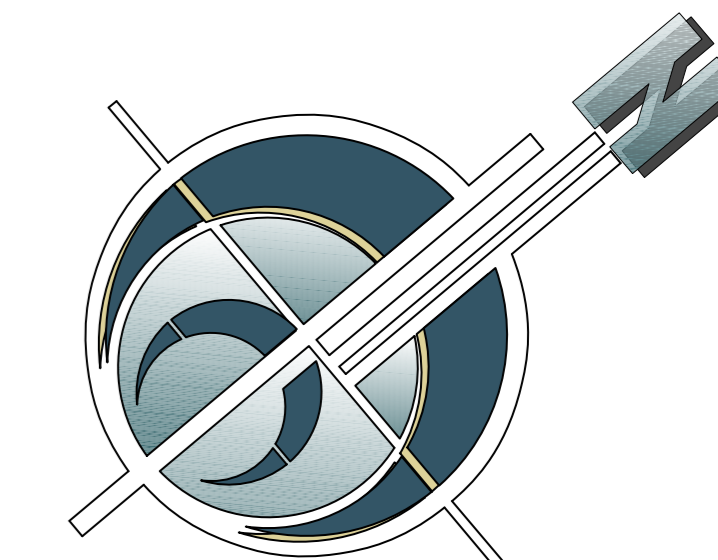
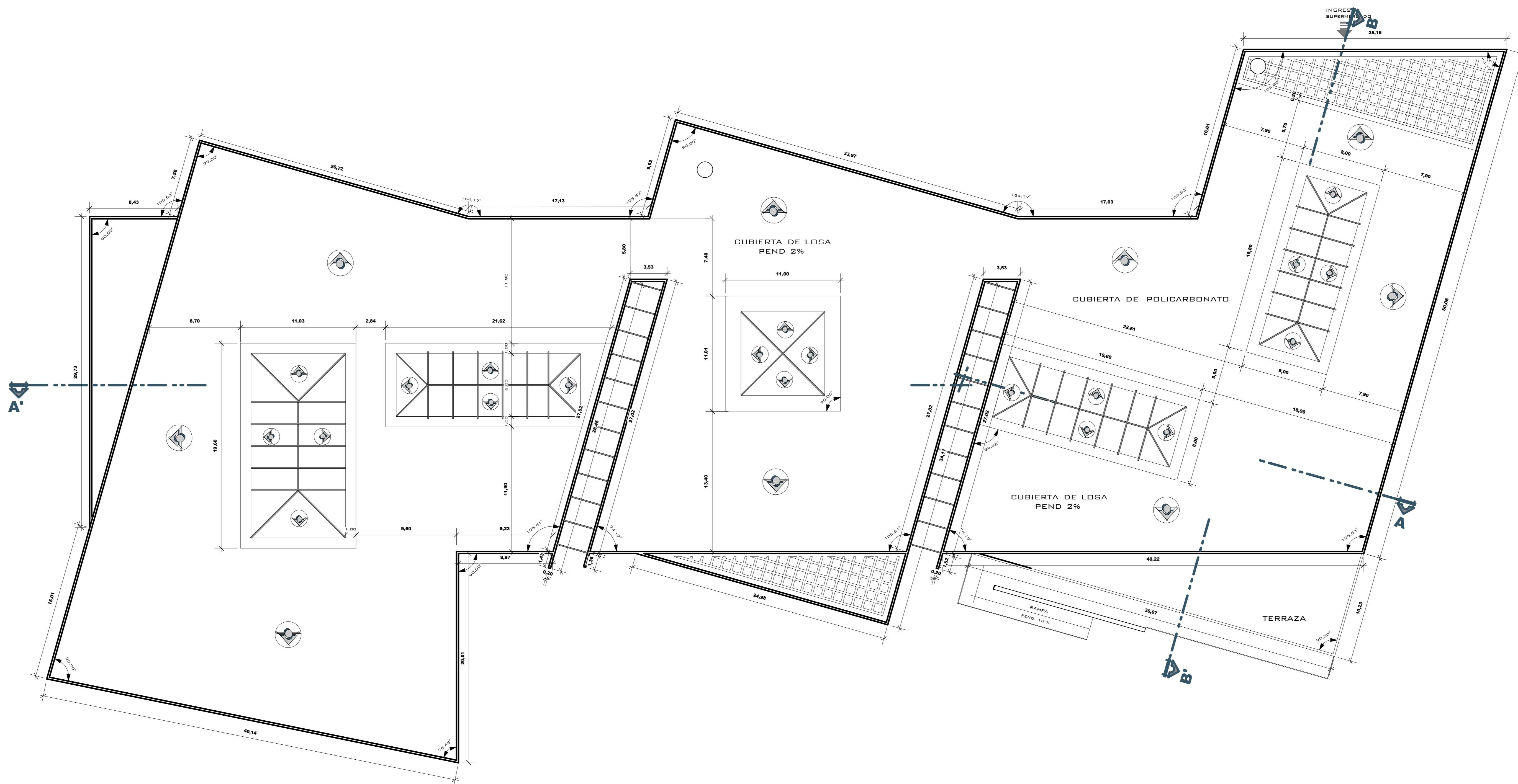

PLANTA TECHO

ESC. 1 : 200

 UNIVERSIDAD AUTONOMA JUAN MISAEL SARACHO CARRERA DE ARQUITECTURA Y URBANISMO	PROYECTO: CENTRO COMERCIAL	PLANO: ACOTADO SITIO Y TECHOS	DOCENTE: ARQ. MECHTHILD KAISER	LAMINA 22
		ESCALA : 1 : 200	ALUMNO: JHONNY MARTINEZ MANCILLA	

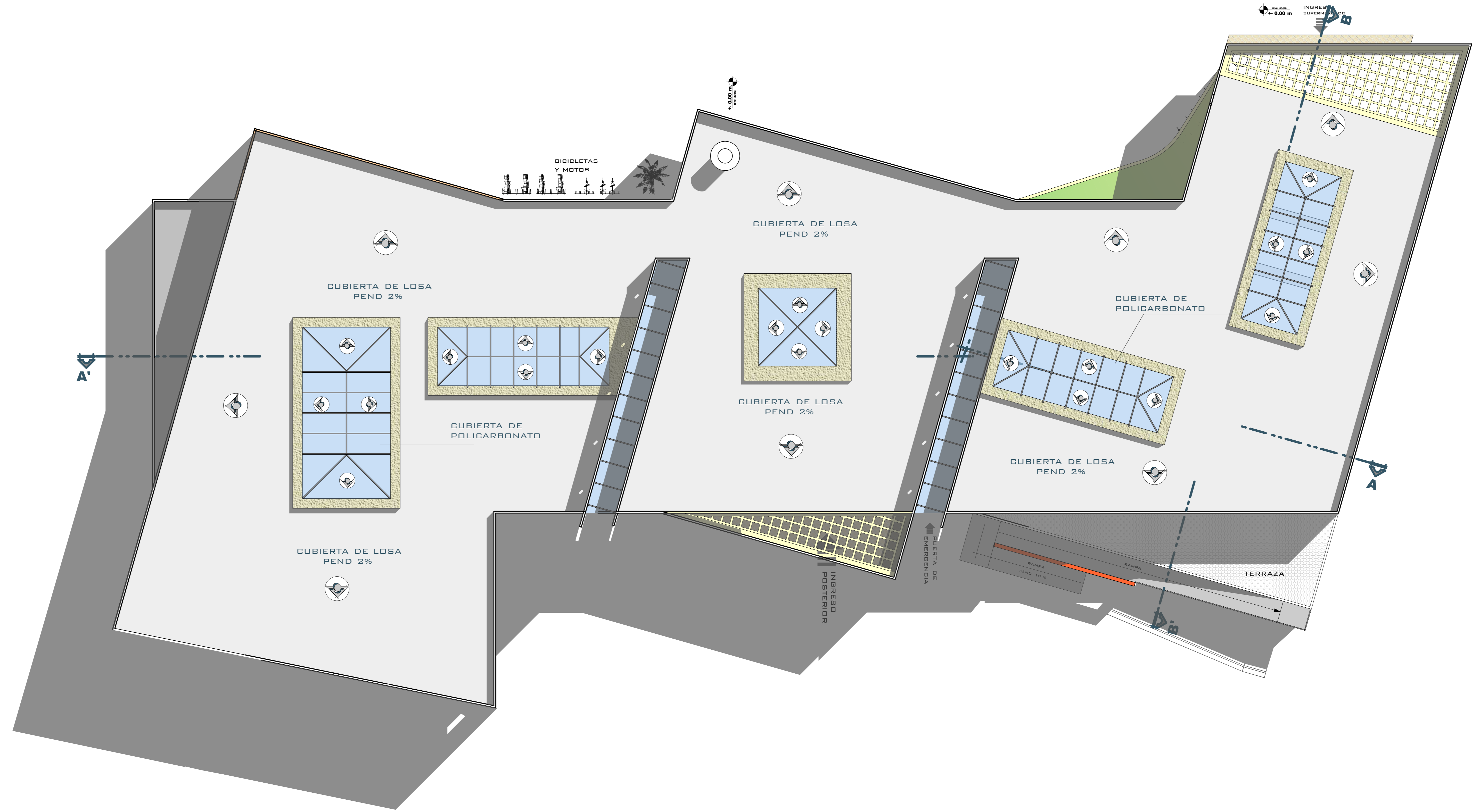
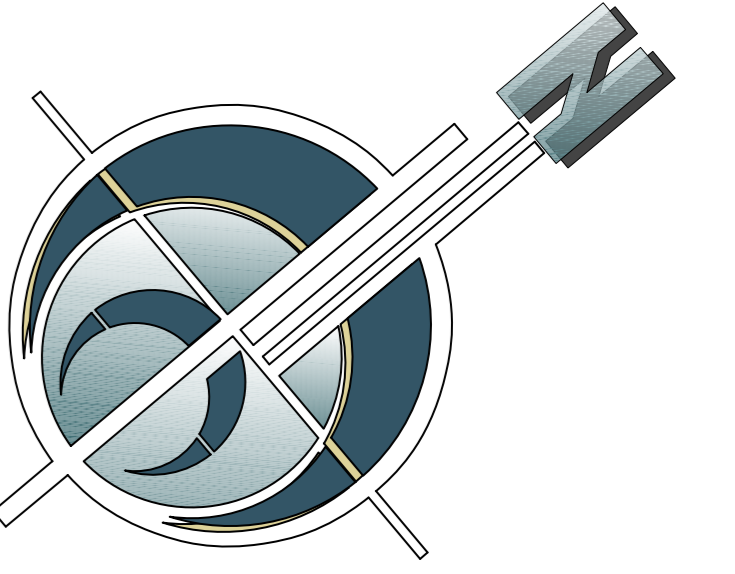

PLANTA TECHO

ESC. 1 : 200

 UNIVERSIDAD AUTONOMA JUAN MISAEL SARACHO CARRERA DE ARQUITECTURA Y URBANISMO	PROYECTO:	PLANO: AMOBLADO	DOCENTE:	LAMINA 23
	CENTRO COMERCIAL	SITIO Y TECHO	ARQ. MECHTHILD KAISER	
		ESCALA : 1 : 200	ALUMNO: JHONNY MARTINEZ MANCILLA	

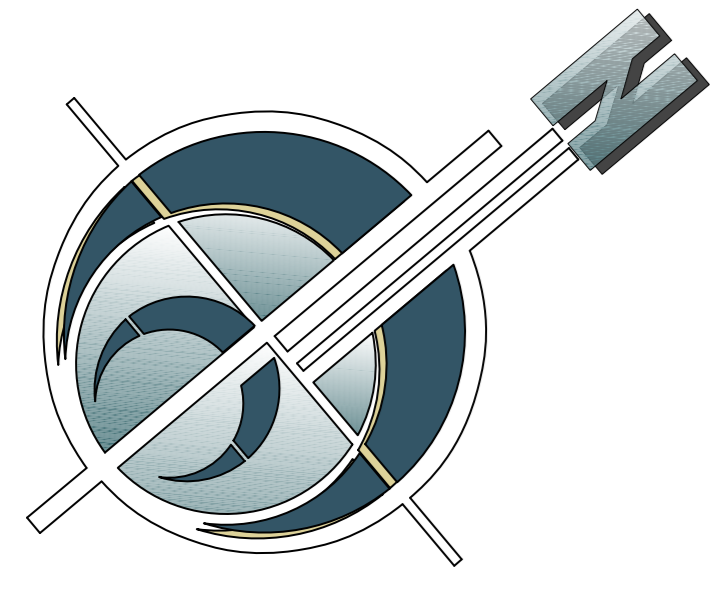

EZQUEMA PAISAJISTICO	
CUADRO DE REFERENCIA	
CARNIVALITO	
SEBO	
JACOBINA	
PALESA	
SAUCE	
MOLLE	
ALISO	

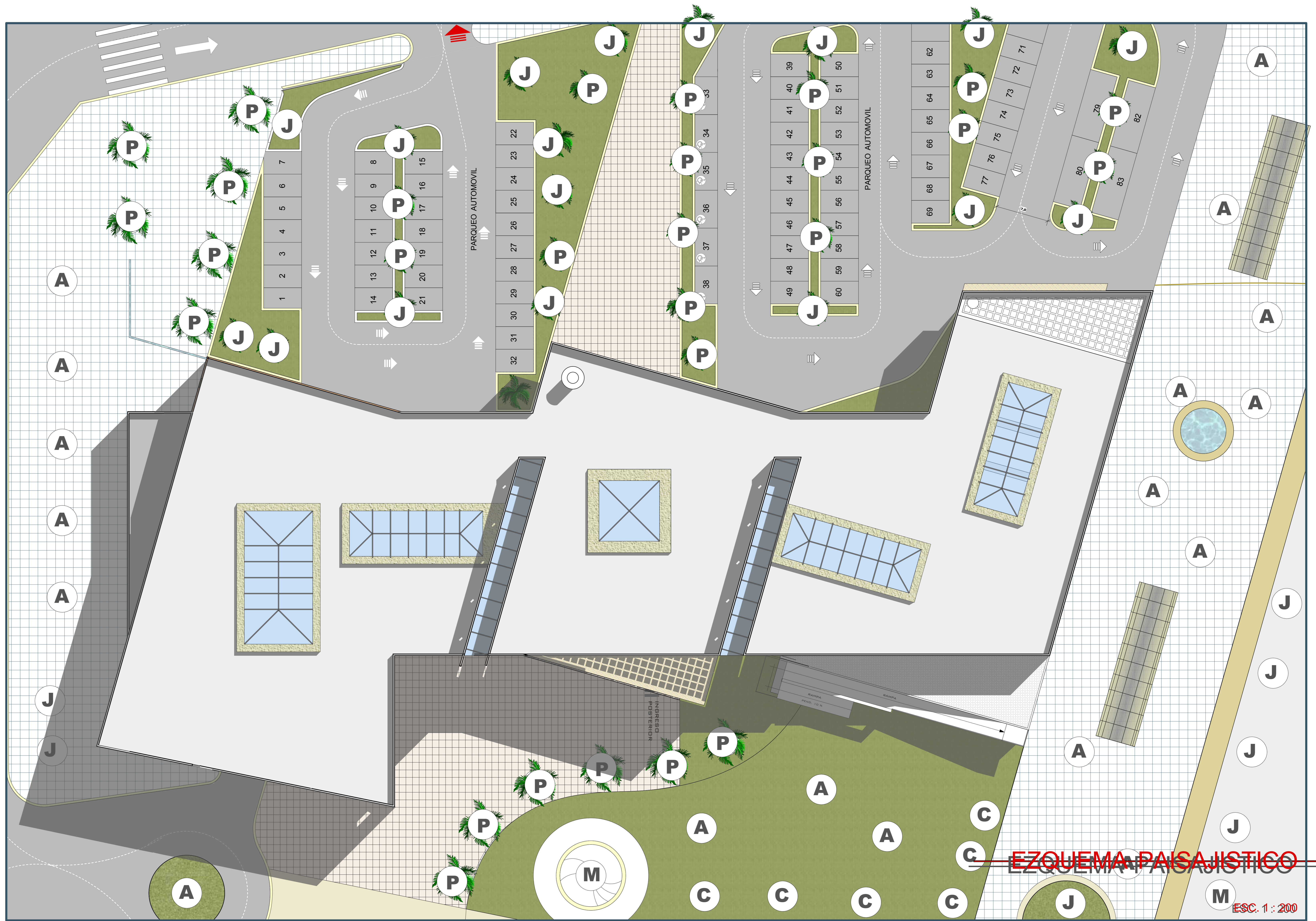

EZQUEMA PAISAJISTICO

ESC. 1 : 200



~~PERSPECTIVA EXTERIOR~~
PERSPECTIVA EXTERIOR

	<p>UNIVERSIDAD AUTONOMA JUAN MISAEL SARACHO CARRERA DE ARQUITECTURA Y URBANISMO</p>	<p>PROYECTO: CENTRO COMERCIAL</p>	<p>PLANO: PERSPECTIVAS ESCALA :</p>	<p>DOCENTE: ARQ. MECHTHILD KAISER ALUMNO: JHONNY MARTINEZ MANCILLA</p>	<p>LAMINA 25</p>
---	---	--	---	--	-----------------------------



PERSPECTIVA INTERIOR



UNIVERSIDAD AUTONOMA JUAN MISAEL SARACHO
CARRERA DE ARQUITECTURA Y URBANISMO

PROYECTO:

CENTRO COMERCIAL

PLANO: PERSPECTIVAS

ESCALA :

DOCENTE:
ARQ. MECHTHILD KAISER

ALUMNO:
JHONNY MARTINEZ MANCILLA

LAMINA
26