

UNIVERSIDAD AUTONOMA JUAN MISAEL SARACHO

FACULTAD DE CIENCIAS Y TECNOLOGÍA

CARRERA: INGENIERÍA CIVIL

PROYECTO:
DISEÑO DE INGENIERÍA DEL TRAMO CRUCE LOS NARANJOS - CRUCE SERERE LIMAL

CARACTER:
PLANO DE SECCIONES TRANSVERSALES

MATERIA:
CIV - 502 PROYECTO DE INGENIERIA CIVIL II

ESTUDIANTE:
MARIO ALBERTO MARTINEZ SALINAS

FECHA:
17 DE SEPTIEMBRE DE 2019

ESCALA:
1:300

Nº DE PLANO

1/10

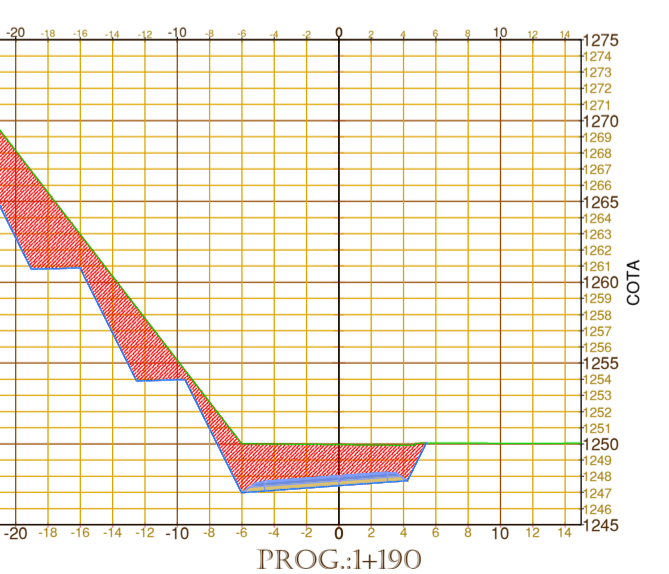
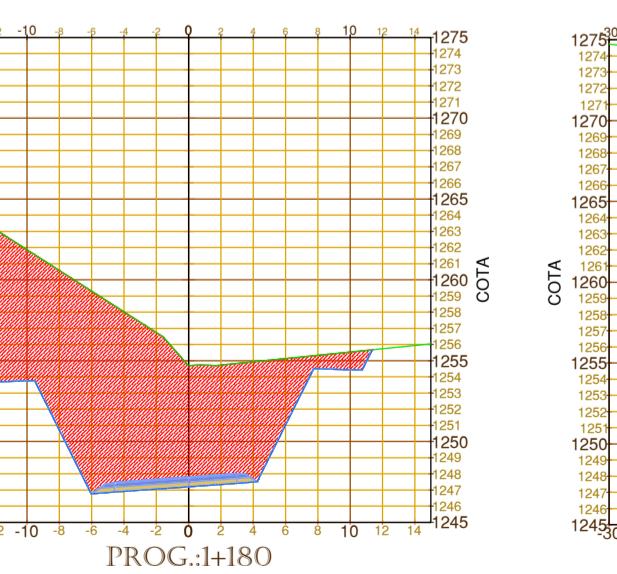
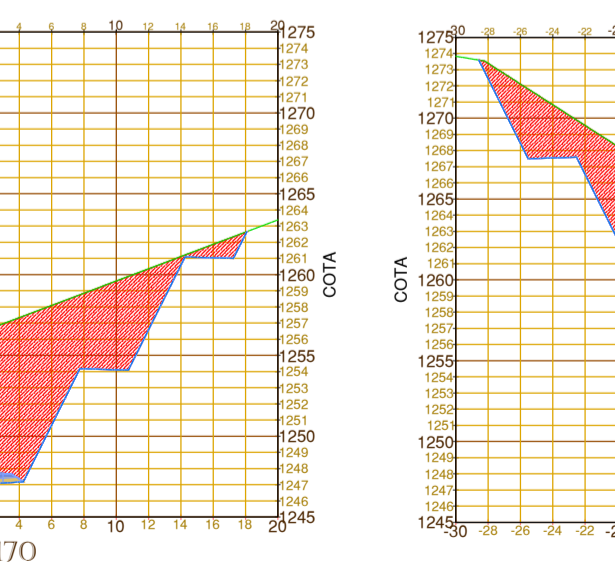
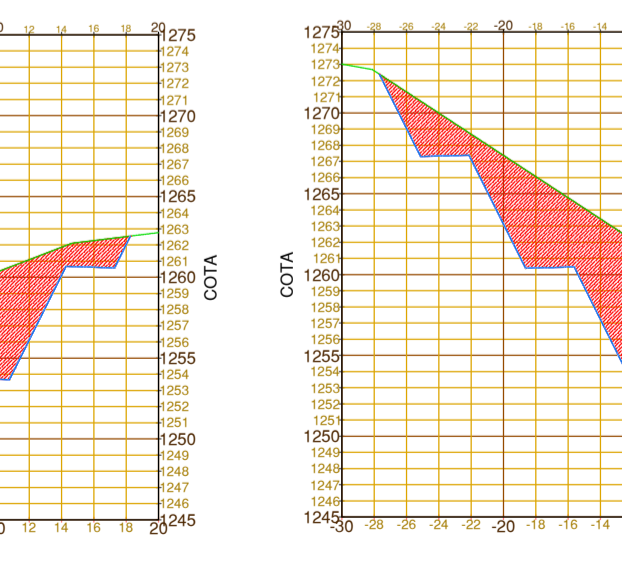
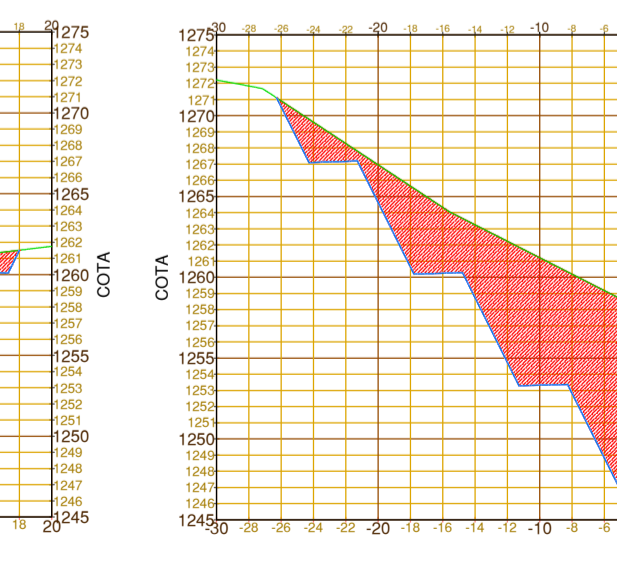
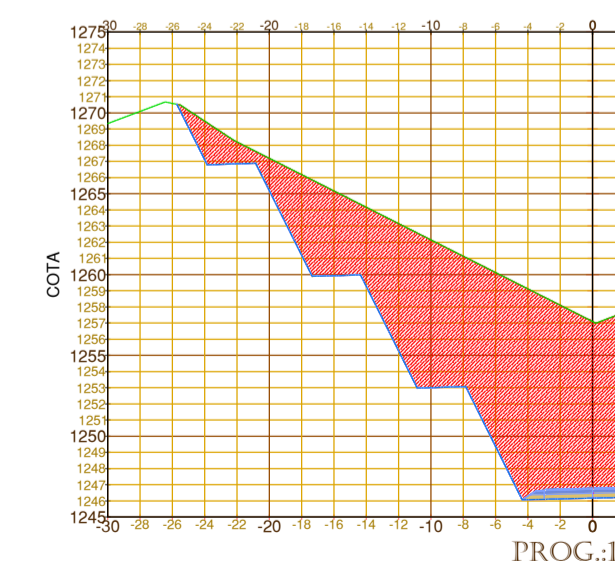
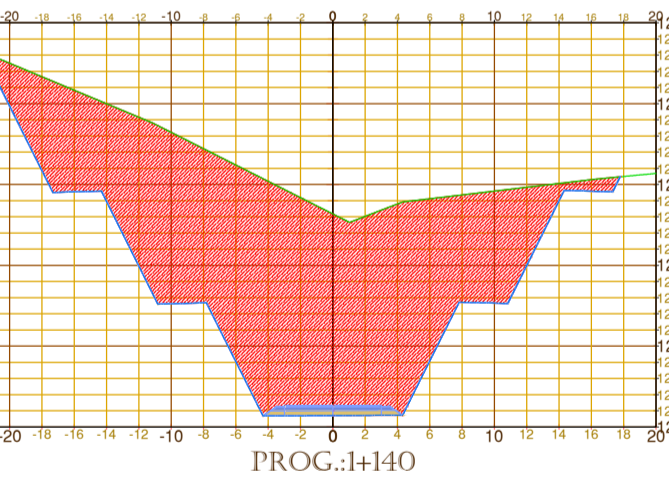
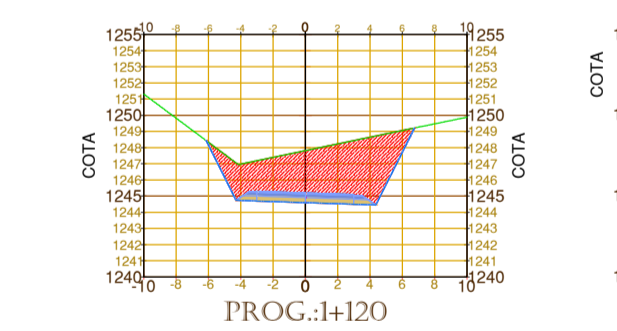
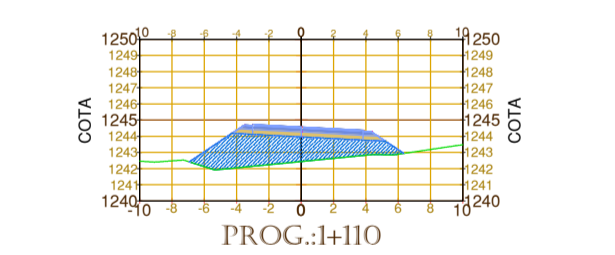
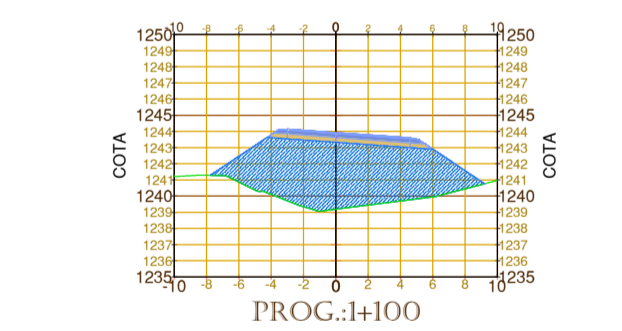
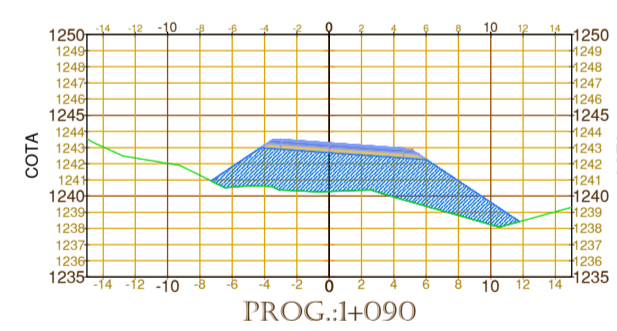
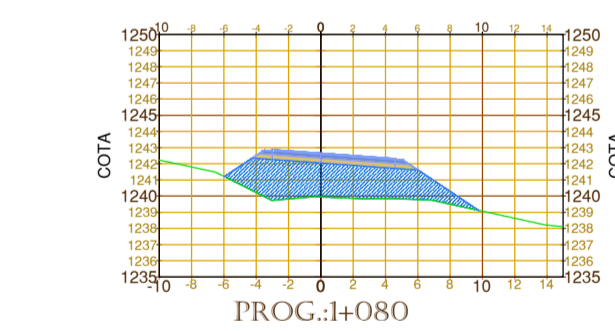
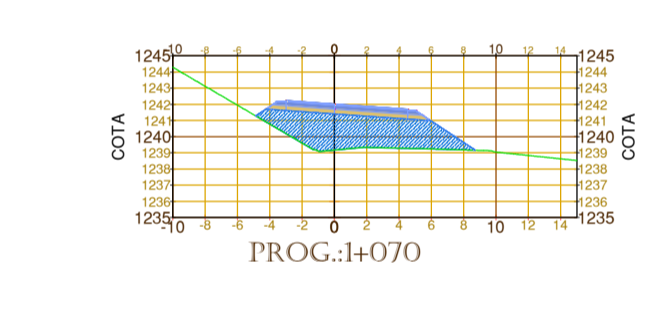
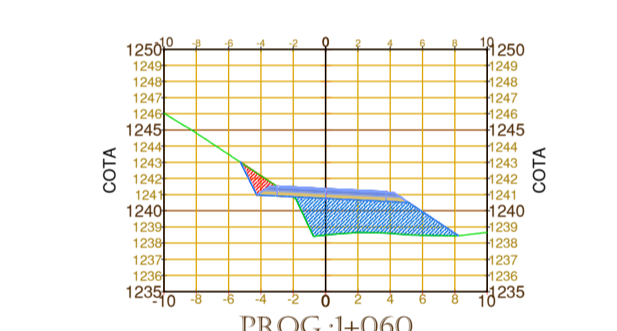
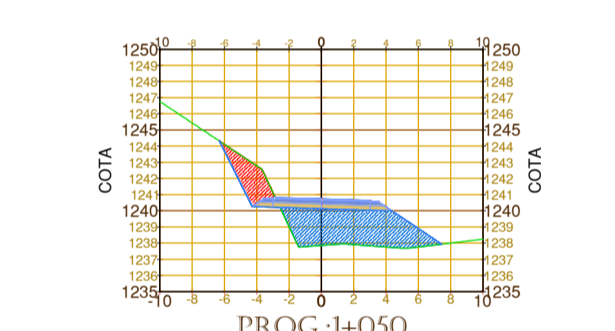
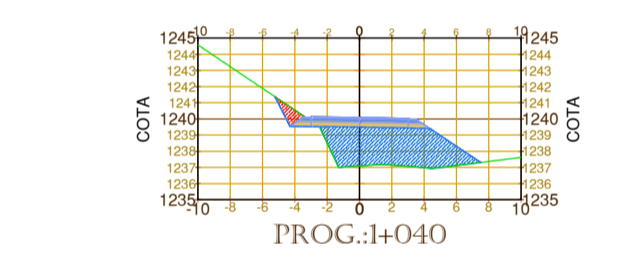
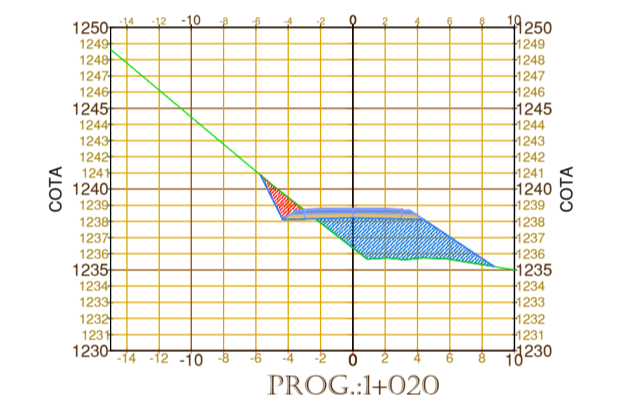
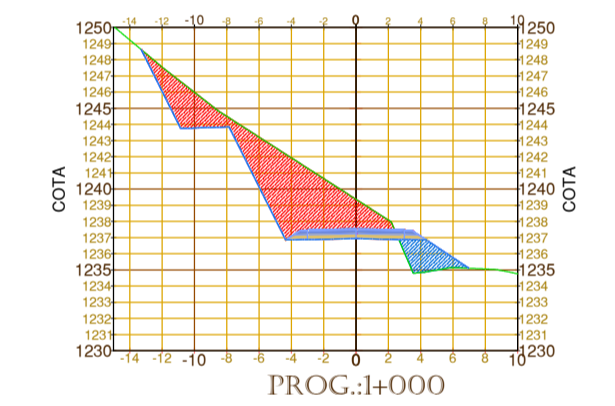
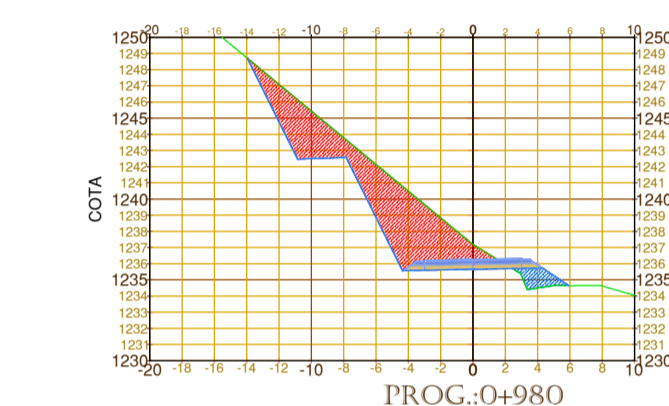
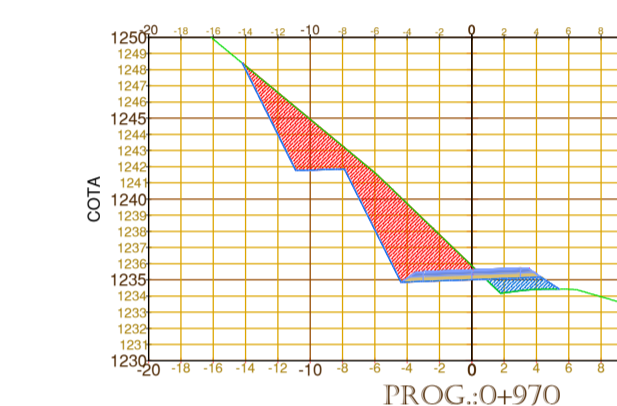
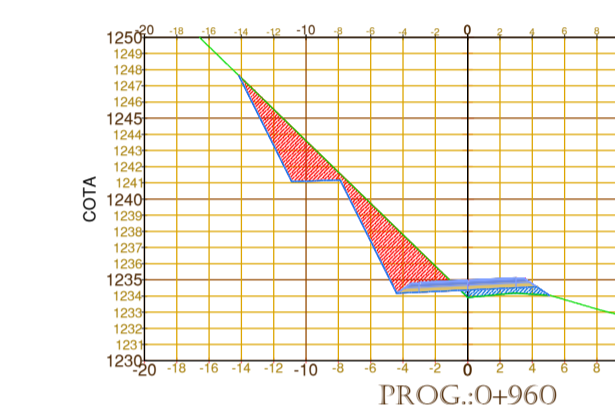
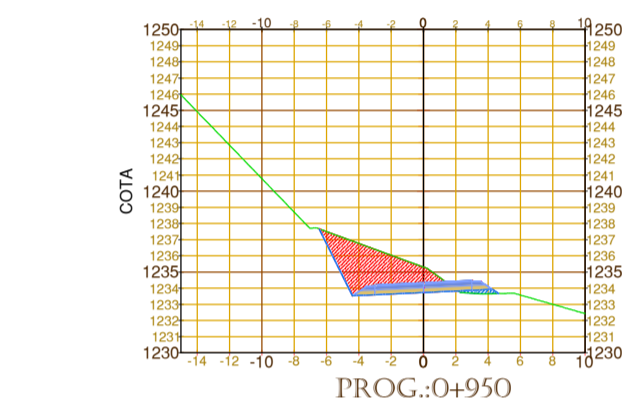
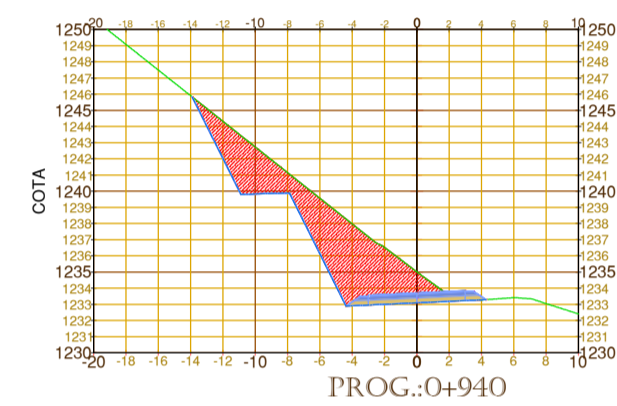
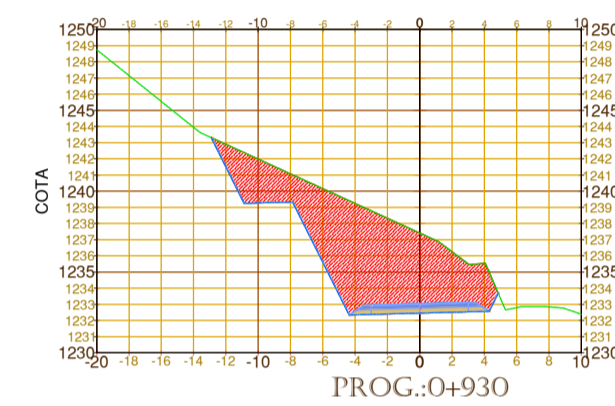
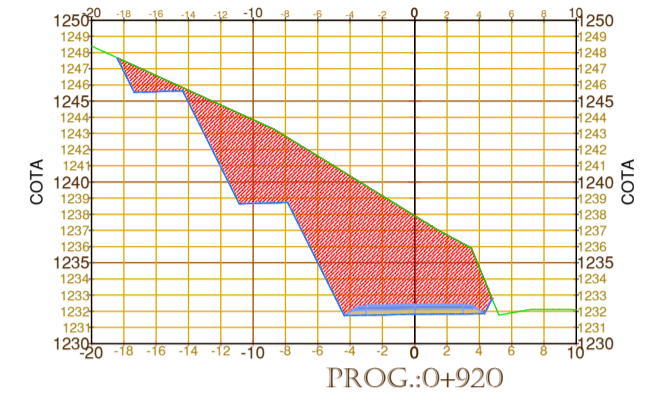
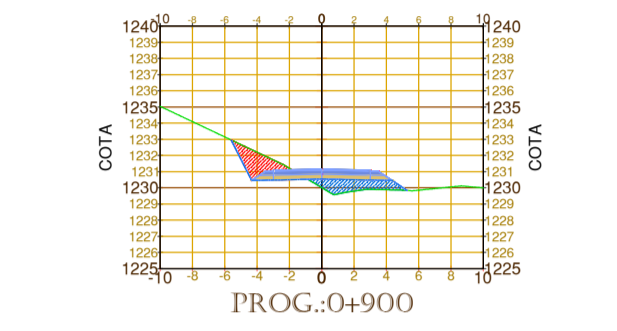
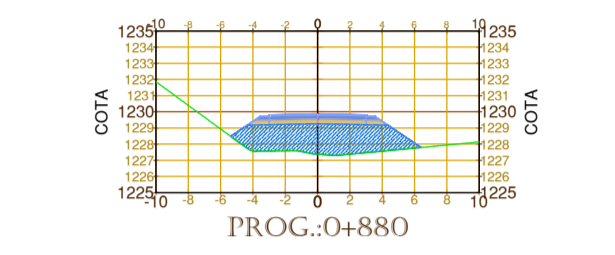
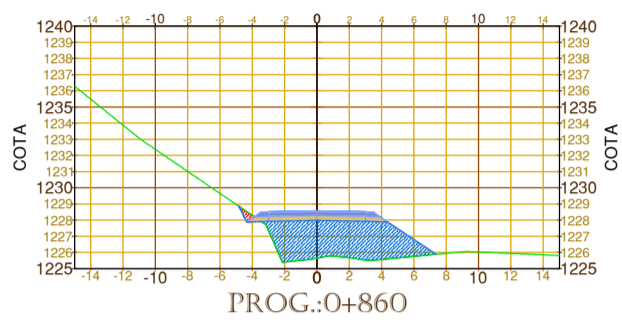
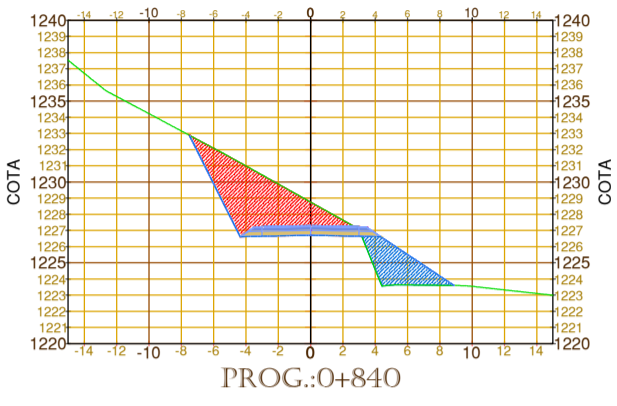
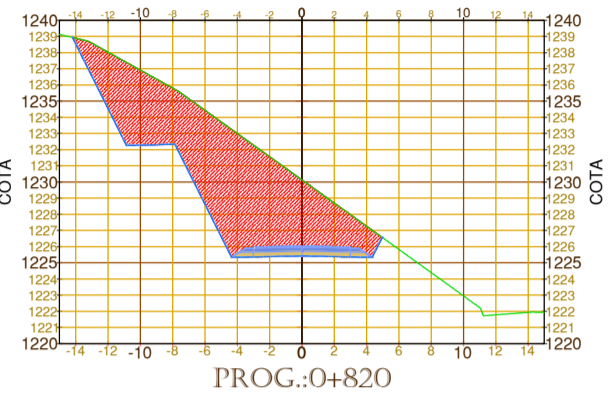
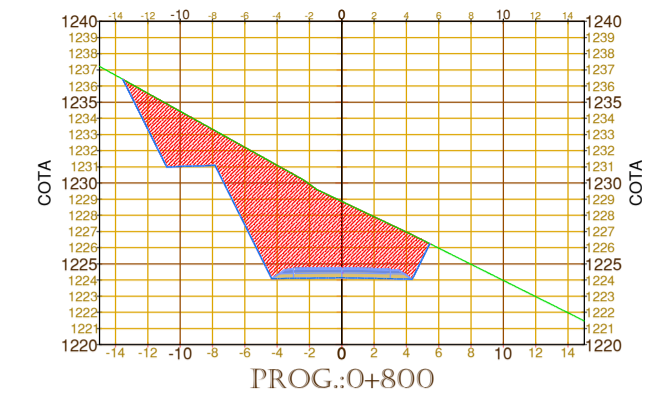
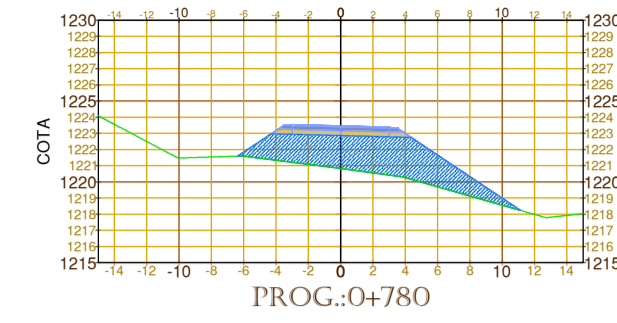
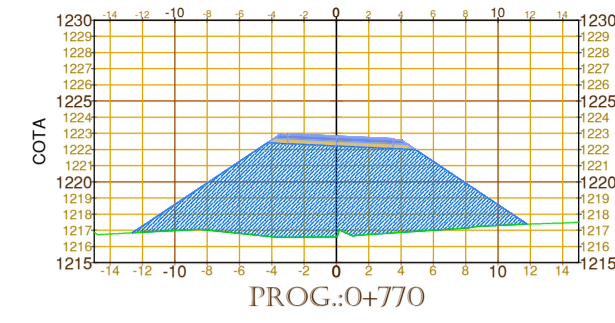
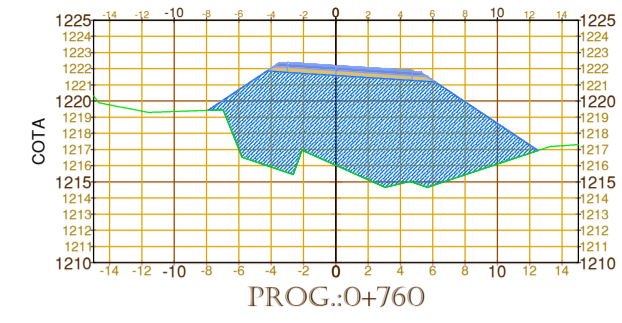
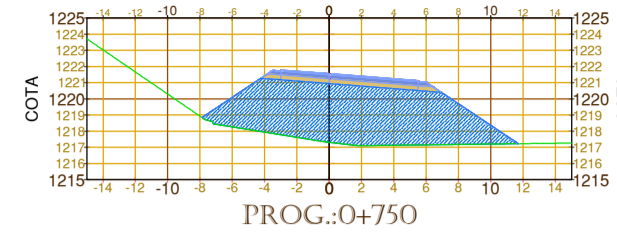
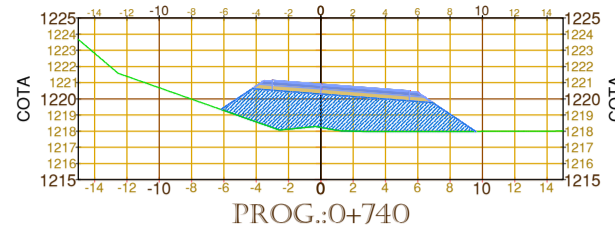

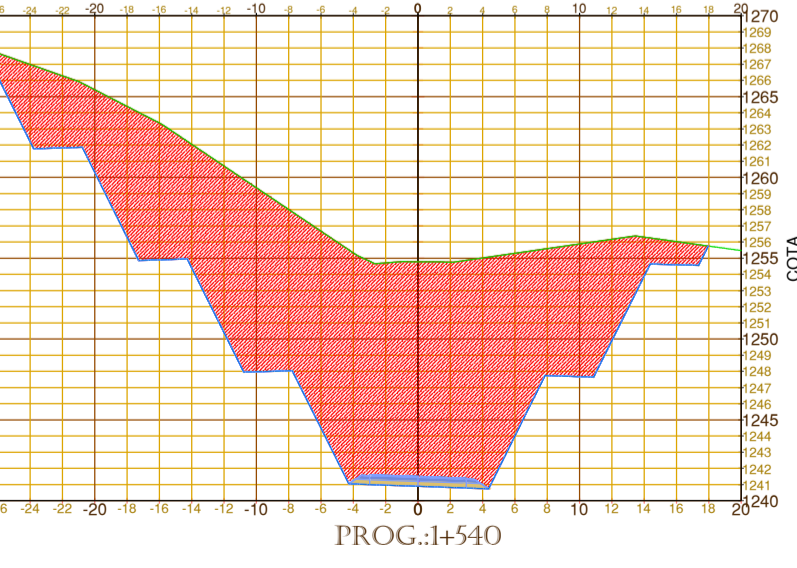
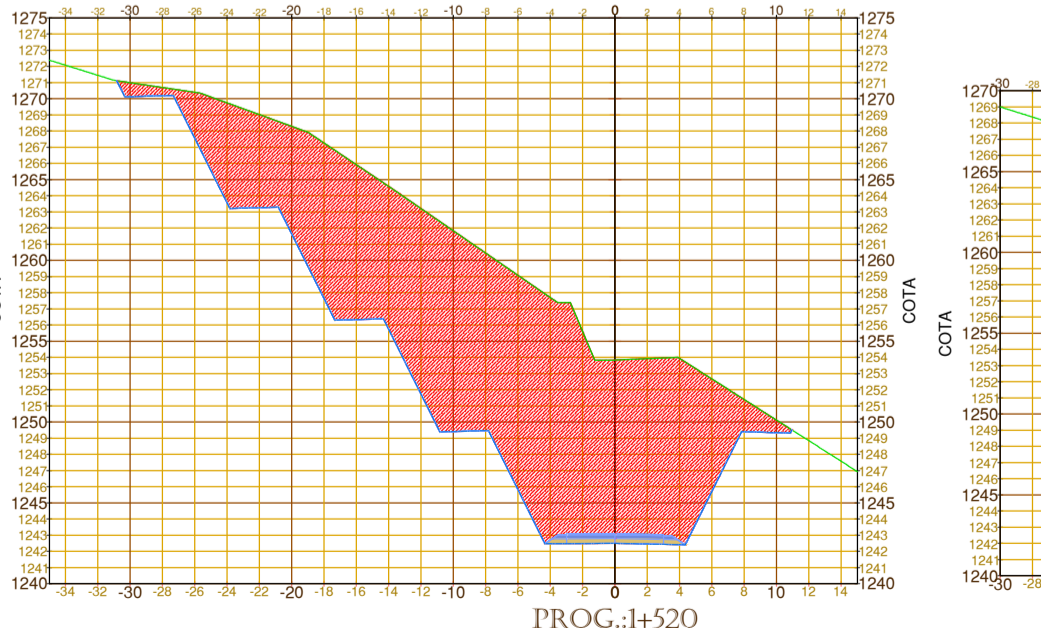
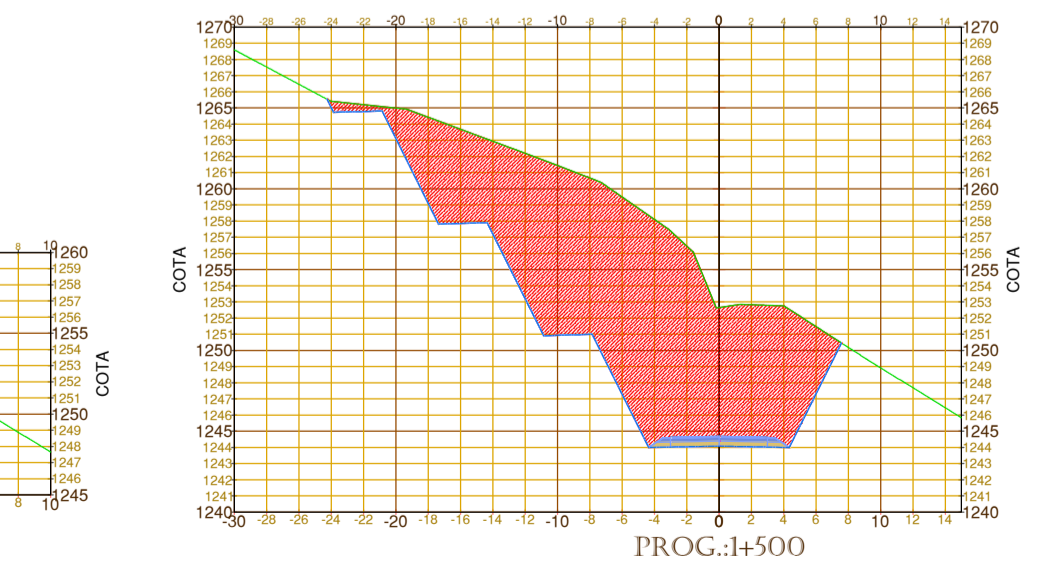
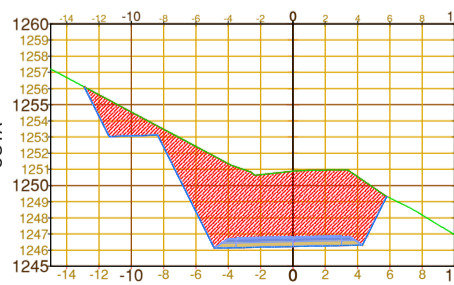
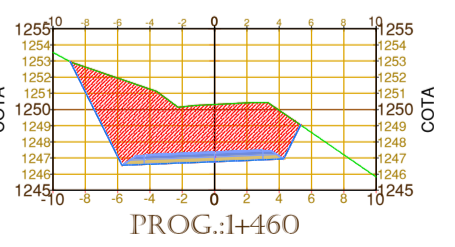
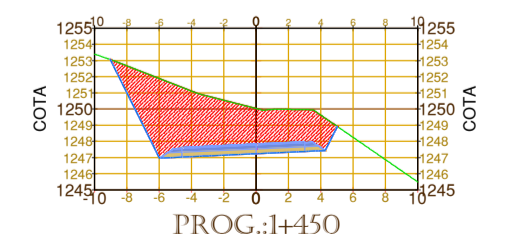
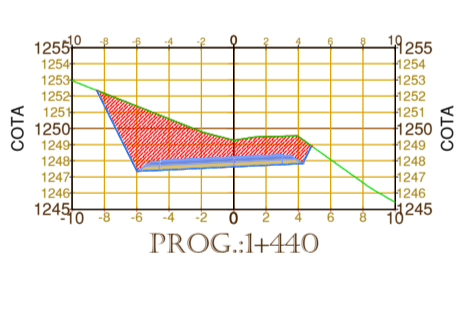
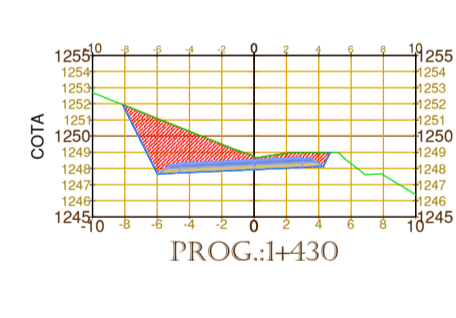
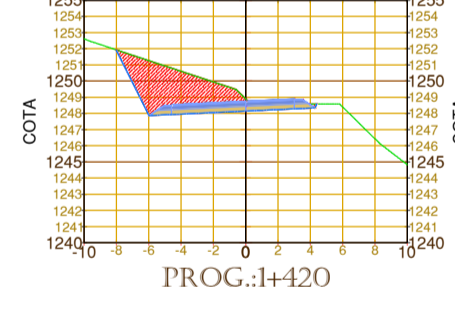
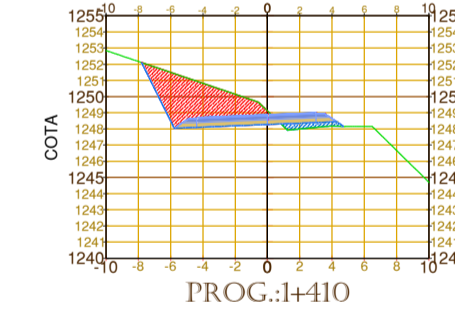
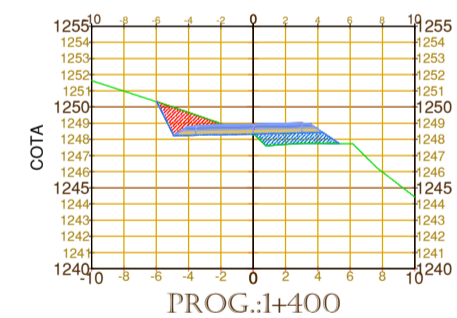
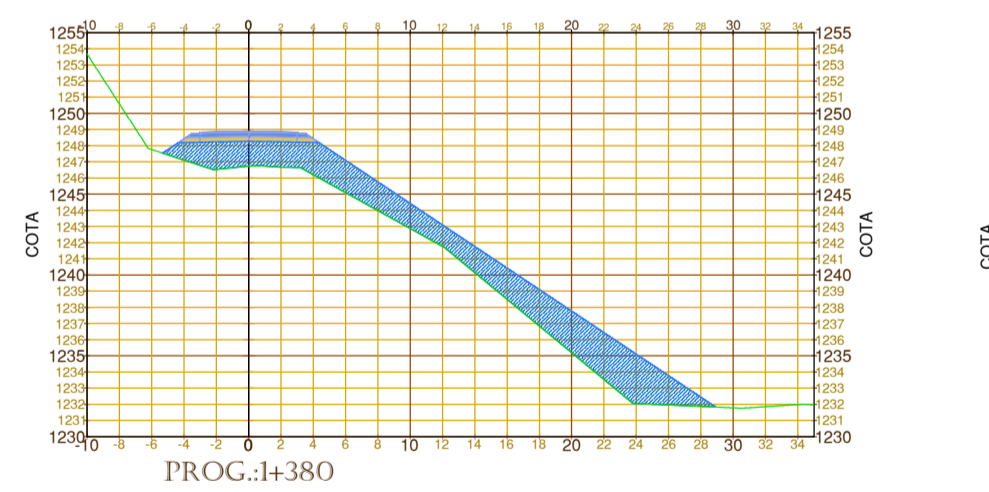
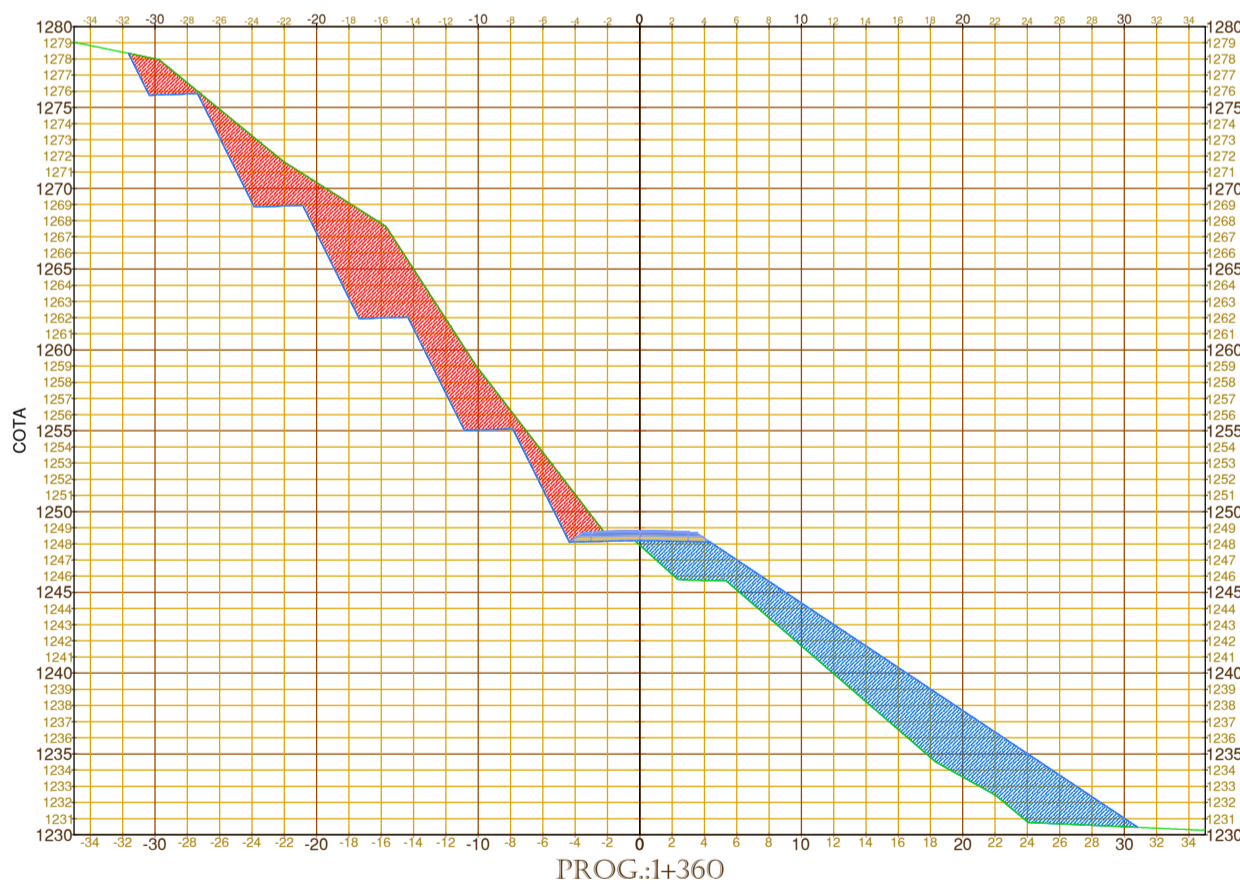
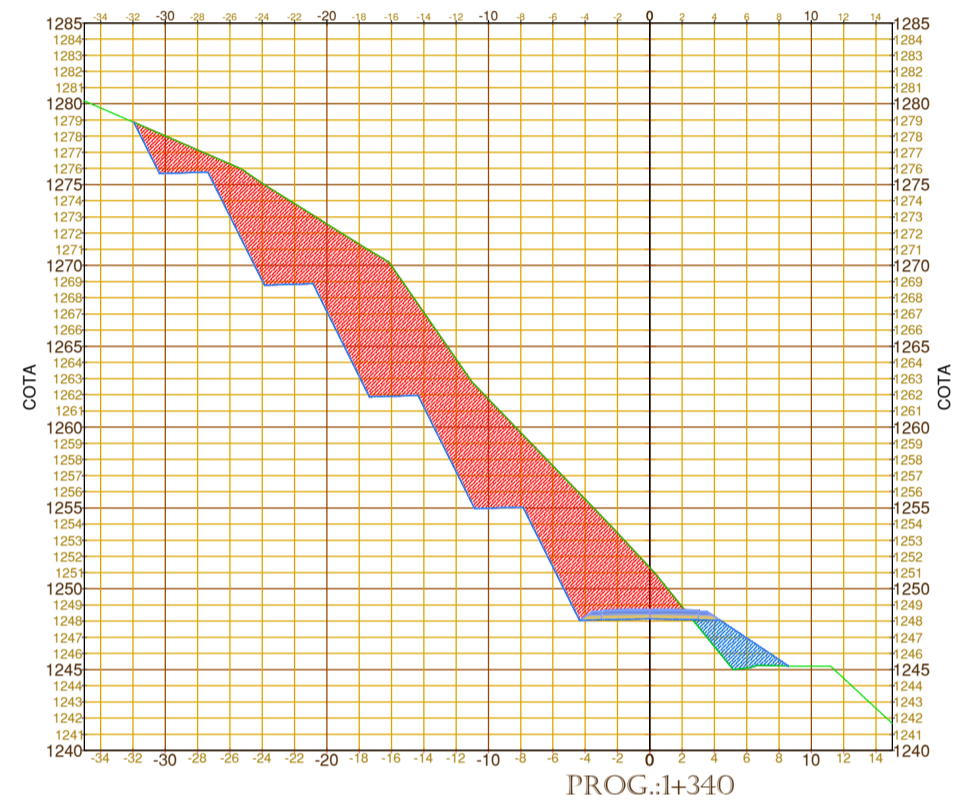
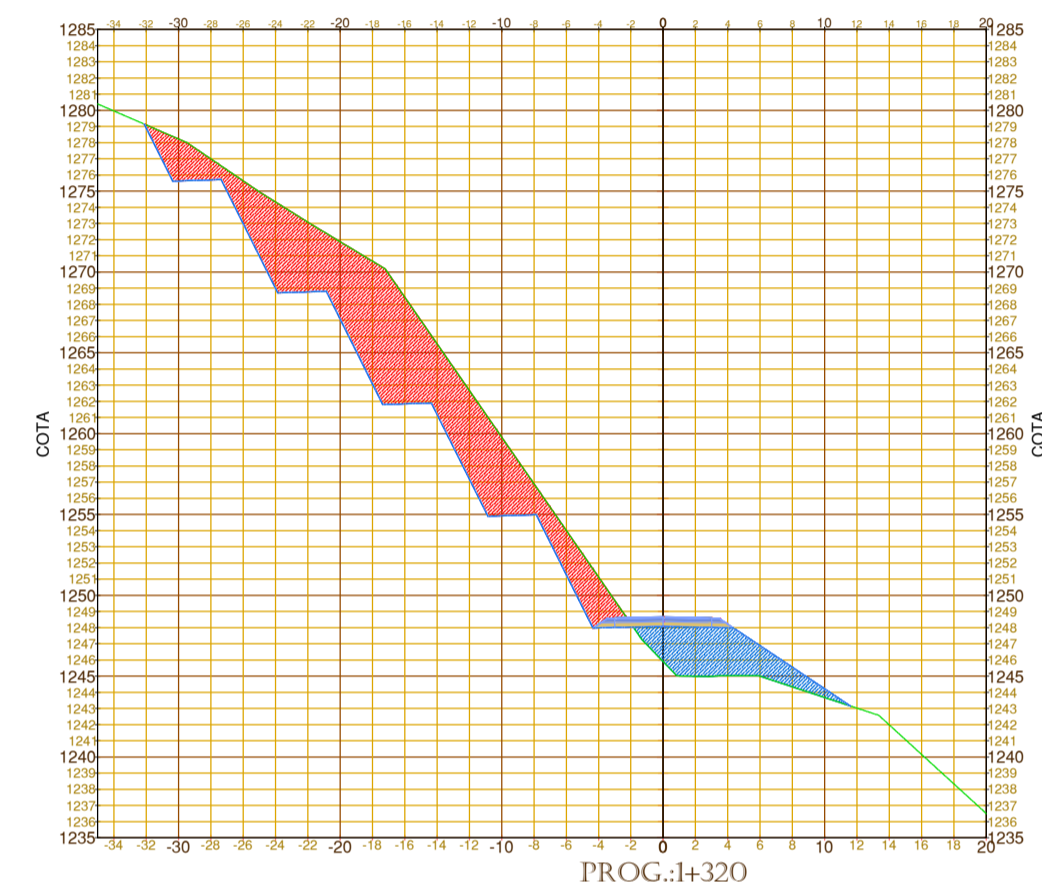
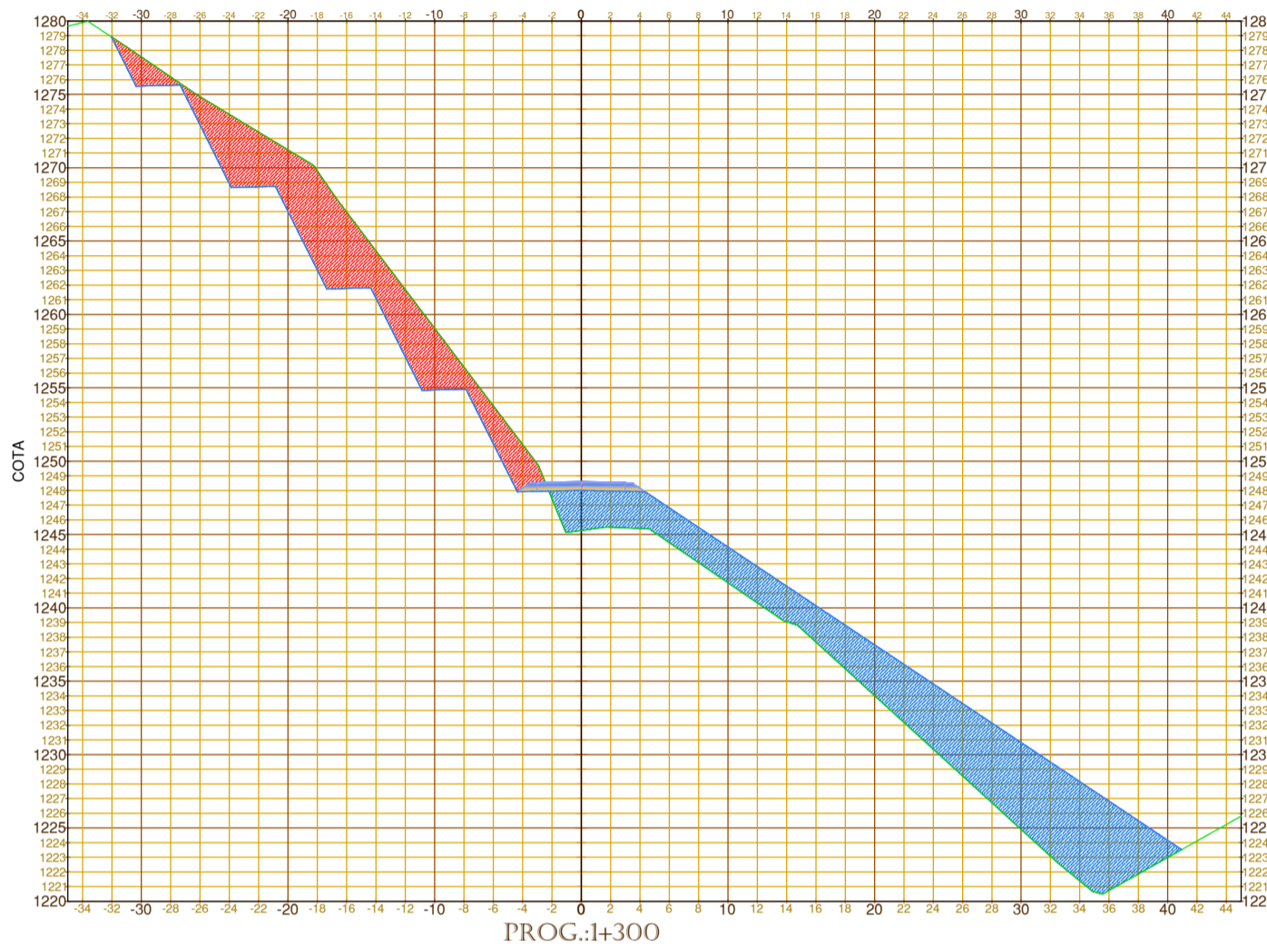
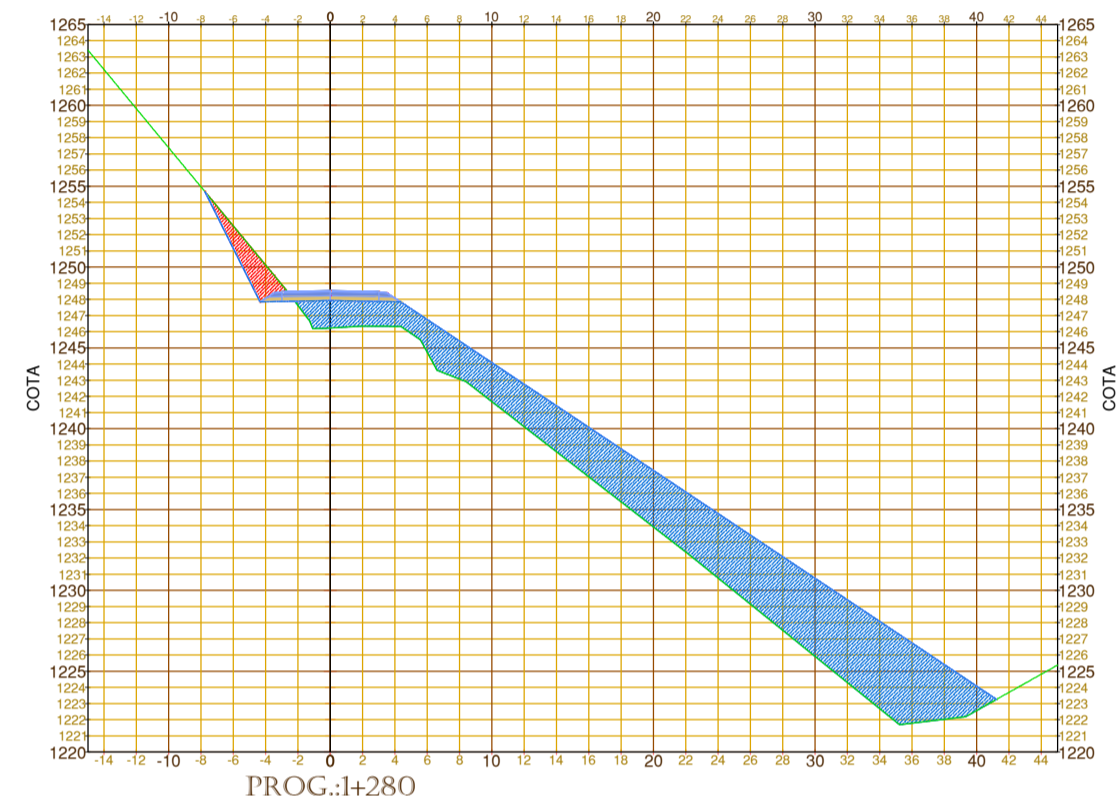
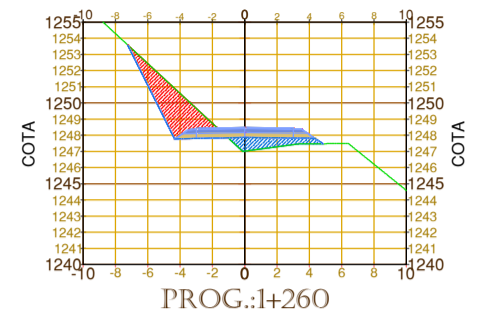
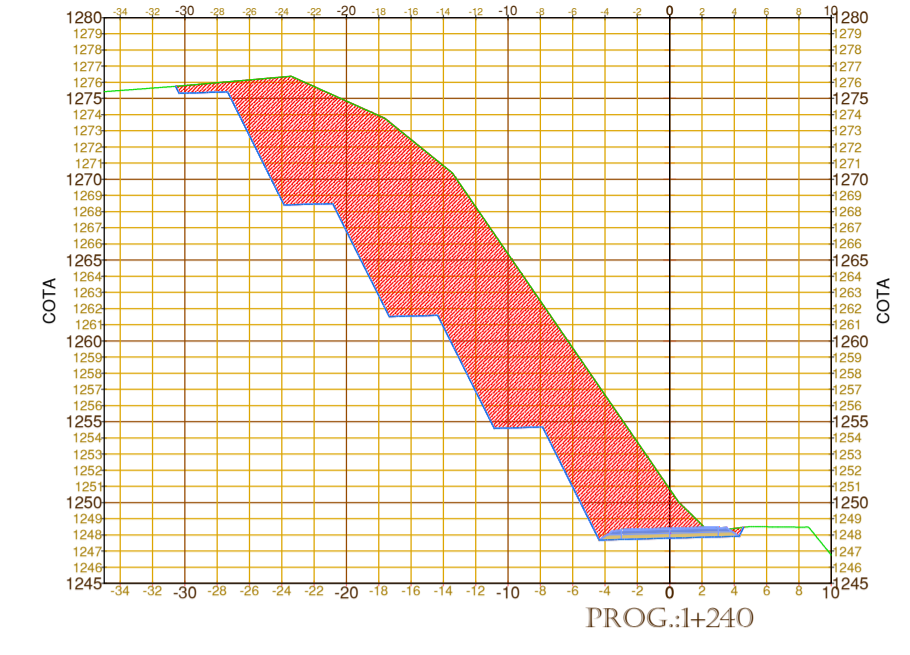
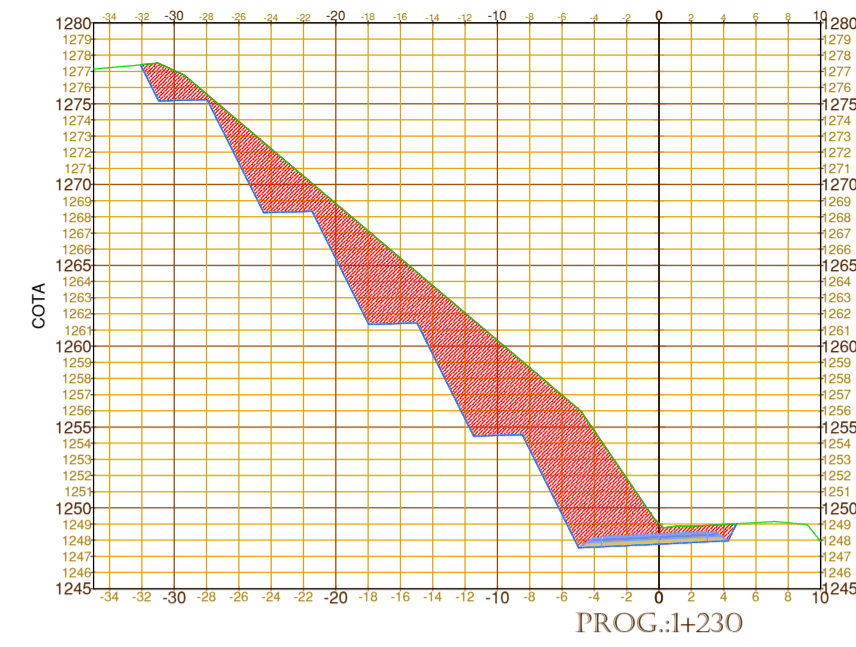
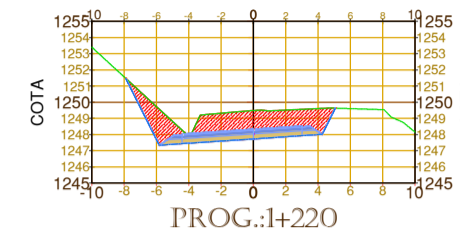
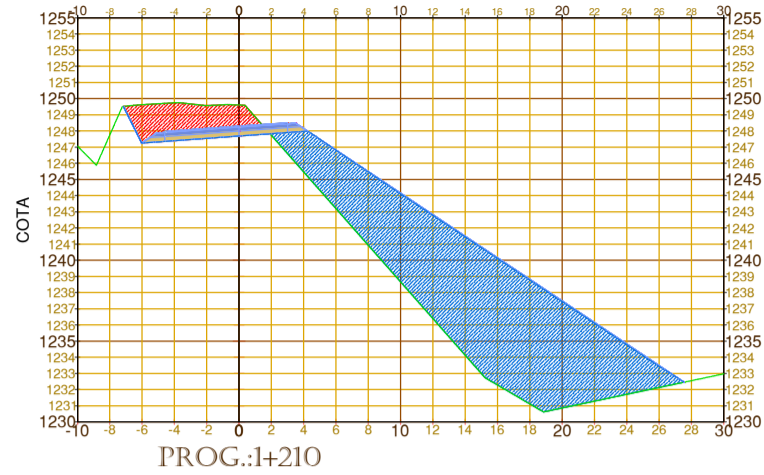
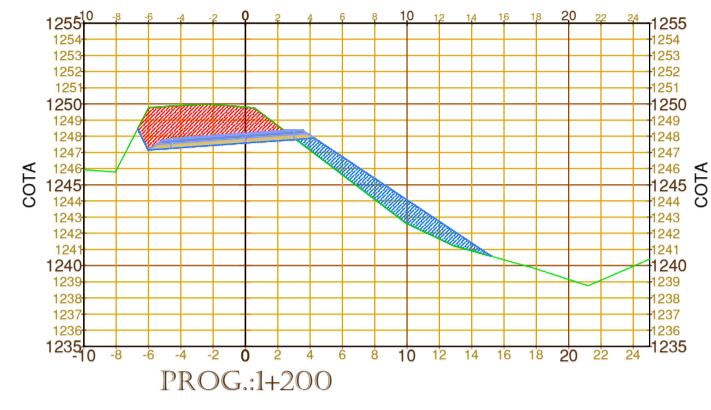

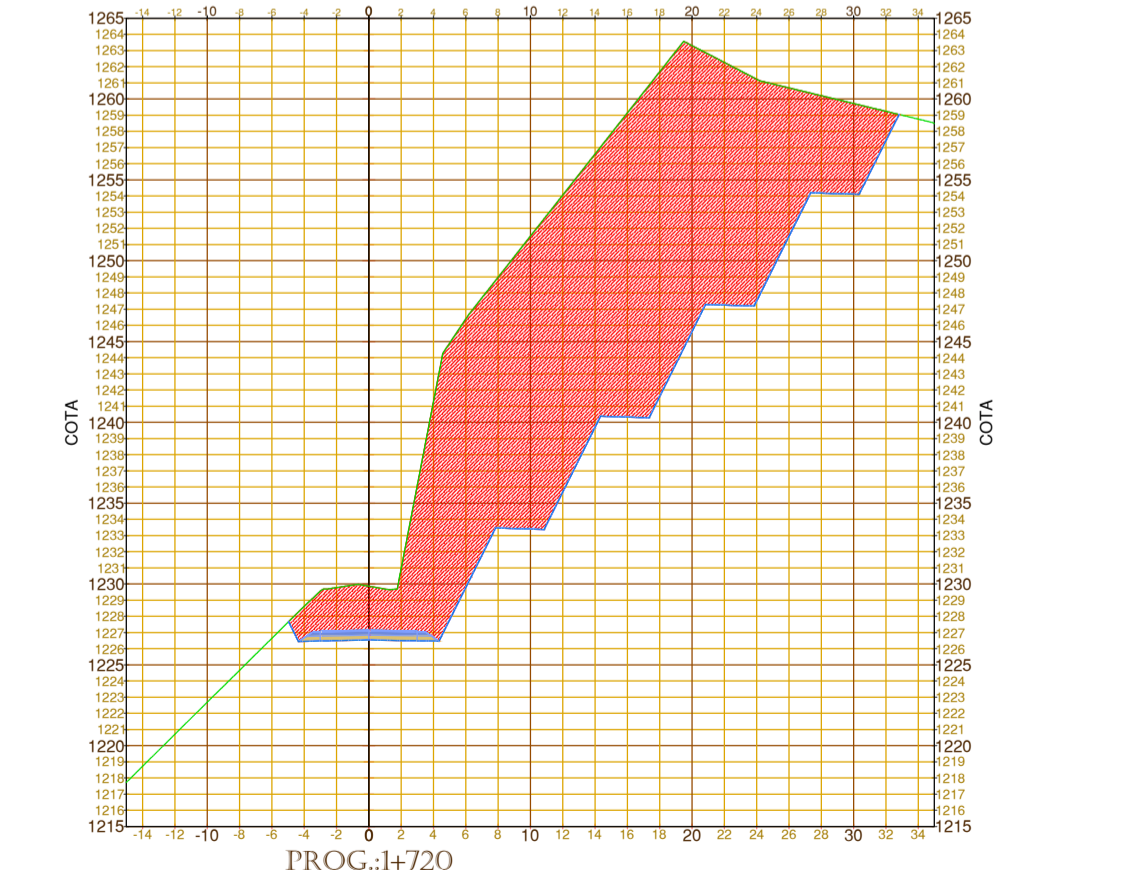
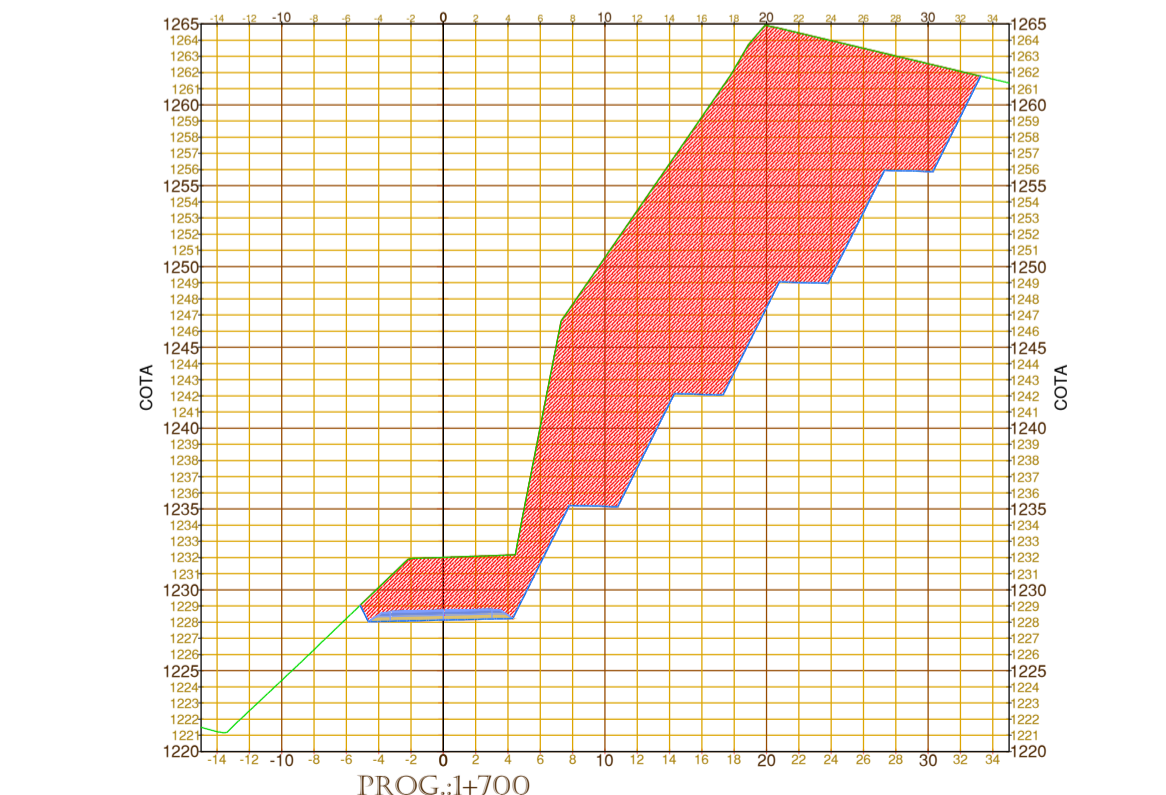
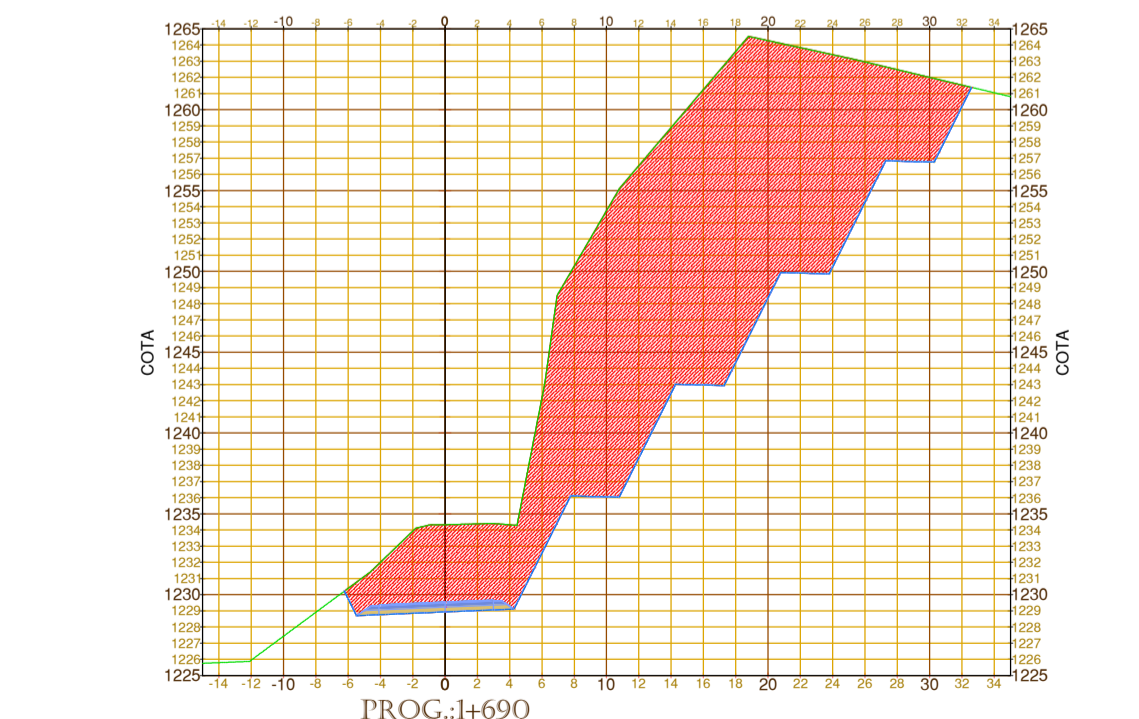
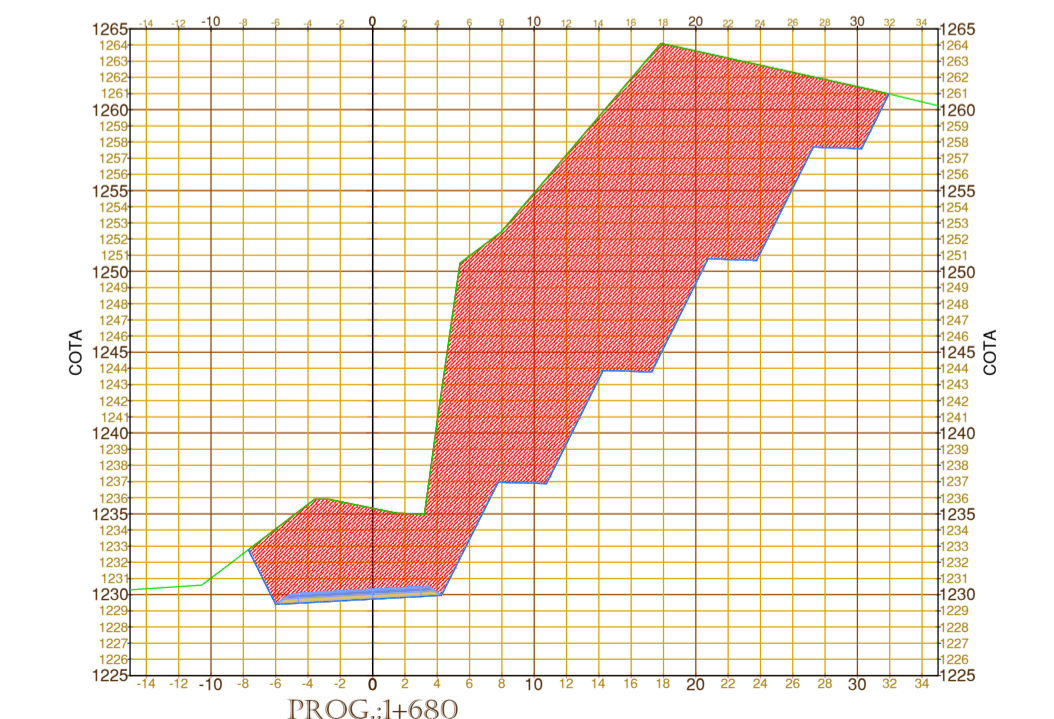
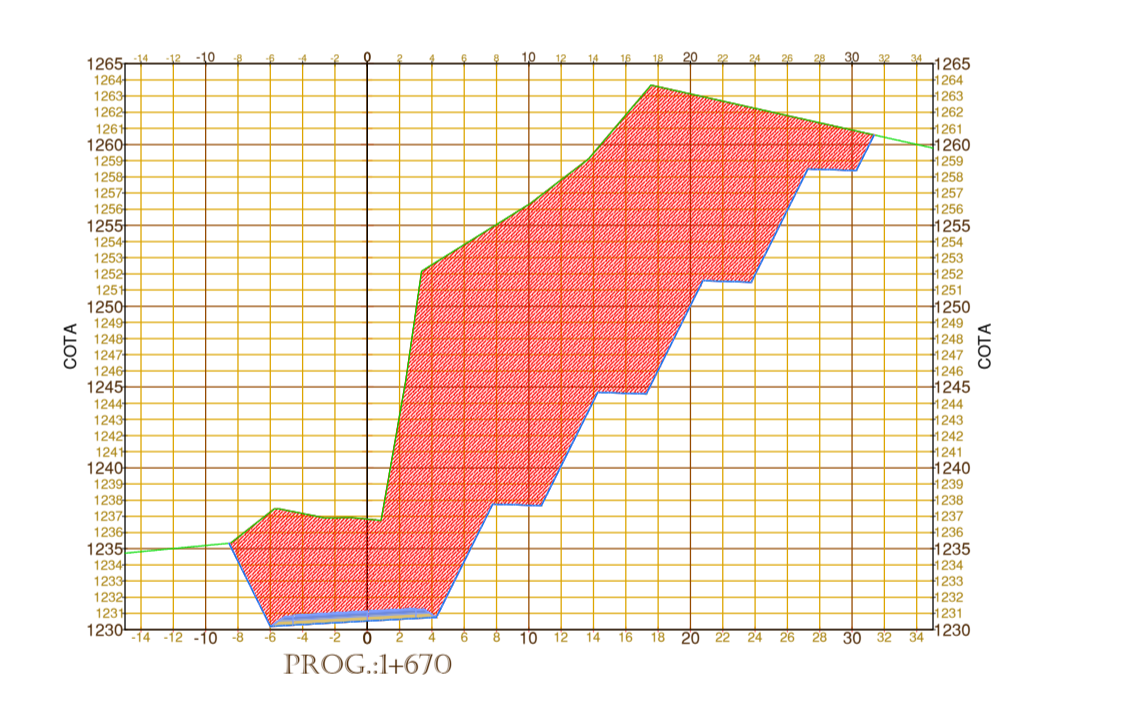
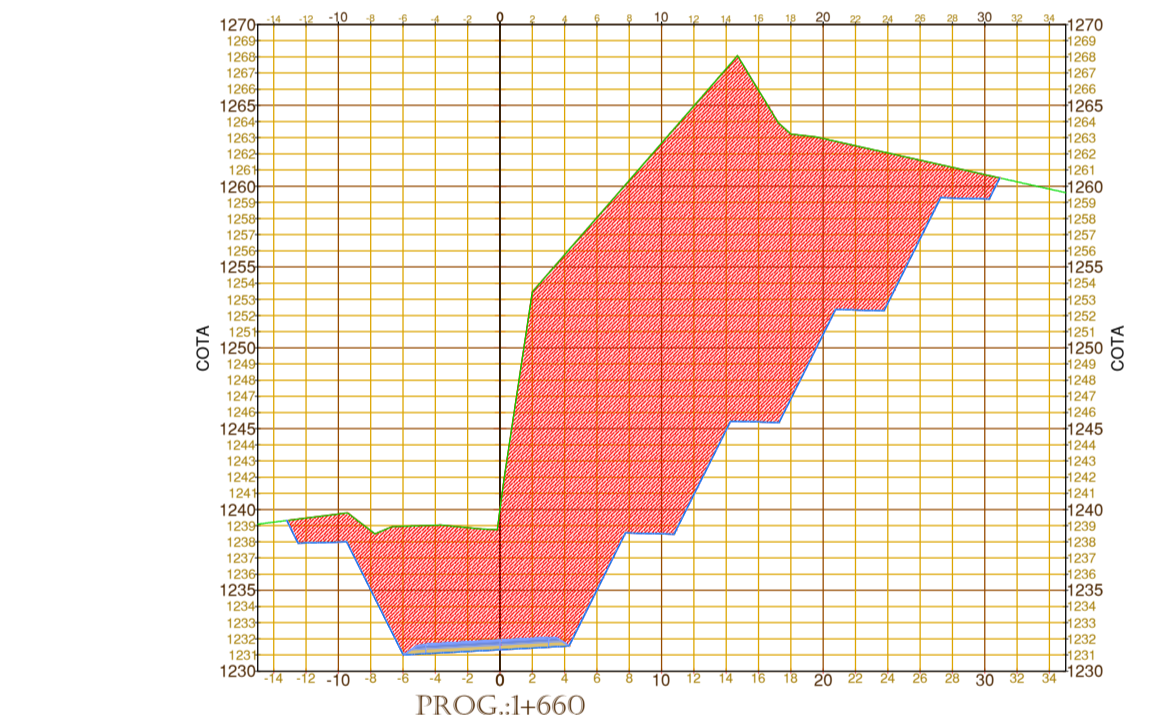
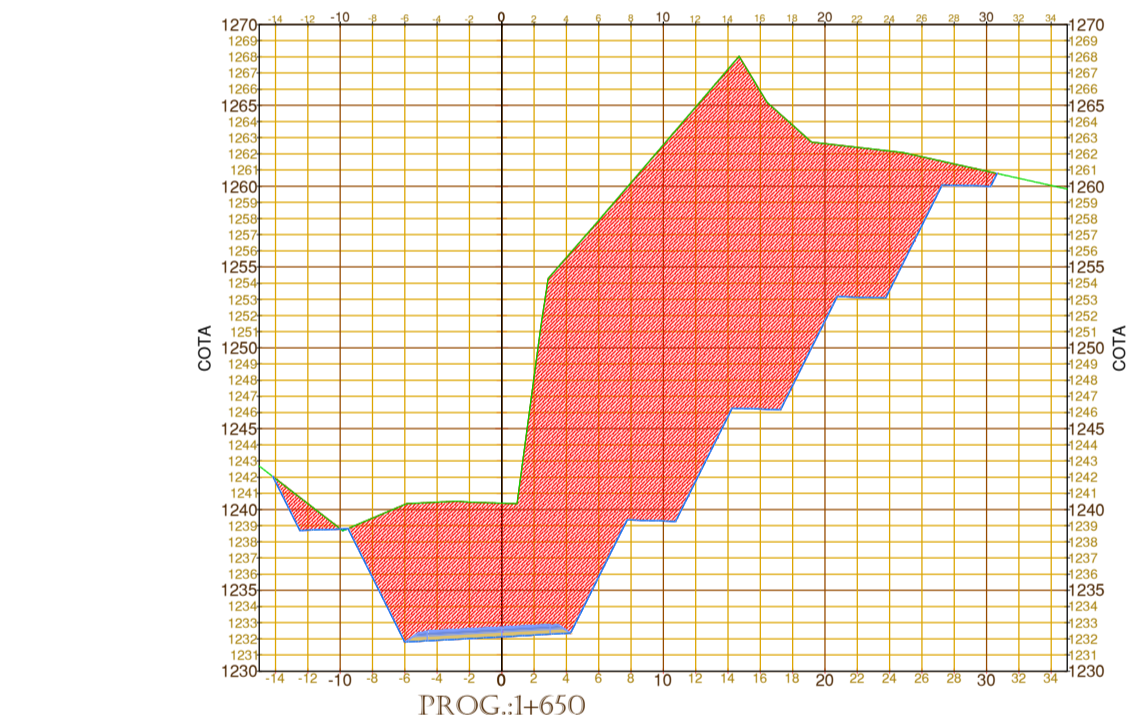
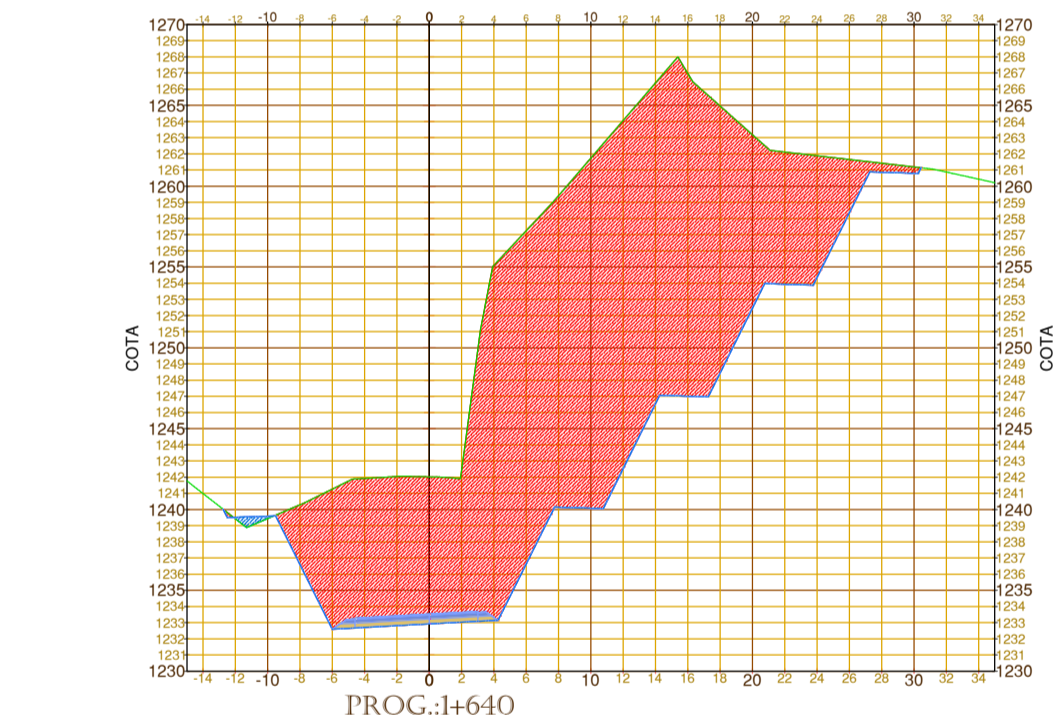
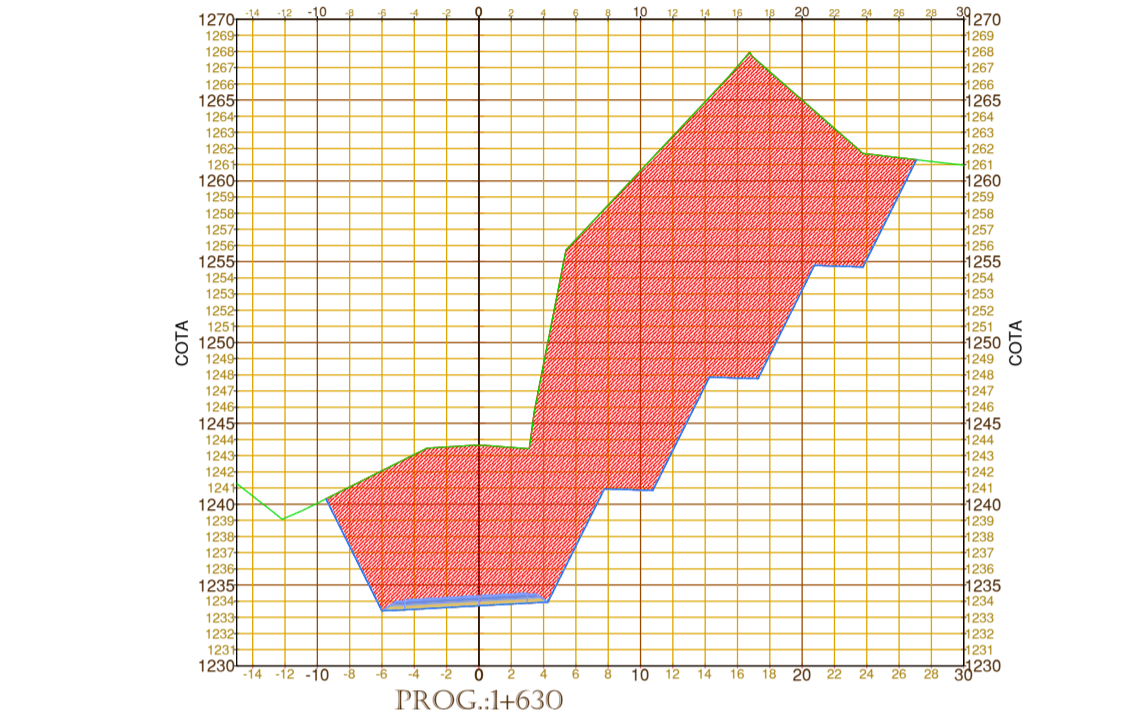
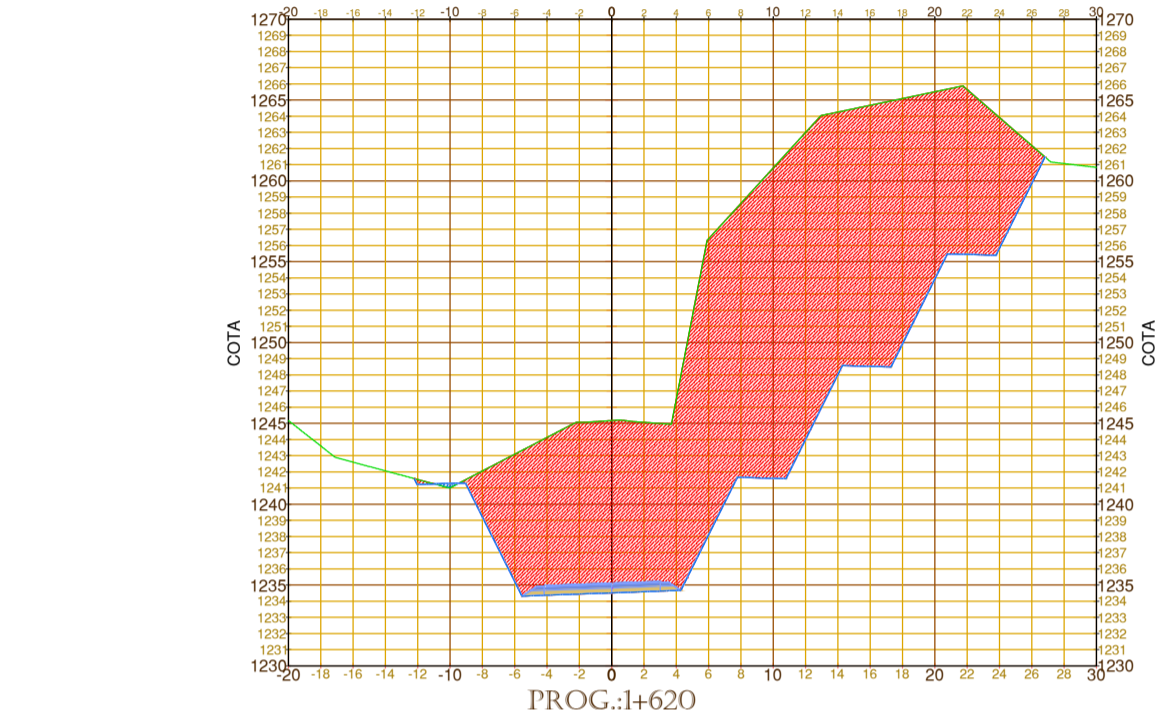
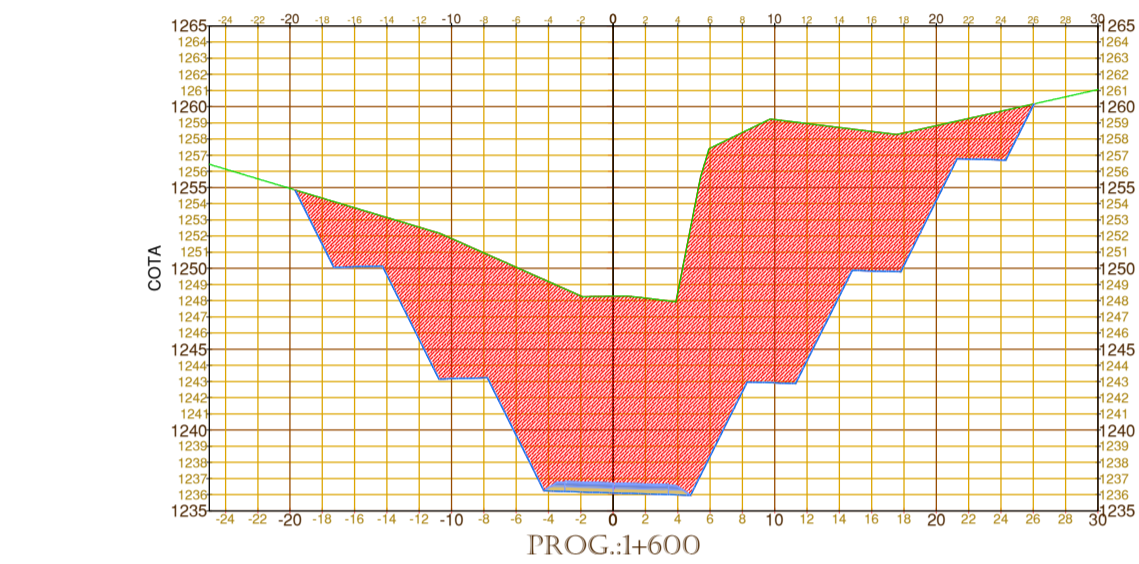
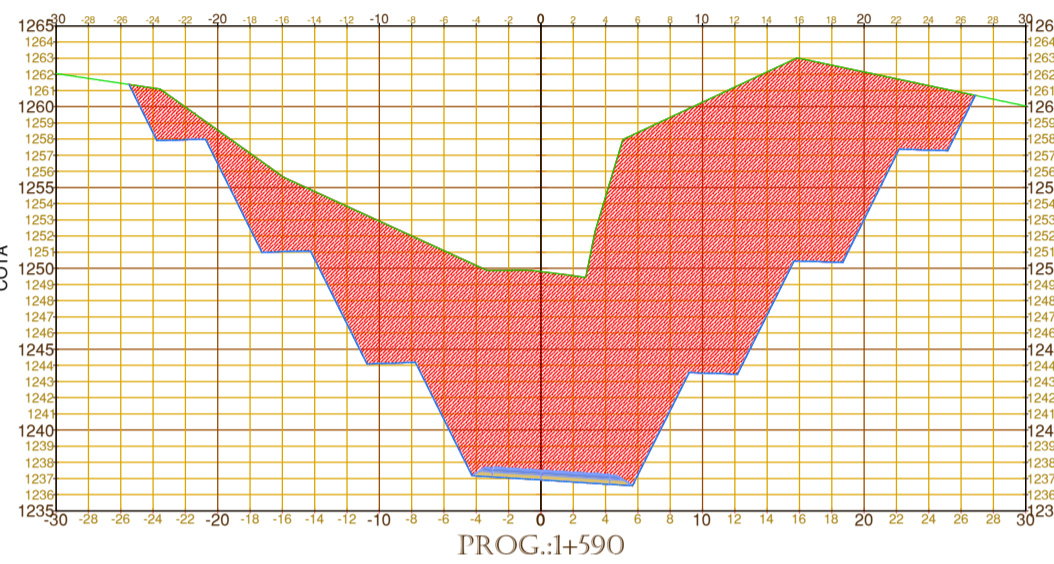
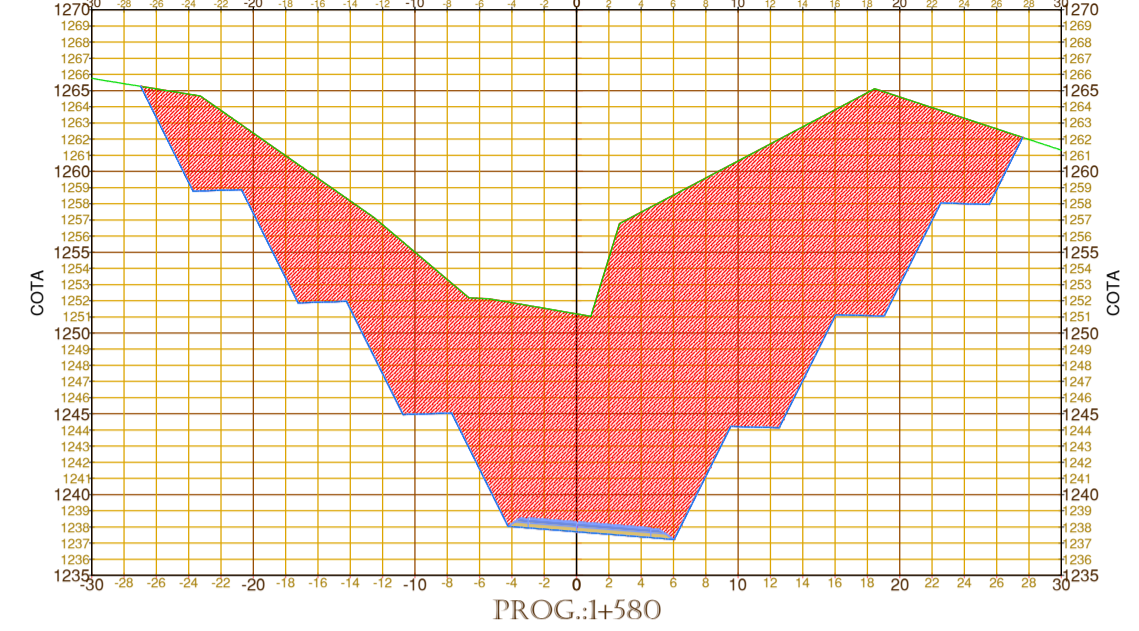
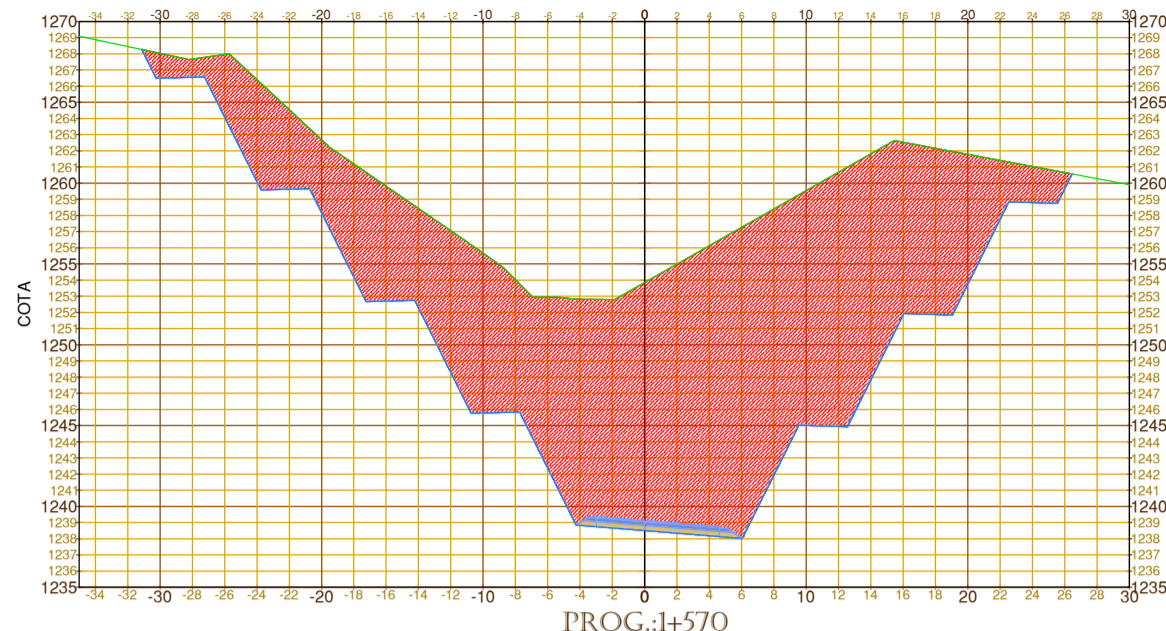
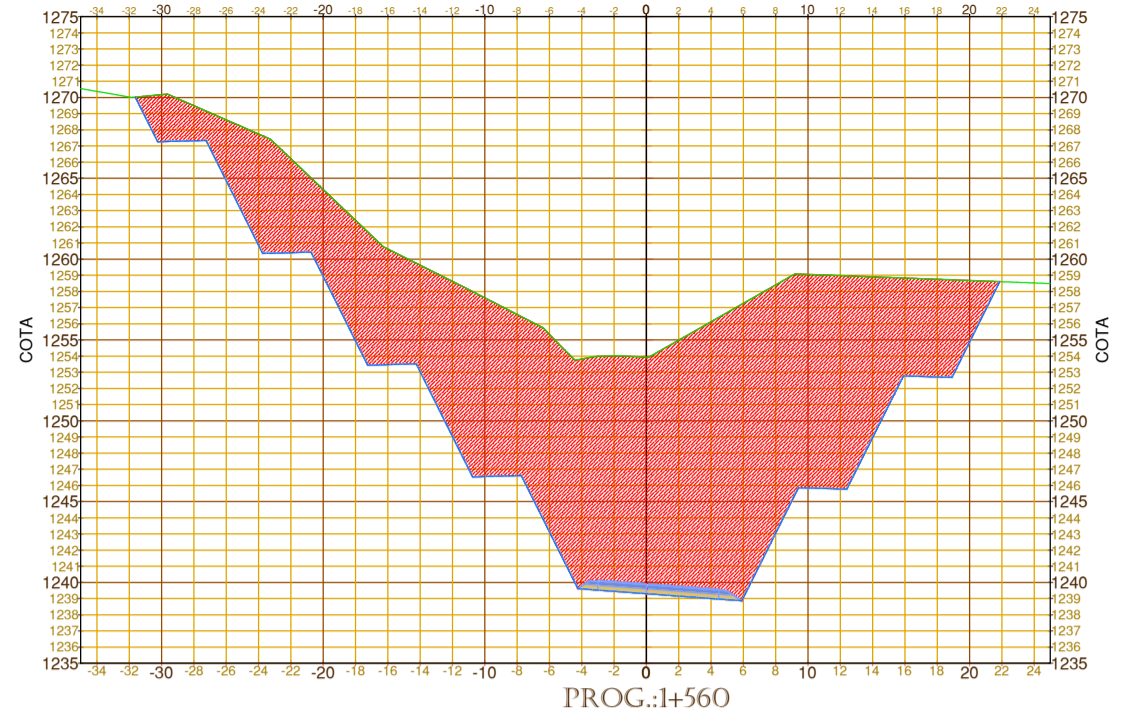
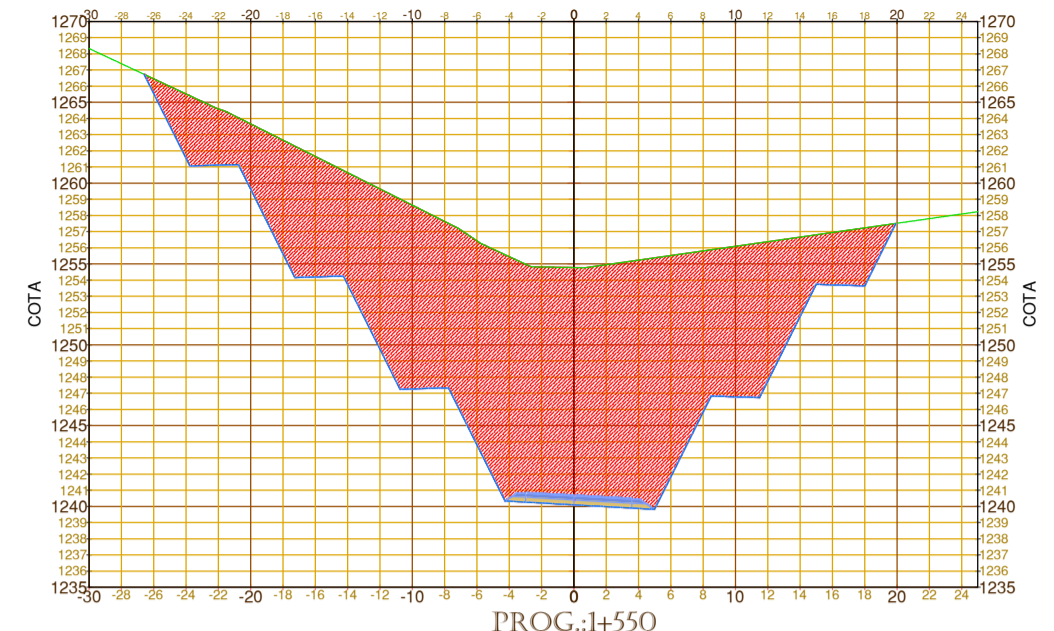

UNIVERSIDAD AUTÓNOMA JUAN MISAEL SARACHO

FACULTAD DE CIENCIAS Y TECNOLOGÍA

CARRERA: INGENIERÍA CIVIL

PROYECTO:
DISEÑO DE INGENIERÍA DEL TRAMO CRUCE LOS NARANJOS - CRUCE SERERE LIMAL

CARACTER:
PLANO DE SECCIONES TRANSVERSALES

MATERIA:
CIV - 502 PROYECTO DE INGENIERIA CIVIL II

ESTUDIANTE:
MARIO ALBERTO MARTINEZ SALINAS

FECHA:
17 DE SEPTIEMBRE DE 2019

ESCALA:
1:300

Nº DE PLANO

4/10

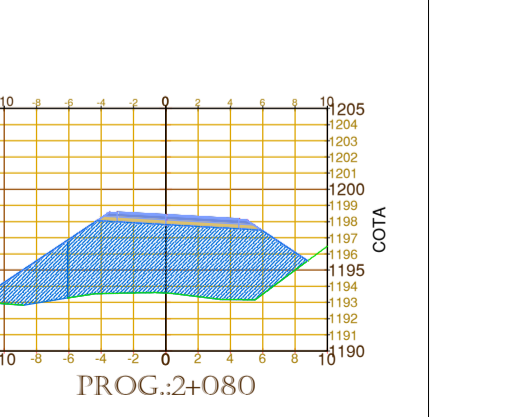
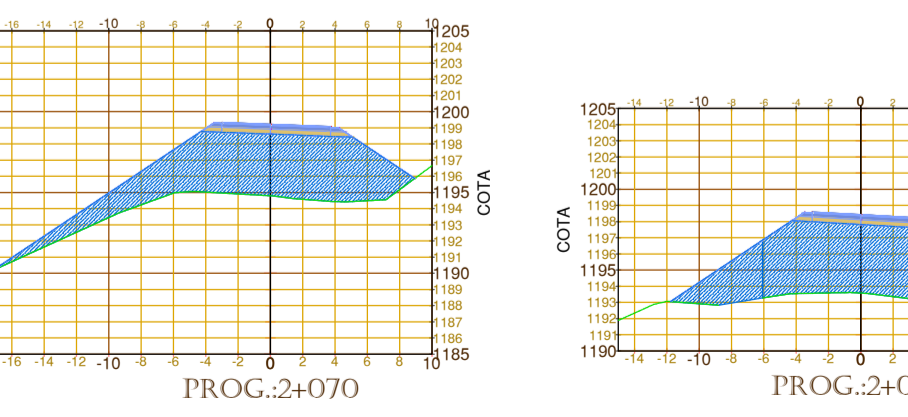
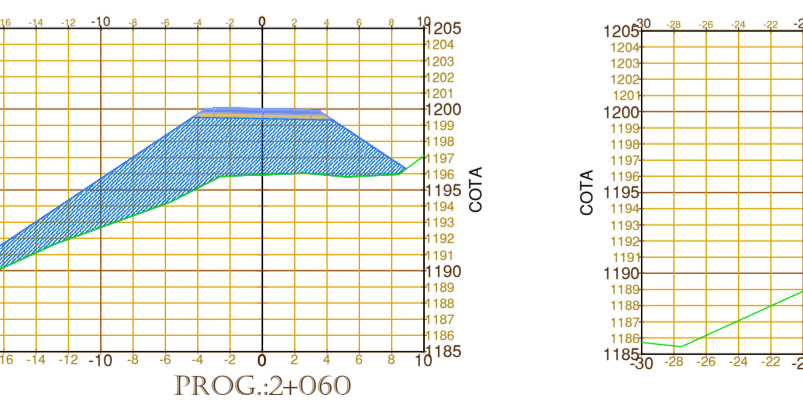
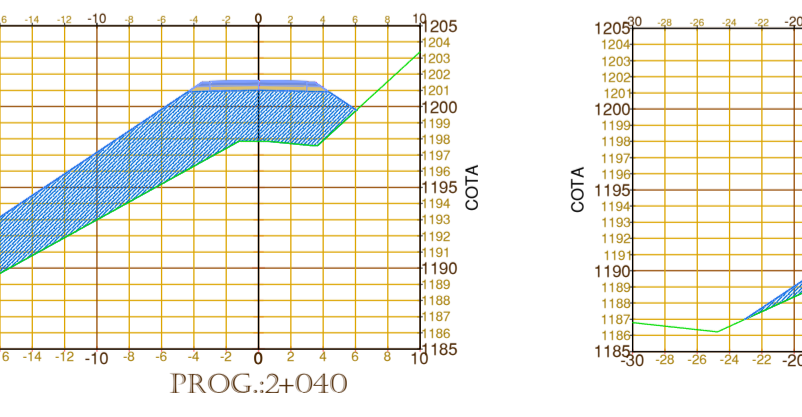
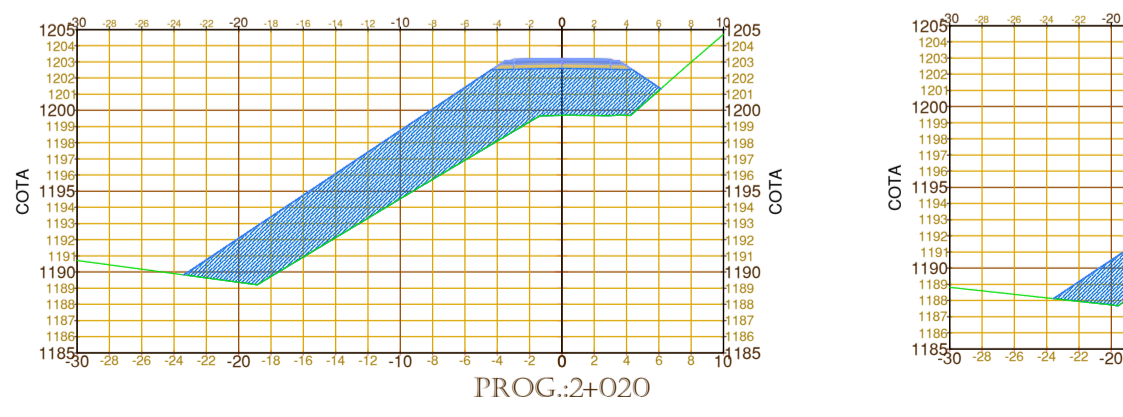
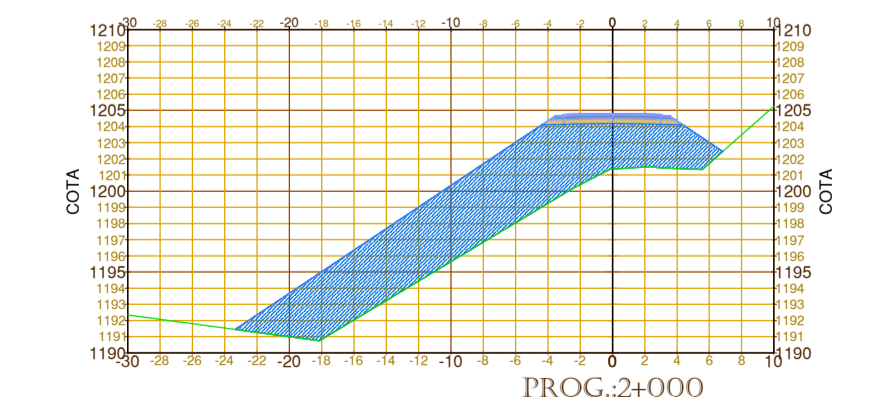
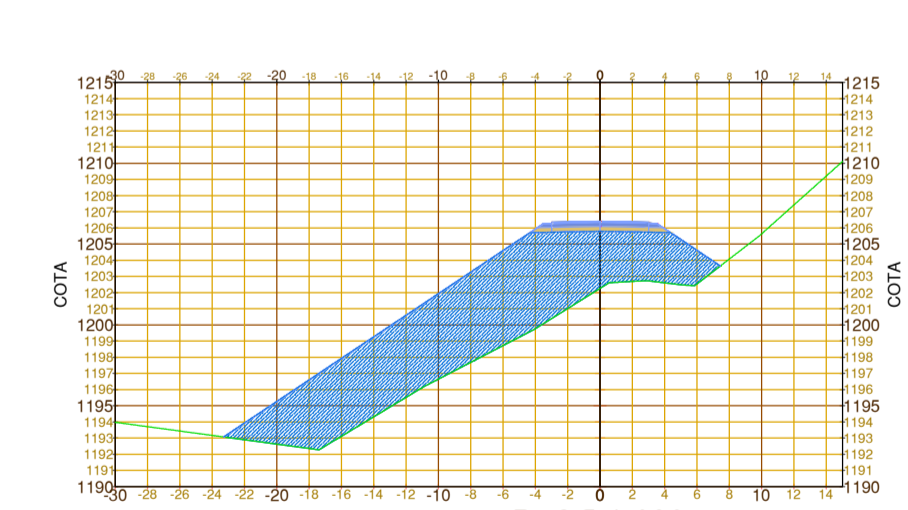
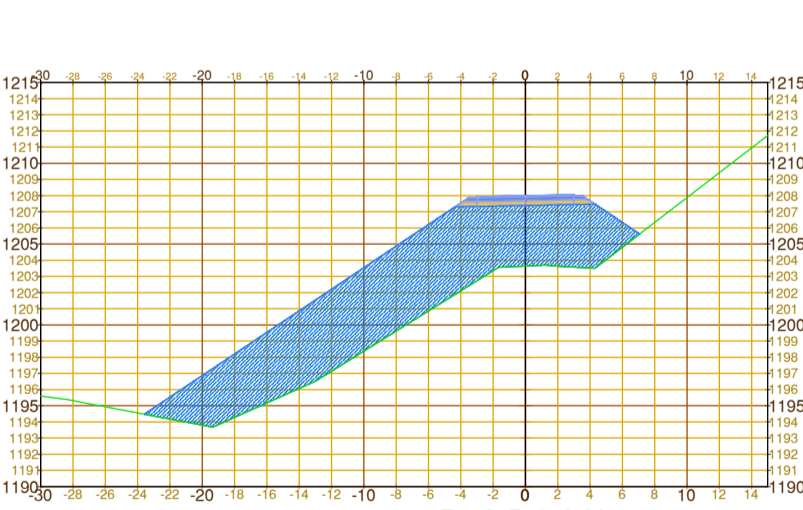
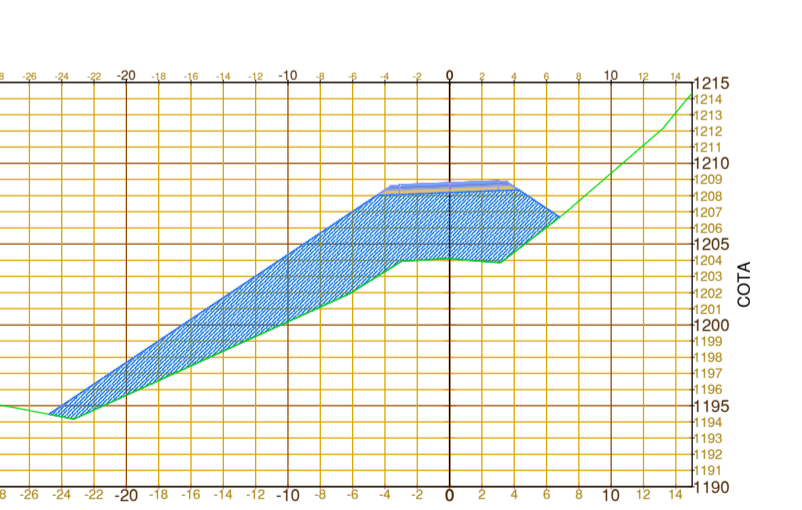
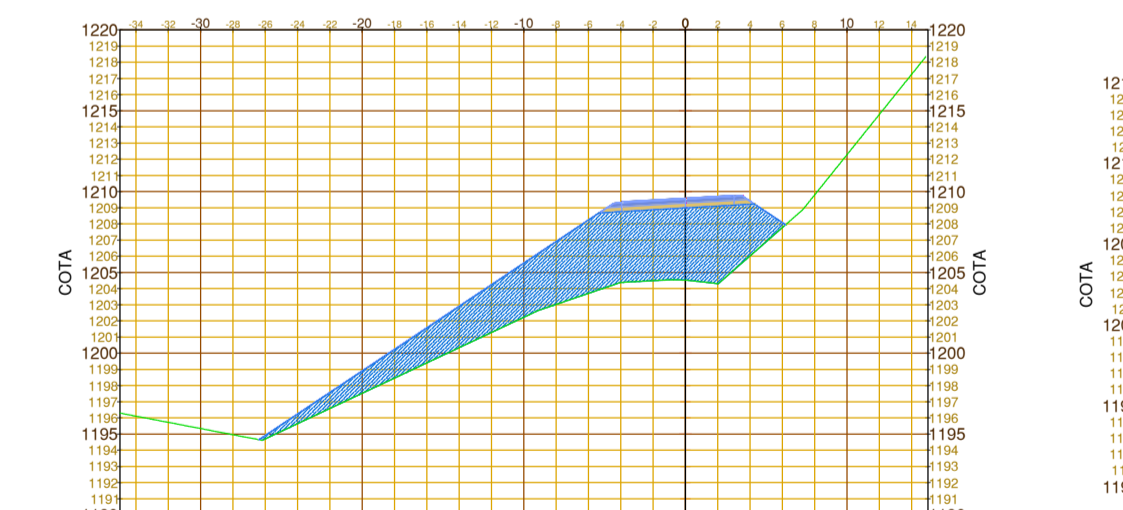
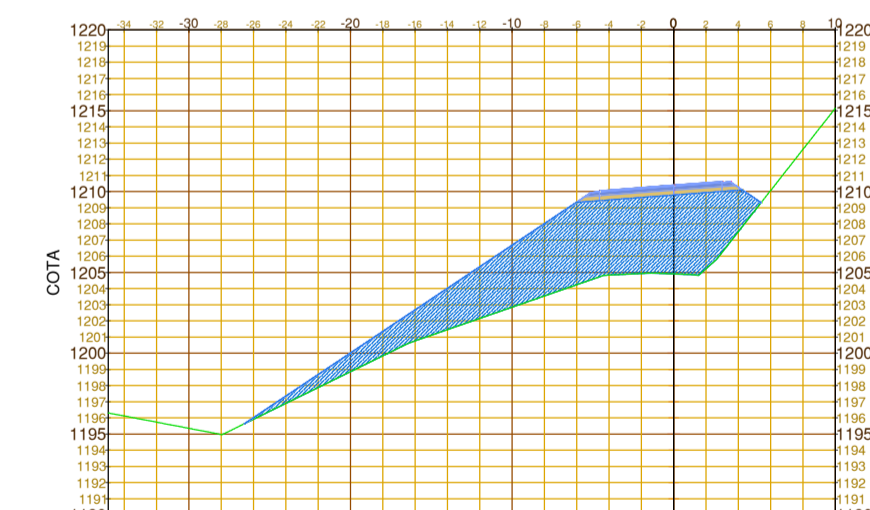
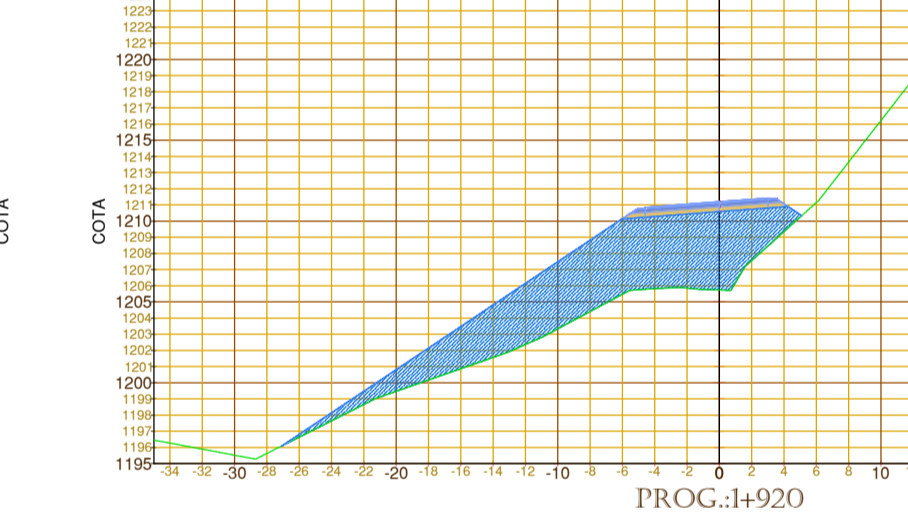
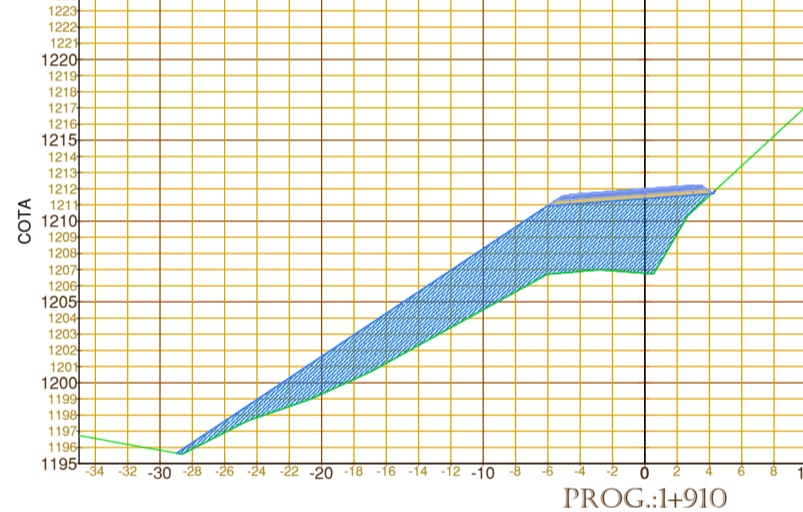
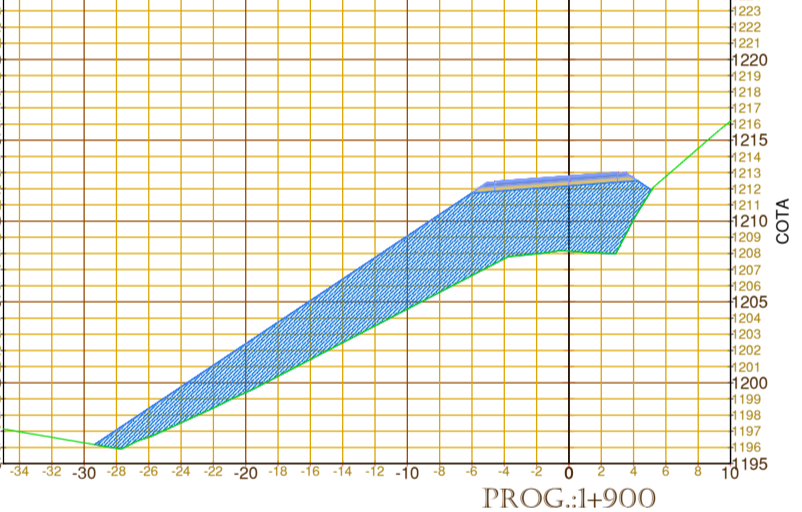
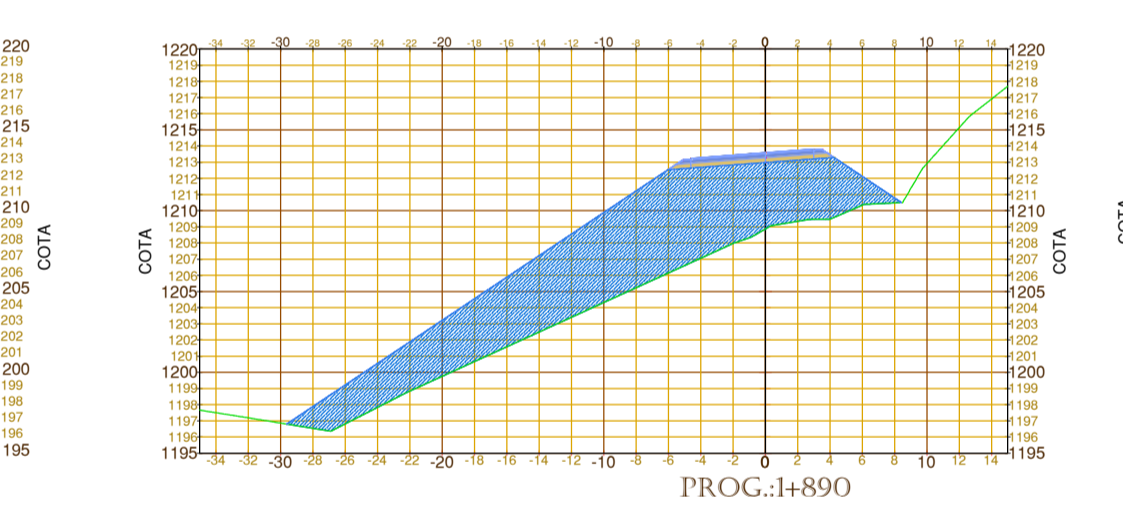
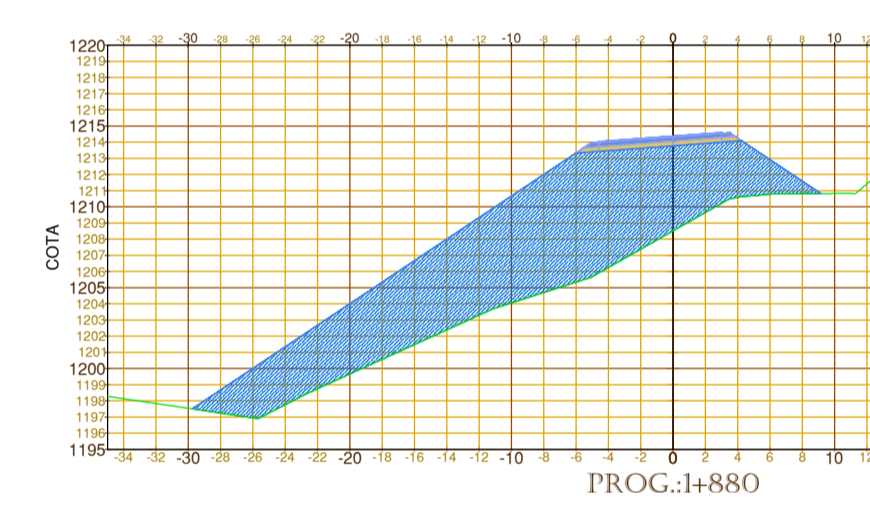
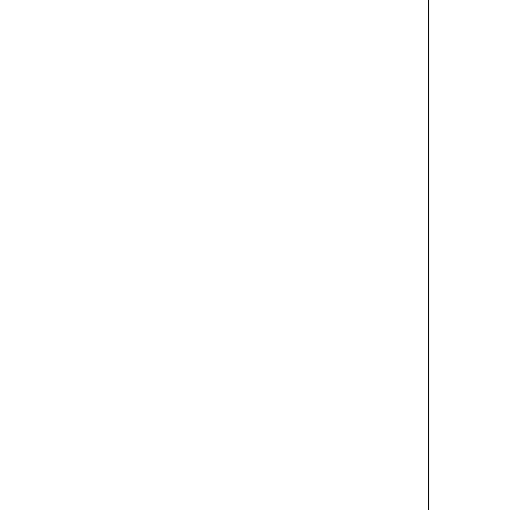
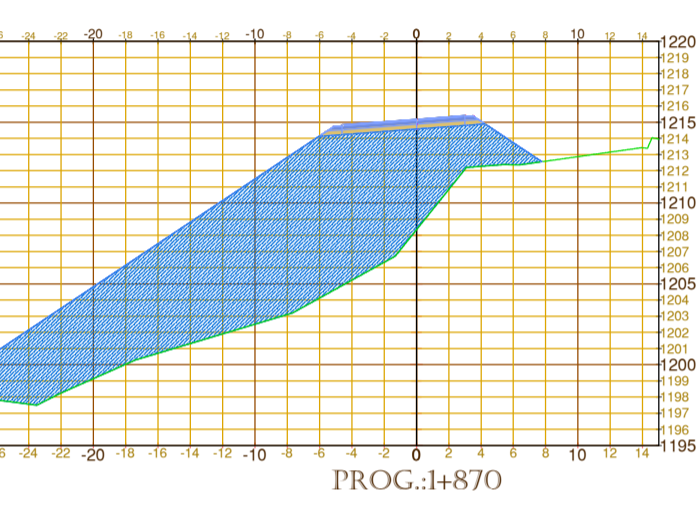
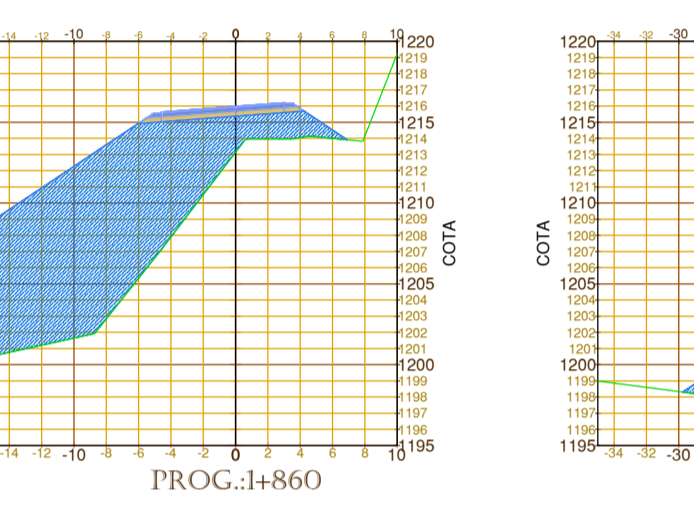
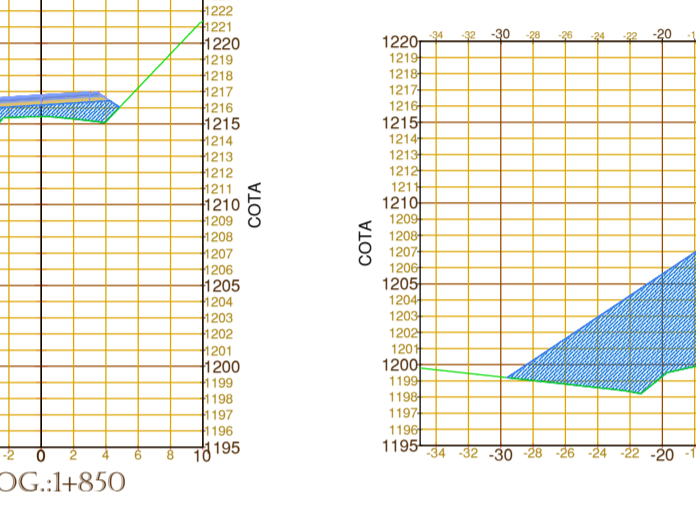
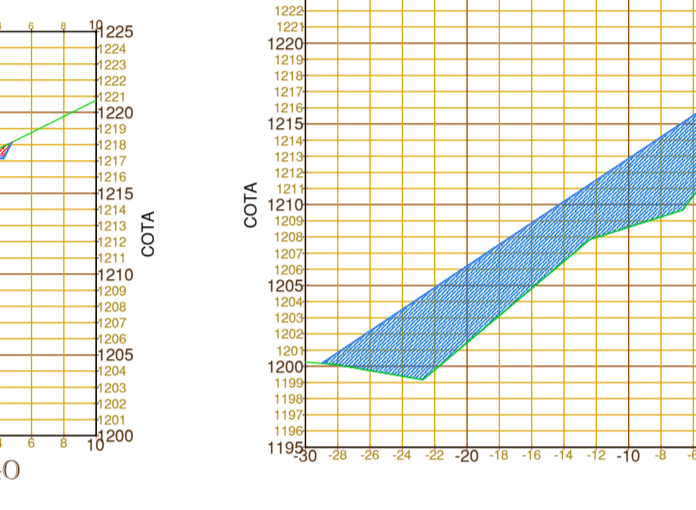
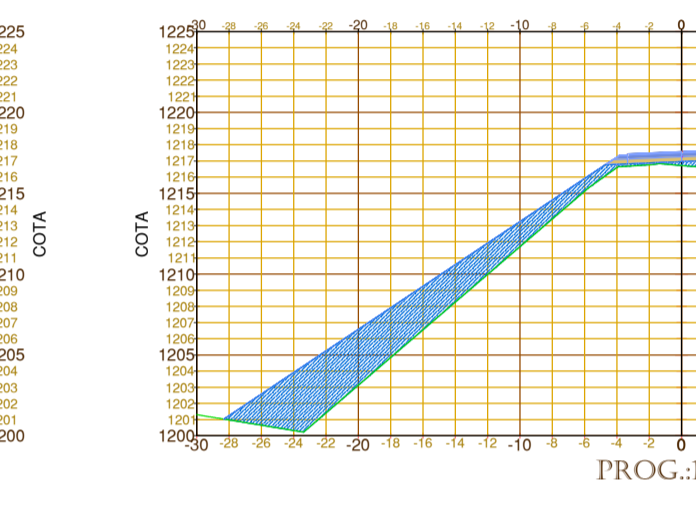
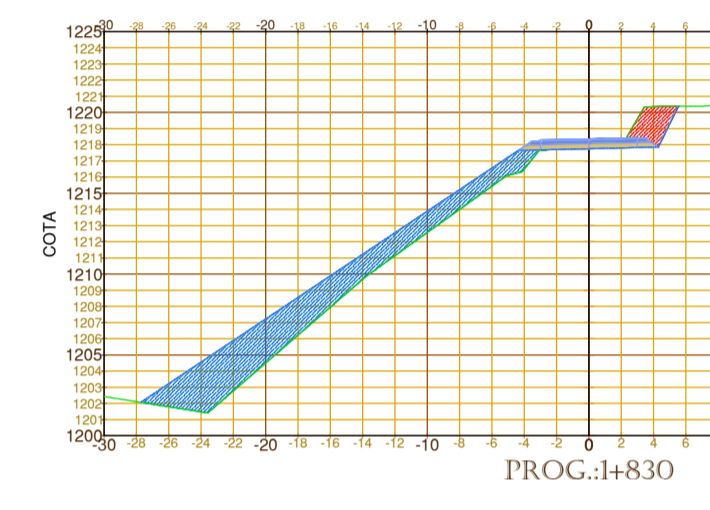
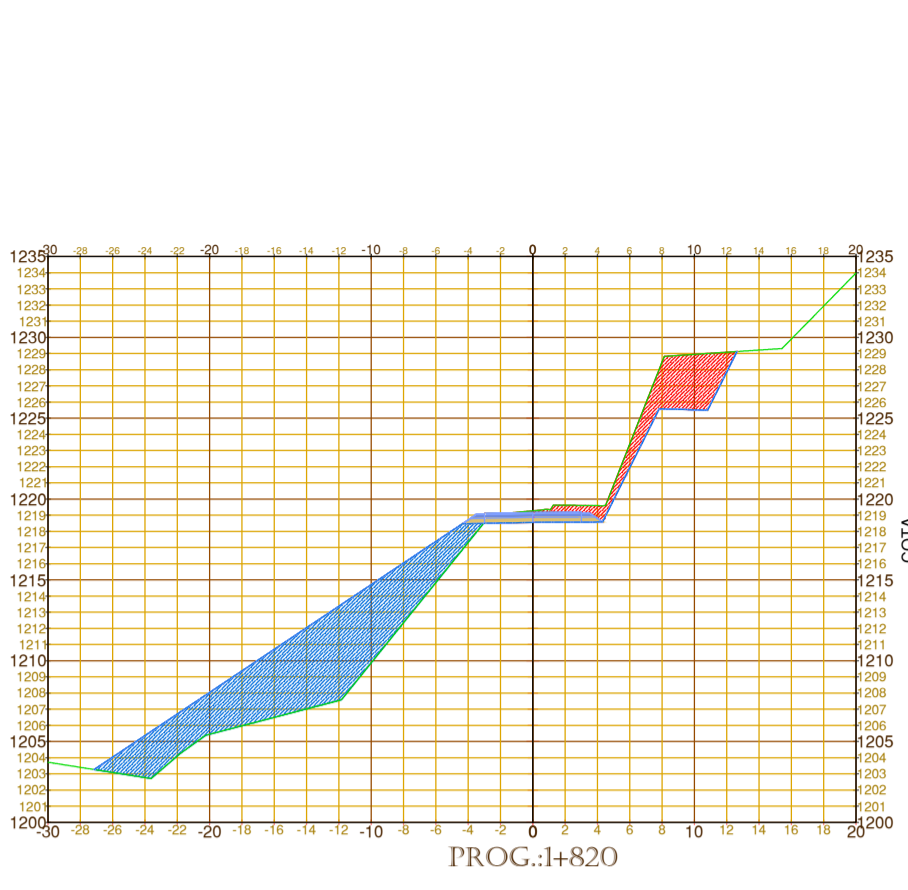
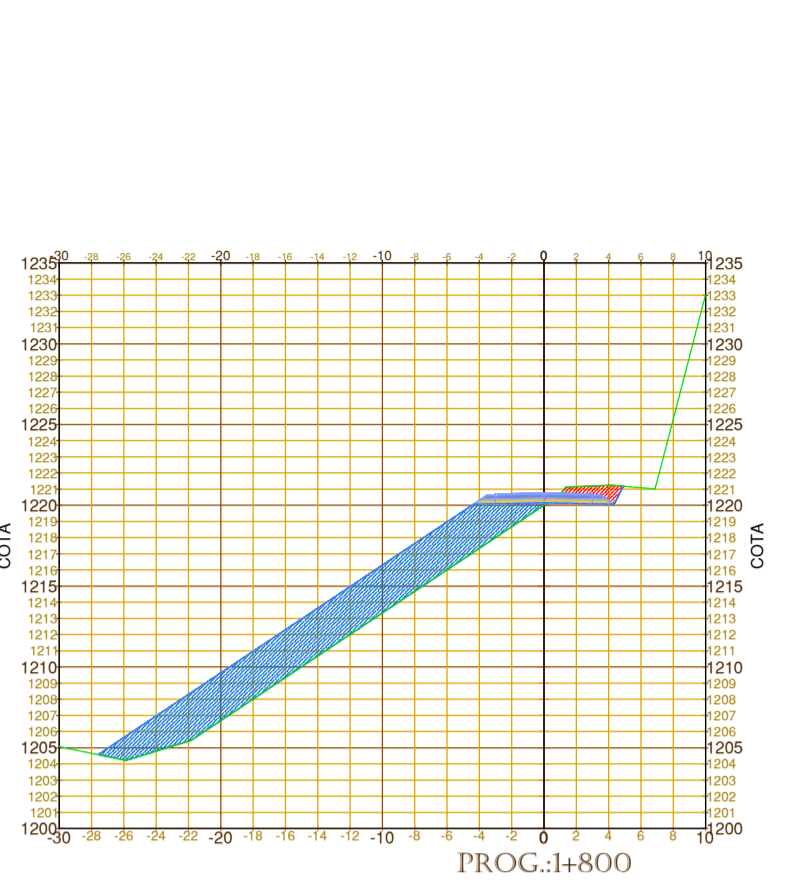
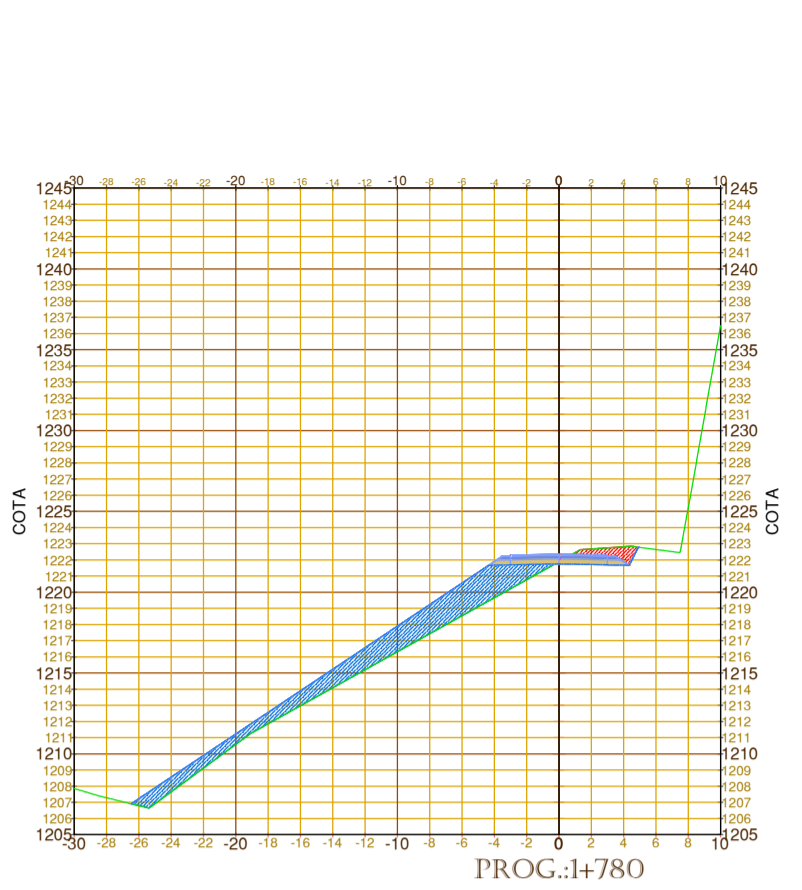
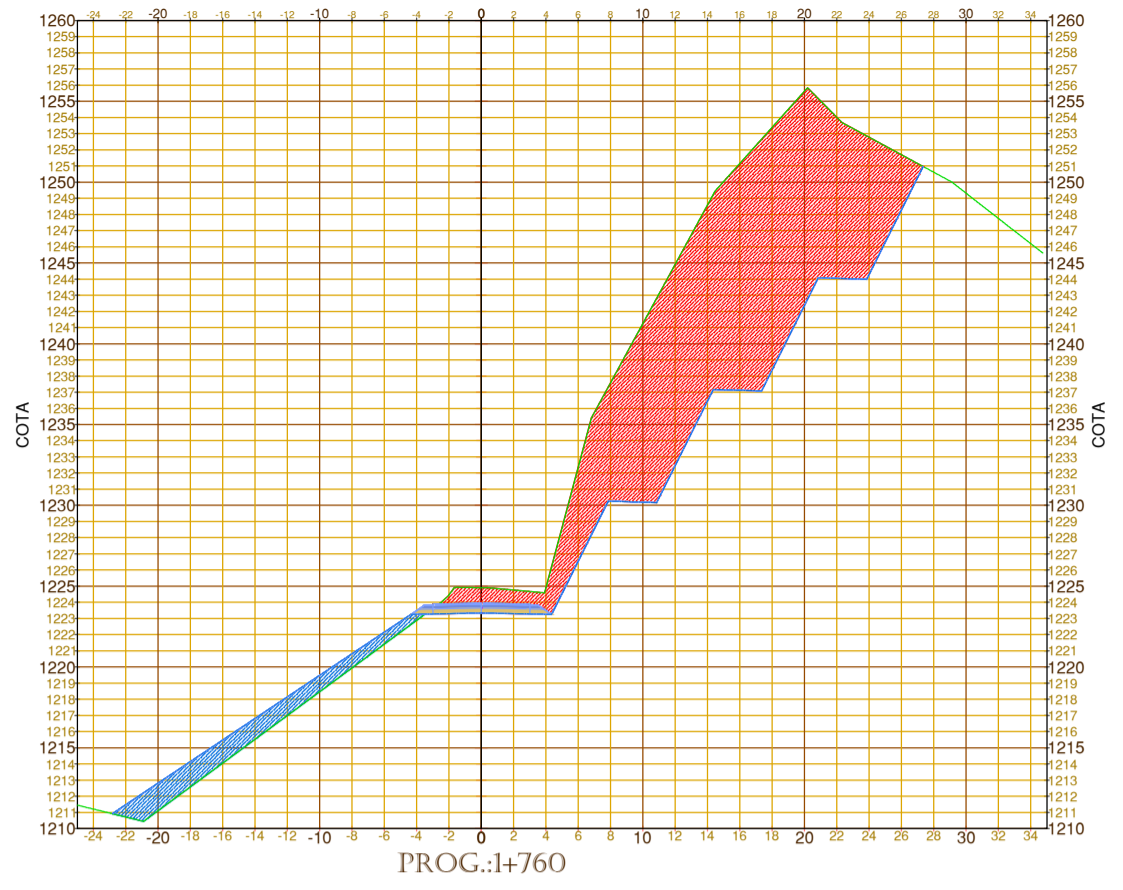
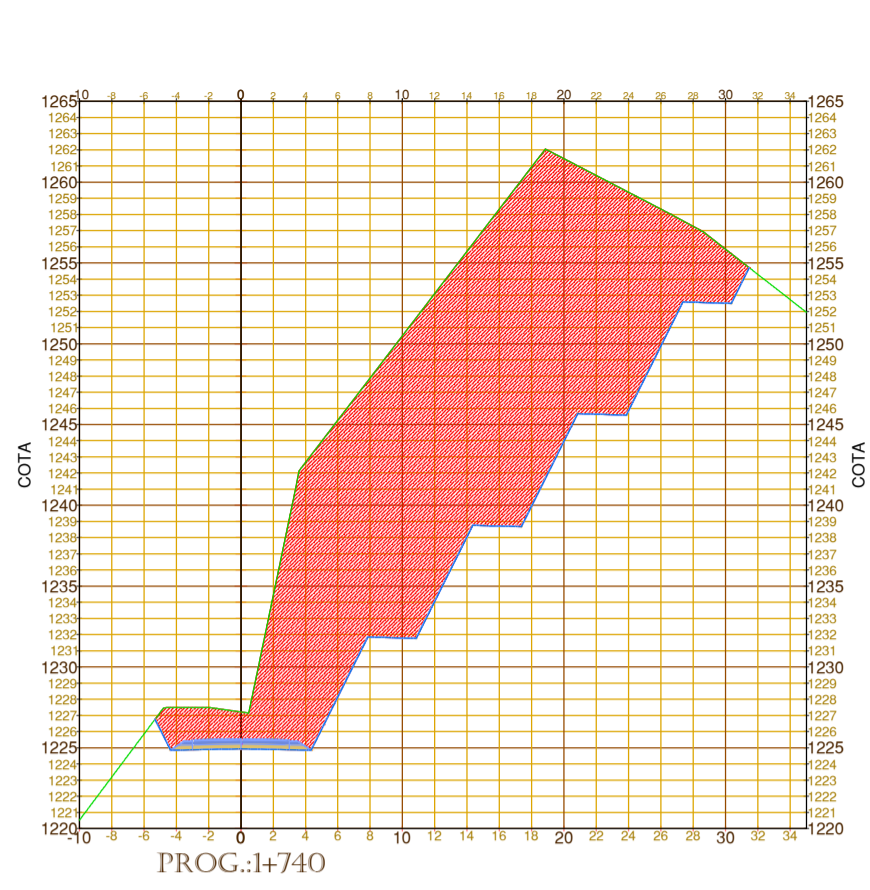

UNIVERSIDAD AUTONOMA JUAN MISAEL SARACHO
FACULTAD DE CIENCIAS Y TECNOLOGÍA
CARRERA: INGENIERÍA CIVIL

PROYECTO:
DISEÑO DE INGENIERÍA DEL TRAMO CRUCE LOS NARANJOS - CRUCE SERERE LIMAL

CARACTER:
PLANO DE SECCIONES TRANSVERSALES

MATERIA:
CIV - 502 PROYECTO DE INGENIERIA CIVIL II

ESTUDIANTE:
MARIO ALBERTO MARTINEZ SALINAS

FECHA:
17 DE SEPTIEMBRE DE 2019

ESCALA:
1:300

N° DE PLANO
5/10

