

PLANTA BAJA  
Esc. 1: 200

VISTAS INTERIORES

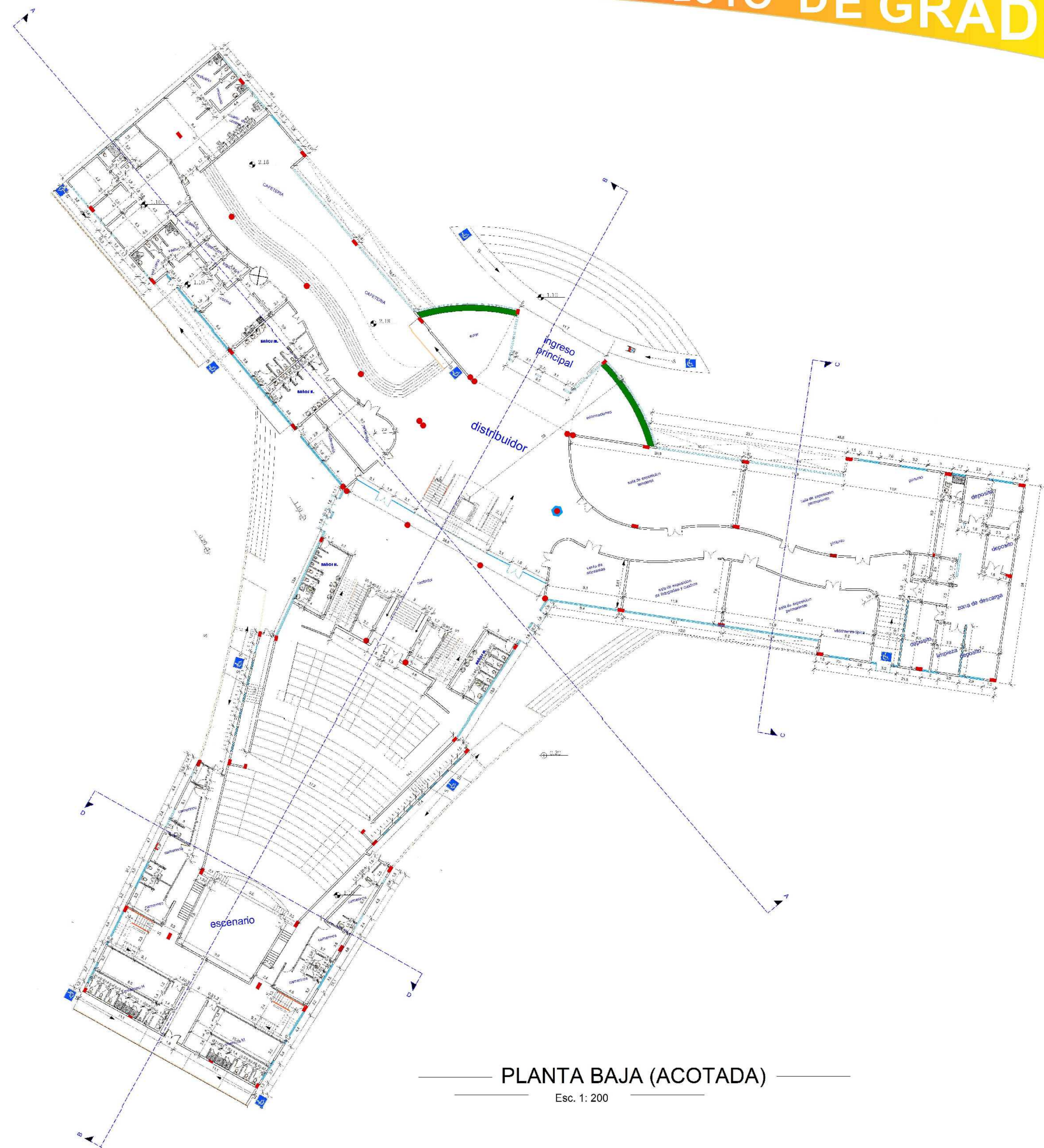

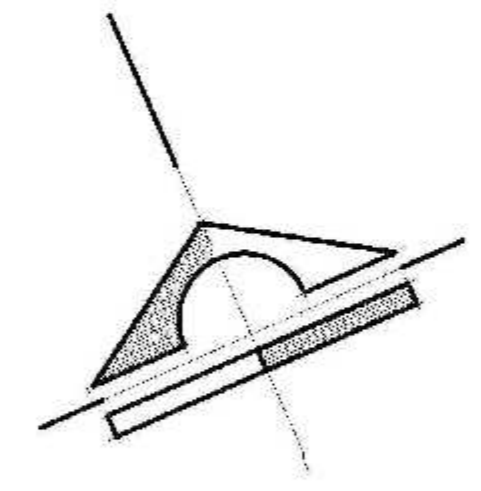
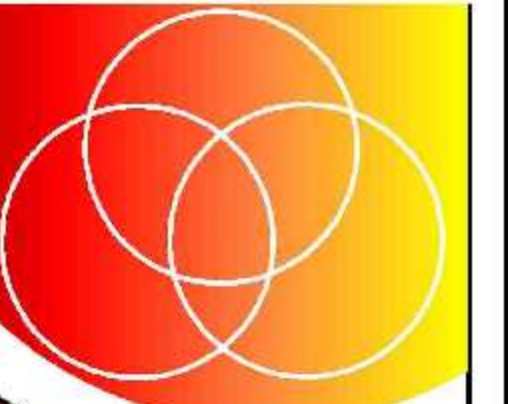

PLANTA BAJA (ACOTADA)

Esc. 1: 200

PROYECTO: MUSEO COSTUMBRISTA DE TARIJA

UNIVERSIDAD AUTONOMA JUAN MISAEL SARACHO

CARRERA: ARQUITECTURA Y URBANISMO FACULTAD: CIENCIAS Y TECNOLOGIA

DOCENTE: Arq. L. JAVIER SANCHEZ M. ESTUDIANTE: WILFREDO PIMENTEL S. GRUPO: 4

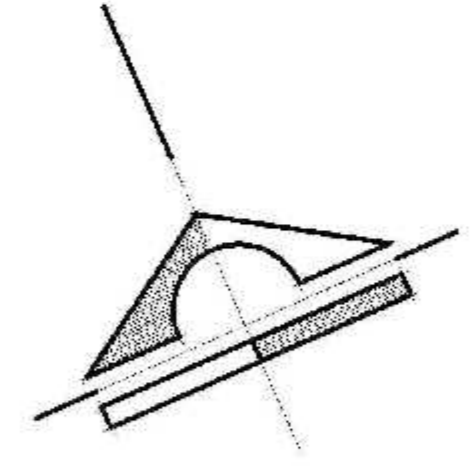
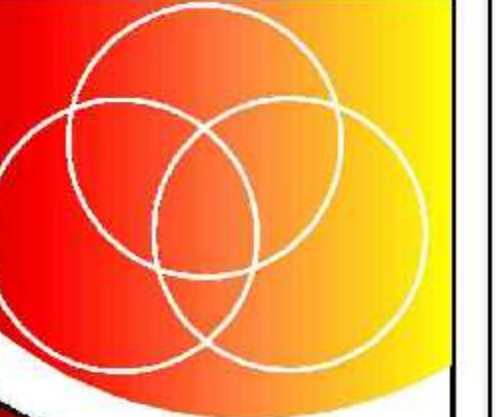

PRIMER PISO

Esc. 1: 200

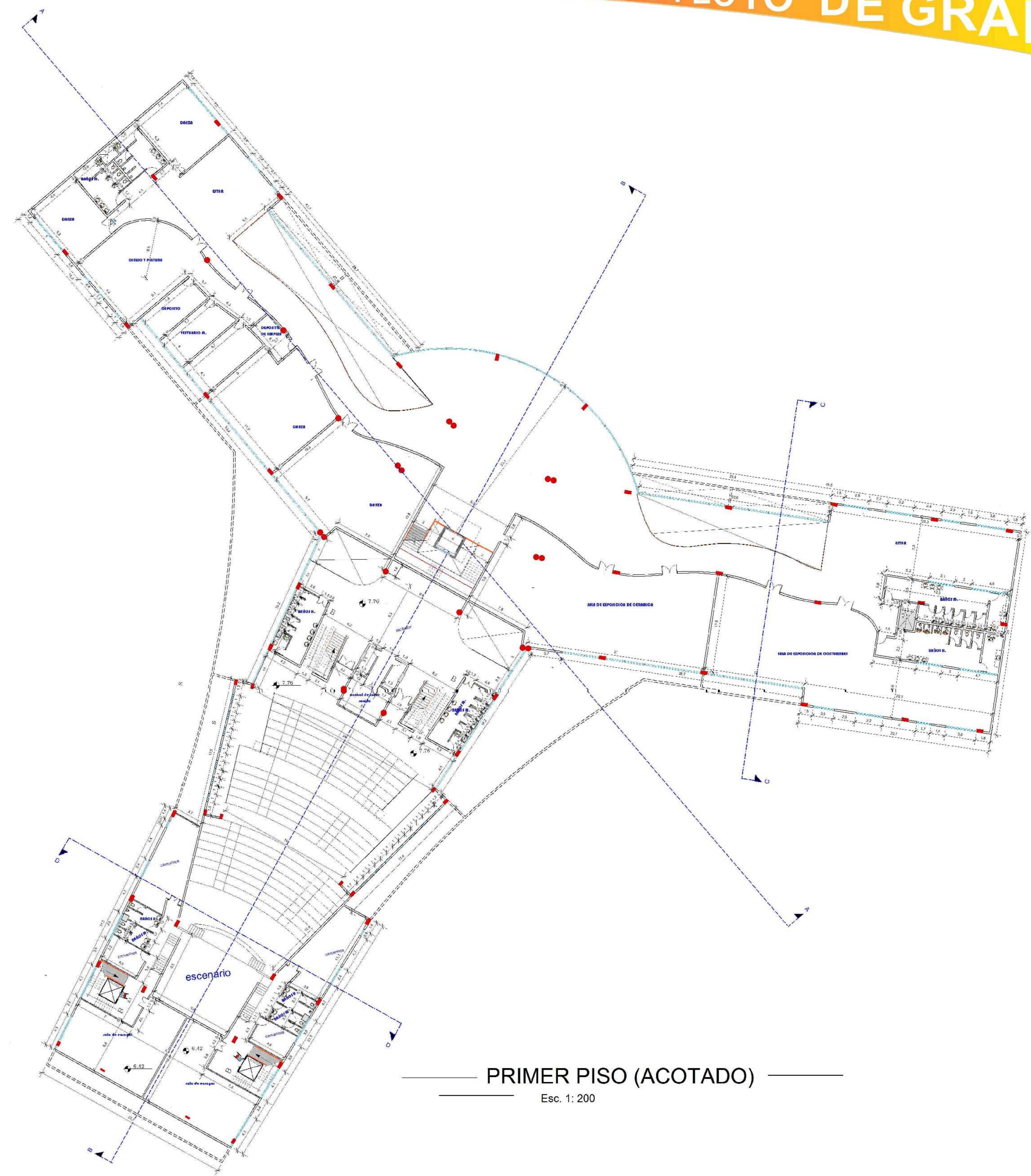
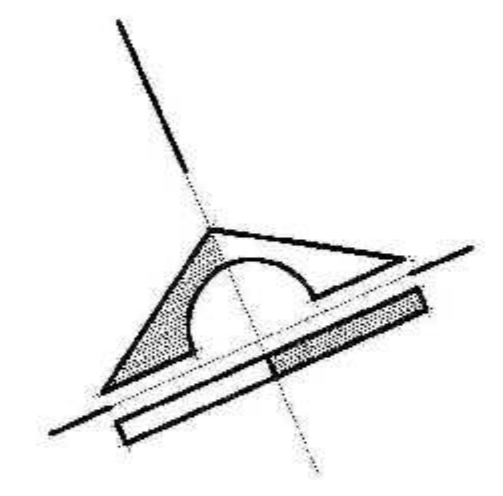

PRIMER PISO (ACOTADO)

Esc. 1: 200

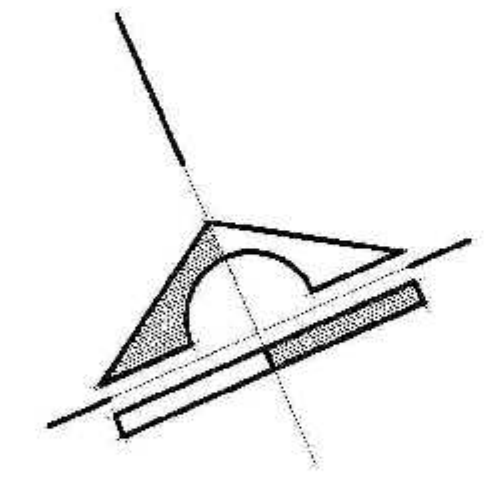

SEGUNDO PISO

Esc. 1:200

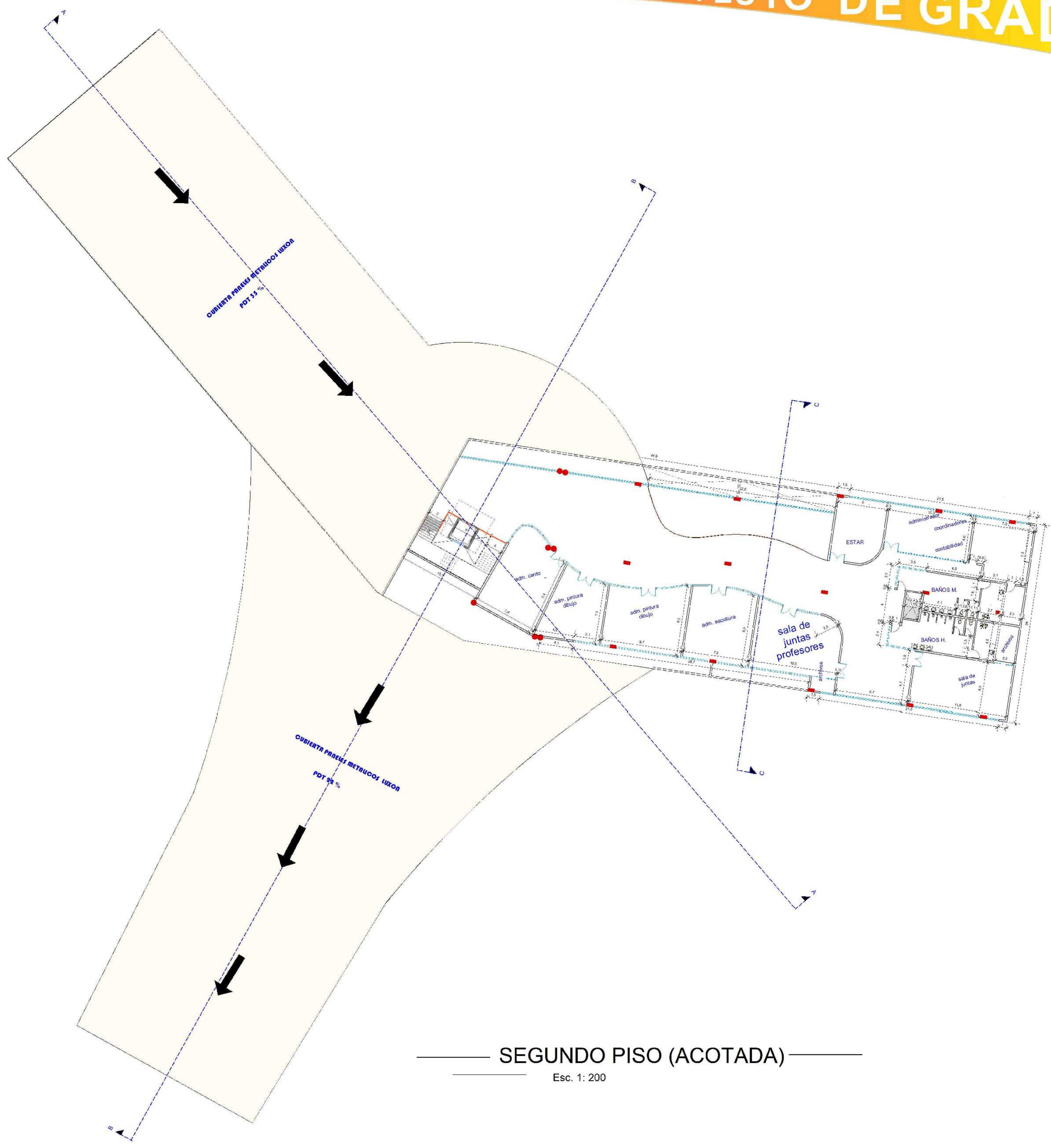
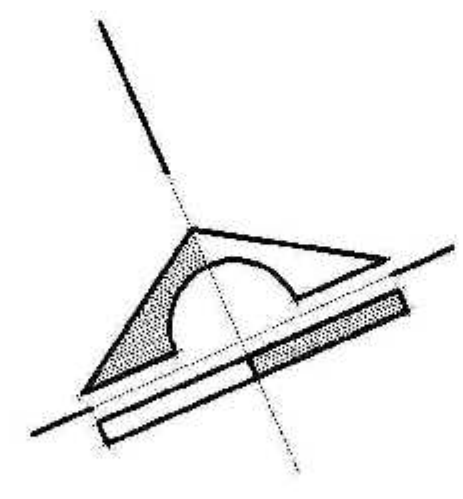

SEGUNDO PISO (ACOTADA)  
Esc. 1: 200

PROYECTO: MUSEO COSTUMBRISTA DE TARIJA

UNIVERSIDAD AUTONOMA JUAN MISAEL SARACHO

CARRERA: ARQUITECTURA Y URBANISMO FACULTAD: CIENCIAS Y TECNOLOGIA

DOCENTE: Arq. L. JAVIER SANCHEZ M. ESTUDIANTE: WILFREDO PIMENTEL S.

GRUPO: 4

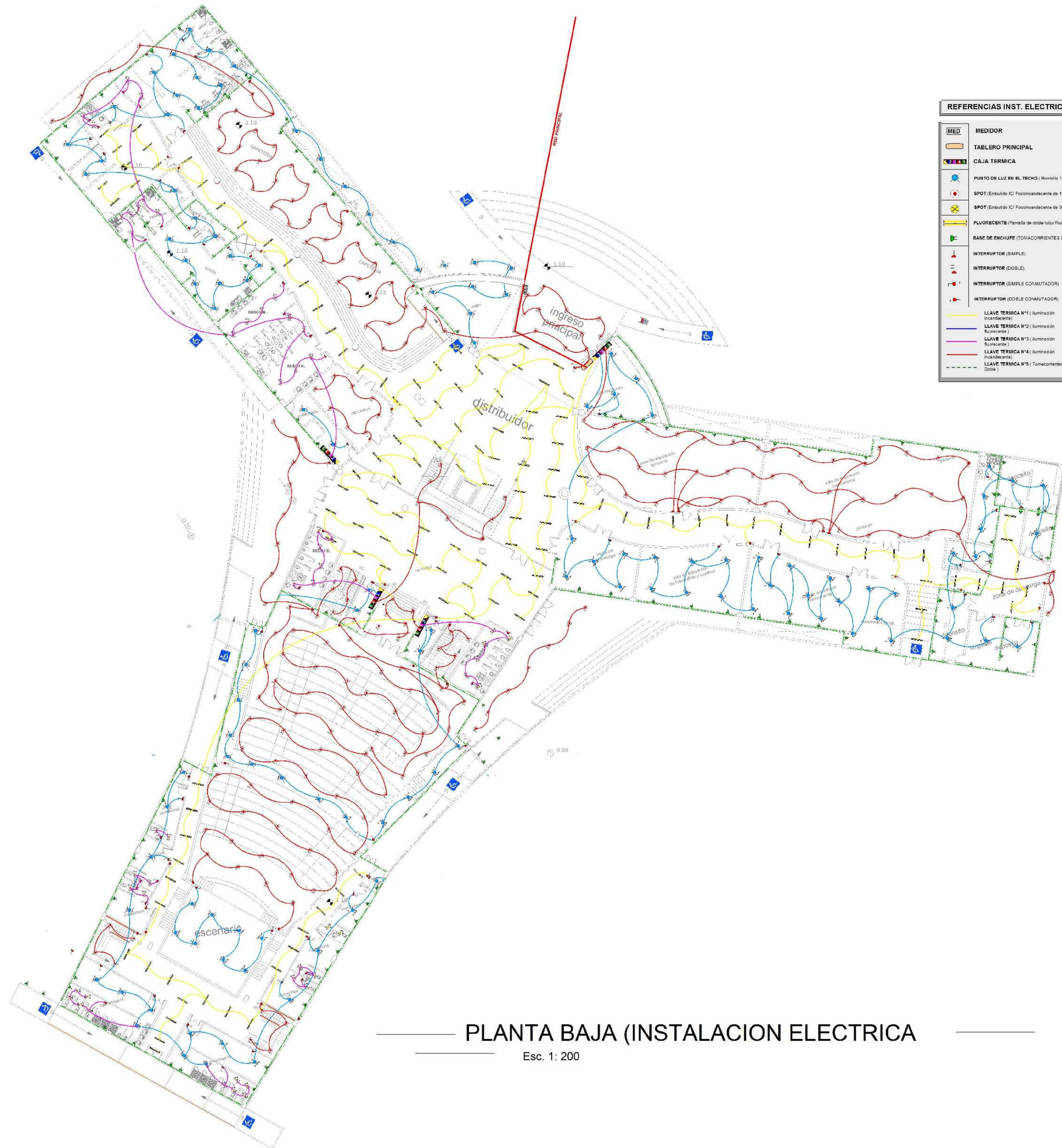
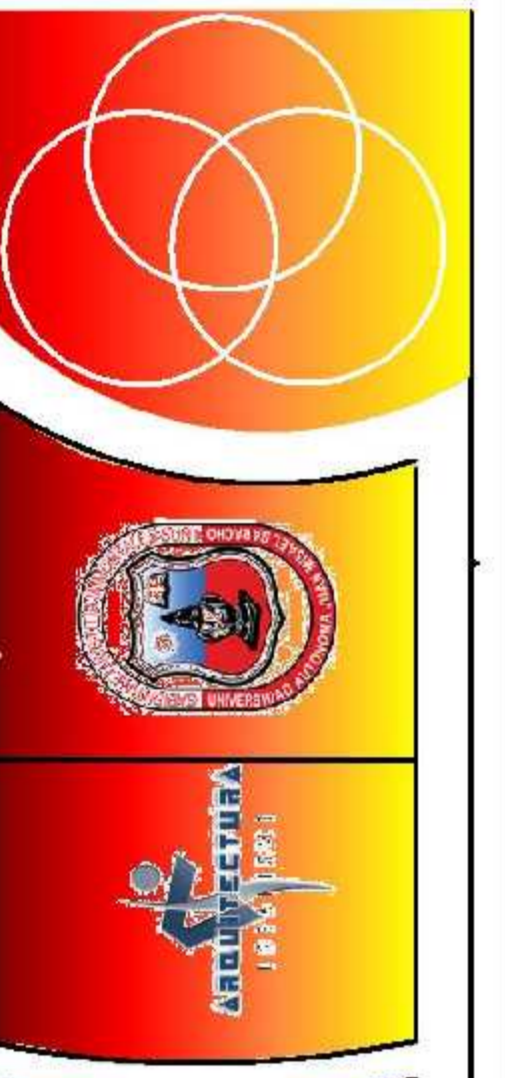

### REFERENCIAS INST. ELECTRICA

(MED)	MEDIDOR
(TAB)	TABLERO PRINCIPAL
(CT)	CAJA TERMICA
(PUNTO DE LUZ EN EL TECHO)	PUNTO DE LUZ EN EL TECHO (Panela 100 x 100)
(SPOT)	SPOT (Embutido IC) Foco incandescente de 100w
(SPOT)	SPOT (Embutido IC) Foco incandescente de 30w
(FLUORESCENTE)	FLUORESCENTE (Panela de doble tubo Fluorescente de 40 W)
(BASE DE ENCHUFE)	BASE DE ENCHUFE (TOMACORRIENTES DOBLE)
(INTERRUPTOR)	INTERRUPTOR (SIMPLE)
(INTERRUPTOR)	INTERRUPTOR (DOBLE)
(INTERRUPTOR)	INTERRUPTOR (SIMPLE COMUTADOR)
(INTERRUPTOR)	INTERRUPTOR (DOBLE COMUTADOR)
(LLAVE TERMICA N°1)	LLAVE TERMICA N°1 (Iluminación Incandescente)
(LLAVE TERMICA N°2)	LLAVE TERMICA N°2 (Iluminación Fluorescente)
(LLAVE TERMICA N°3)	LLAVE TERMICA N°3 (Iluminación Fluorescente)
(LLAVE TERMICA N°4)	LLAVE TERMICA N°4 (Iluminación Incandescente)
(LLAVE TERMICA N°5)	LLAVE TERMICA N°5 (Tomacorrientes Doble)

PLANTA BAJA (INSTALACION ELECTRICA)

Esc. 1: 200



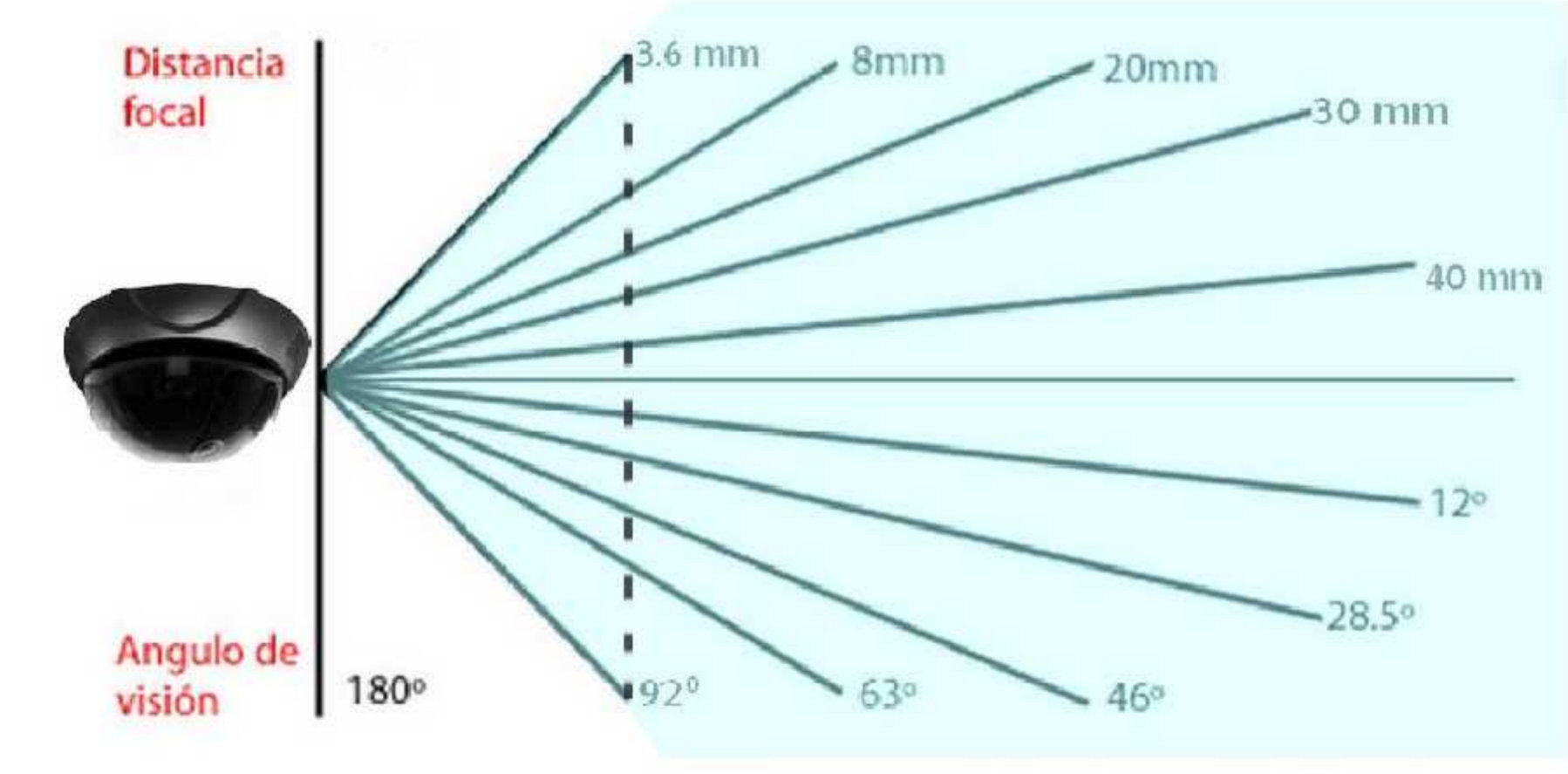
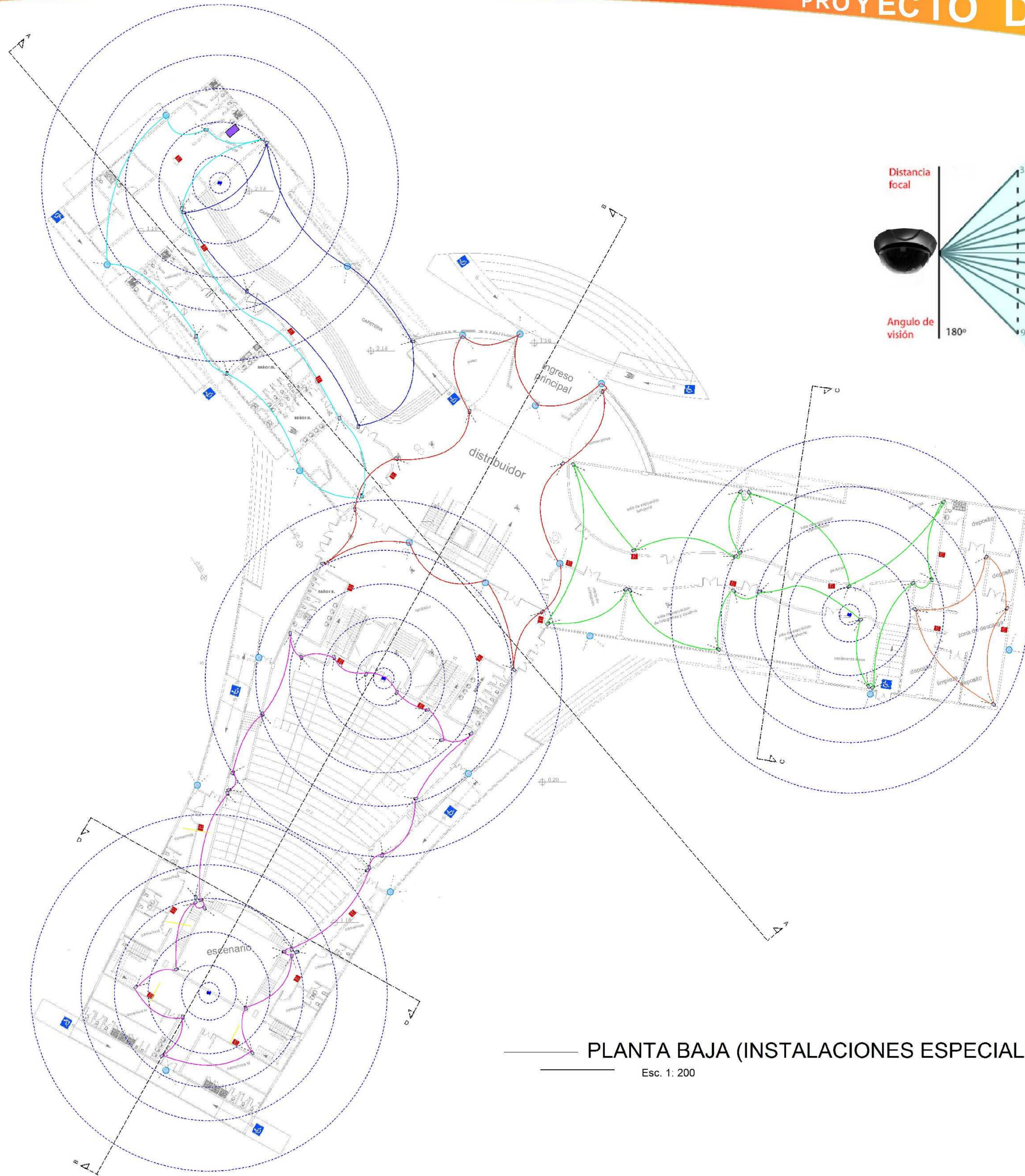
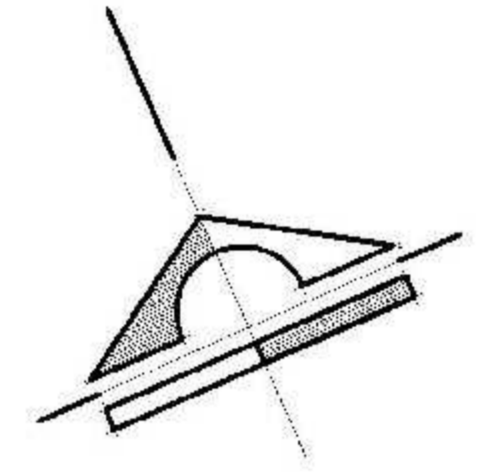

REFERENCIAS INST. CAMARAS	
	TABLERO DE CONTROLES
	CAMARA DE SEGURIDAD
	CAMARA DE SEGURIDAD
	AREA DE CAFETERIA
	AREA CENTRAL
	AREA DE EXPOCIONES
	AREA DE TEATRO
	AREA DE DEPOSITO
	AREA DE COCINA
	AREA DE WIFI
	EXTENTOR

PLANTA BAJA (INSTALACIONES ESPECIALES)  
 Esc. 1: 200

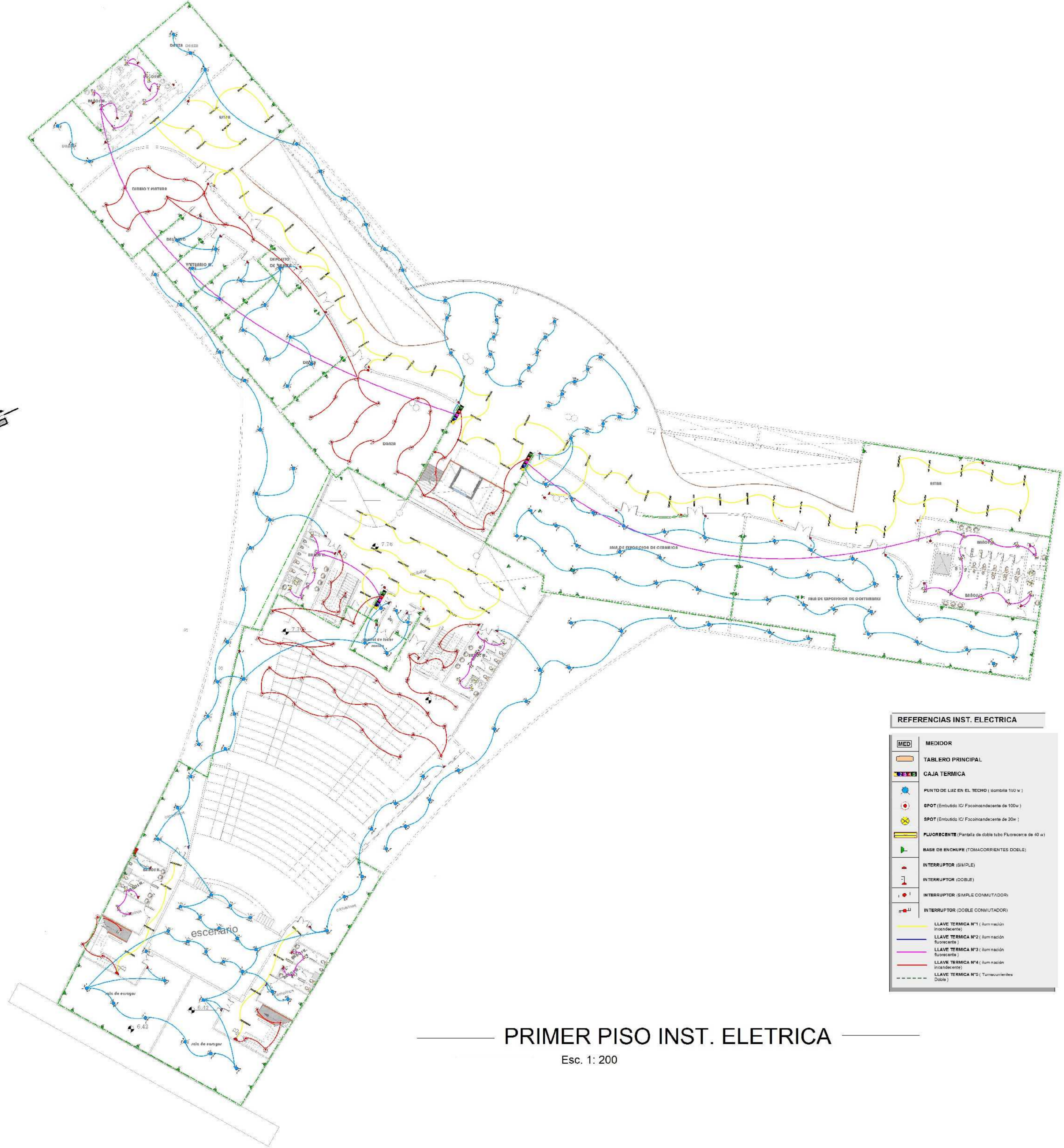
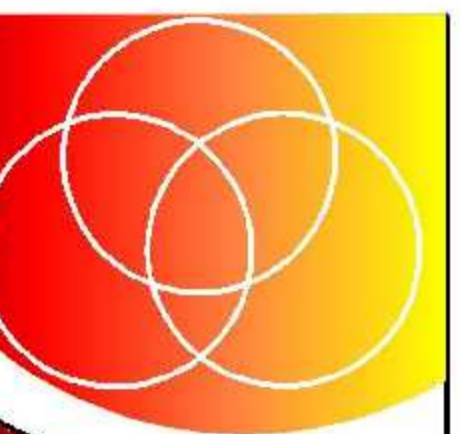

REFERENCIAS INST. ELECTRICA	
MED	MEDIDOR
[Symbol]	TABLERO PRINCIPAL
[Symbol]	CAJA TERMICA
[Symbol]	PUNTO DE LUZ EN EL TECHO (sombra 100 w)
[Symbol]	SPOT (Embutido IC Fluorescente de 100w)
[Symbol]	SPOT (Embutido IC Fluorescente de 30w)
[Symbol]	FLUORESCENTE (Pantalla de doble tubo Fluorescente de 40 w)
[Symbol]	BASE DE ENCHUFE (TOMACORRIENTES DOBLE)
[Symbol]	INTERRUPTOR (SIMPLE)
[Symbol]	INTERRUPTOR (DOBLE)
[Symbol]	INTERRUPTOR (SIMPLE CONMUTADOR)
[Symbol]	INTERRUPTOR (DOBLE CONMUTADOR)
[Symbol]	LLAVE TERMICA N°1 (sumacion fluorescente)
[Symbol]	LLAVE TERMICA N°2 (sumacion fluorescente)
[Symbol]	LLAVE TERMICA N°3 (sumacion fluorescente)
[Symbol]	LLAVE TERMICA N°4 (sumacion fluorescente)
[Symbol]	LLAVE TERMICA N°5 (sumacion fluorescente)
[Symbol]	LLAVE TERMICA N°6 (sumacion fluorescente)
[Symbol]	LLAVE TERMICA N°7 (sumacion fluorescente)
[Symbol]	LLAVE TERMICA N°8 (sumacion fluorescente)
[Symbol]	LLAVE TERMICA N°9 (sumacion fluorescente)
[Symbol]	LLAVE TERMICA N°10 (sumacion fluorescente)
[Symbol]	LLAVE TERMICA N°11 (sumacion fluorescente)
[Symbol]	LLAVE TERMICA N°12 (sumacion fluorescente)
[Symbol]	LLAVE TERMICA N°13 (sumacion fluorescente)
[Symbol]	LLAVE TERMICA N°14 (sumacion fluorescente)
[Symbol]	LLAVE TERMICA N°15 (sumacion fluorescente)
[Symbol]	LLAVE TERMICA N°16 (sumacion fluorescente)
[Symbol]	LLAVE TERMICA N°17 (sumacion fluorescente)
[Symbol]	LLAVE TERMICA N°18 (sumacion fluorescente)
[Symbol]	LLAVE TERMICA N°19 (sumacion fluorescente)
[Symbol]	LLAVE TERMICA N°20 (sumacion fluorescente)
[Symbol]	LLAVE TERMICA N°21 (sumacion fluorescente)
[Symbol]	LLAVE TERMICA N°22 (sumacion fluorescente)
[Symbol]	LLAVE TERMICA N°23 (sumacion fluorescente)
[Symbol]	LLAVE TERMICA N°24 (sumacion fluorescente)
[Symbol]	LLAVE TERMICA N°25 (sumacion fluorescente)
[Symbol]	LLAVE TERMICA N°26 (sumacion fluorescente)
[Symbol]	LLAVE TERMICA N°27 (sumacion fluorescente)
[Symbol]	LLAVE TERMICA N°28 (sumacion fluorescente)
[Symbol]	LLAVE TERMICA N°29 (sumacion fluorescente)
[Symbol]	LLAVE TERMICA N°30 (sumacion fluorescente)
[Symbol]	LLAVE TERMICA N°31 (sumacion fluorescente)
[Symbol]	LLAVE TERMICA N°32 (sumacion fluorescente)
[Symbol]	LLAVE TERMICA N°33 (sumacion fluorescente)
[Symbol]	LLAVE TERMICA N°34 (sumacion fluorescente)
[Symbol]	LLAVE TERMICA N°35 (sumacion fluorescente)
[Symbol]	LLAVE TERMICA N°36 (sumacion fluorescente)
[Symbol]	LLAVE TERMICA N°37 (sumacion fluorescente)
[Symbol]	LLAVE TERMICA N°38 (sumacion fluorescente)
[Symbol]	LLAVE TERMICA N°39 (sumacion fluorescente)
[Symbol]	LLAVE TERMICA N°40 (sumacion fluorescente)
[Symbol]	LLAVE TERMICA N°41 (sumacion fluorescente)
[Symbol]	LLAVE TERMICA N°42 (sumacion fluorescente)
[Symbol]	LLAVE TERMICA N°43 (sumacion fluorescente)
[Symbol]	LLAVE TERMICA N°44 (sumacion fluorescente)
[Symbol]	LLAVE TERMICA N°45 (sumacion fluorescente)
[Symbol]	LLAVE TERMICA N°46 (sumacion fluorescente)
[Symbol]	LLAVE TERMICA N°47 (sumacion fluorescente)
[Symbol]	LLAVE TERMICA N°48 (sumacion fluorescente)
[Symbol]	LLAVE TERMICA N°49 (sumacion fluorescente)
[Symbol]	LLAVE TERMICA N°50 (sumacion fluorescente)
[Symbol]	LLAVE TERMICA N°51 (sumacion fluorescente)
[Symbol]	LLAVE TERMICA N°52 (sumacion fluorescente)
[Symbol]	LLAVE TERMICA N°53 (sumacion fluorescente)
[Symbol]	LLAVE TERMICA N°54 (sumacion fluorescente)
[Symbol]	LLAVE TERMICA N°55 (sumacion fluorescente)
[Symbol]	LLAVE TERMICA N°56 (sumacion fluorescente)
[Symbol]	LLAVE TERMICA N°57 (sumacion fluorescente)
[Symbol]	LLAVE TERMICA N°58 (sumacion fluorescente)
[Symbol]	LLAVE TERMICA N°59 (sumacion fluorescente)
[Symbol]	LLAVE TERMICA N°60 (sumacion fluorescente)
[Symbol]	LLAVE TERMICA N°61 (sumacion fluorescente)
[Symbol]	LLAVE TERMICA N°62 (sumacion fluorescente)
[Symbol]	LLAVE TERMICA N°63 (sumacion fluorescente)
[Symbol]	LLAVE TERMICA N°64 (sumacion fluorescente)
[Symbol]	LLAVE TERMICA N°65 (sumacion fluorescente)
[Symbol]	LLAVE TERMICA N°66 (sumacion fluorescente)
[Symbol]	LLAVE TERMICA N°67 (sumacion fluorescente)
[Symbol]	LLAVE TERMICA N°68 (sumacion fluorescente)
[Symbol]	LLAVE TERMICA N°69 (sumacion fluorescente)
[Symbol]	LLAVE TERMICA N°70 (sumacion fluorescente)
[Symbol]	LLAVE TERMICA N°71 (sumacion fluorescente)
[Symbol]	LLAVE TERMICA N°72 (sumacion fluorescente)
[Symbol]	LLAVE TERMICA N°73 (sumacion fluorescente)
[Symbol]	LLAVE TERMICA N°74 (sumacion fluorescente)
[Symbol]	LLAVE TERMICA N°75 (sumacion fluorescente)
[Symbol]	LLAVE TERMICA N°76 (sumacion fluorescente)
[Symbol]	LLAVE TERMICA N°77 (sumacion fluorescente)
[Symbol]	LLAVE TERMICA N°78 (sumacion fluorescente)
[Symbol]	LLAVE TERMICA N°79 (sumacion fluorescente)
[Symbol]	LLAVE TERMICA N°80 (sumacion fluorescente)
[Symbol]	LLAVE TERMICA N°81 (sumacion fluorescente)
[Symbol]	LLAVE TERMICA N°82 (sumacion fluorescente)
[Symbol]	LLAVE TERMICA N°83 (sumacion fluorescente)
[Symbol]	LLAVE TERMICA N°84 (sumacion fluorescente)
[Symbol]	LLAVE TERMICA N°85 (sumacion fluorescente)
[Symbol]	LLAVE TERMICA N°86 (sumacion fluorescente)
[Symbol]	LLAVE TERMICA N°87 (sumacion fluorescente)
[Symbol]	LLAVE TERMICA N°88 (sumacion fluorescente)
[Symbol]	LLAVE TERMICA N°89 (sumacion fluorescente)
[Symbol]	LLAVE TERMICA N°90 (sumacion fluorescente)
[Symbol]	LLAVE TERMICA N°91 (sumacion fluorescente)
[Symbol]	LLAVE TERMICA N°92 (sumacion fluorescente)
[Symbol]	LLAVE TERMICA N°93 (sumacion fluorescente)
[Symbol]	LLAVE TERMICA N°94 (sumacion fluorescente)
[Symbol]	LLAVE TERMICA N°95 (sumacion fluorescente)
[Symbol]	LLAVE TERMICA N°96 (sumacion fluorescente)
[Symbol]	LLAVE TERMICA N°97 (sumacion fluorescente)
[Symbol]	LLAVE TERMICA N°98 (sumacion fluorescente)
[Symbol]	LLAVE TERMICA N°99 (sumacion fluorescente)
[Symbol]	LLAVE TERMICA N°100 (sumacion fluorescente)

PRIMER PISO INST. ELETRICA

Esc. 1: 200

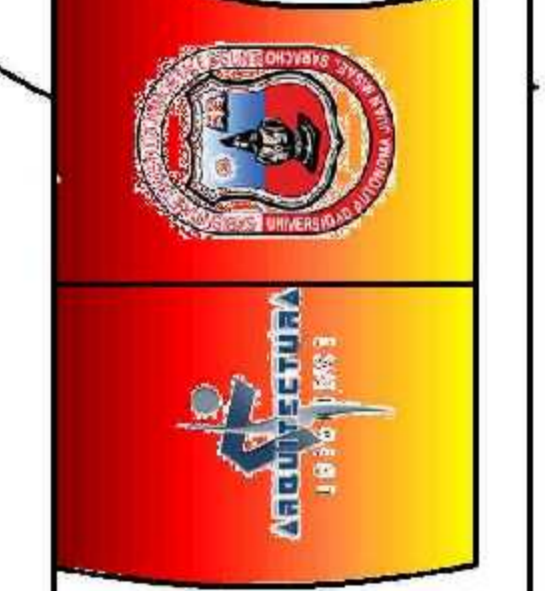
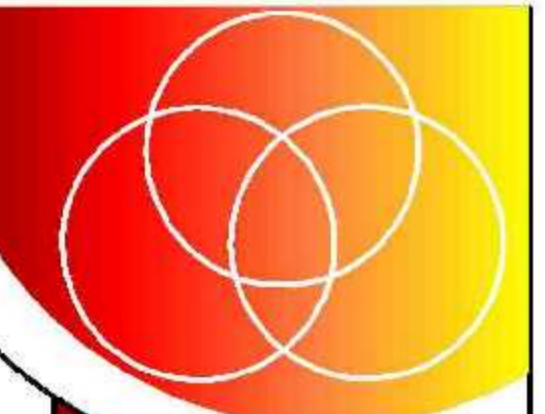

UNIVERSIDAD AUTONOMA JUAN MISAEL SARACHO  
CARRERA: ARQUITECTURA Y URBANISMO FACULTAD: CIENCIAS Y TECNOLOGIA

PROYECTO: MUSEO COSTUMBRISTA DE TARIJA  
DOCENTE: Arq. L. JAVIER SANCHEZ M. ESTUDIANTE: WILFREDO PIMENTEL S. GRUPO: 4

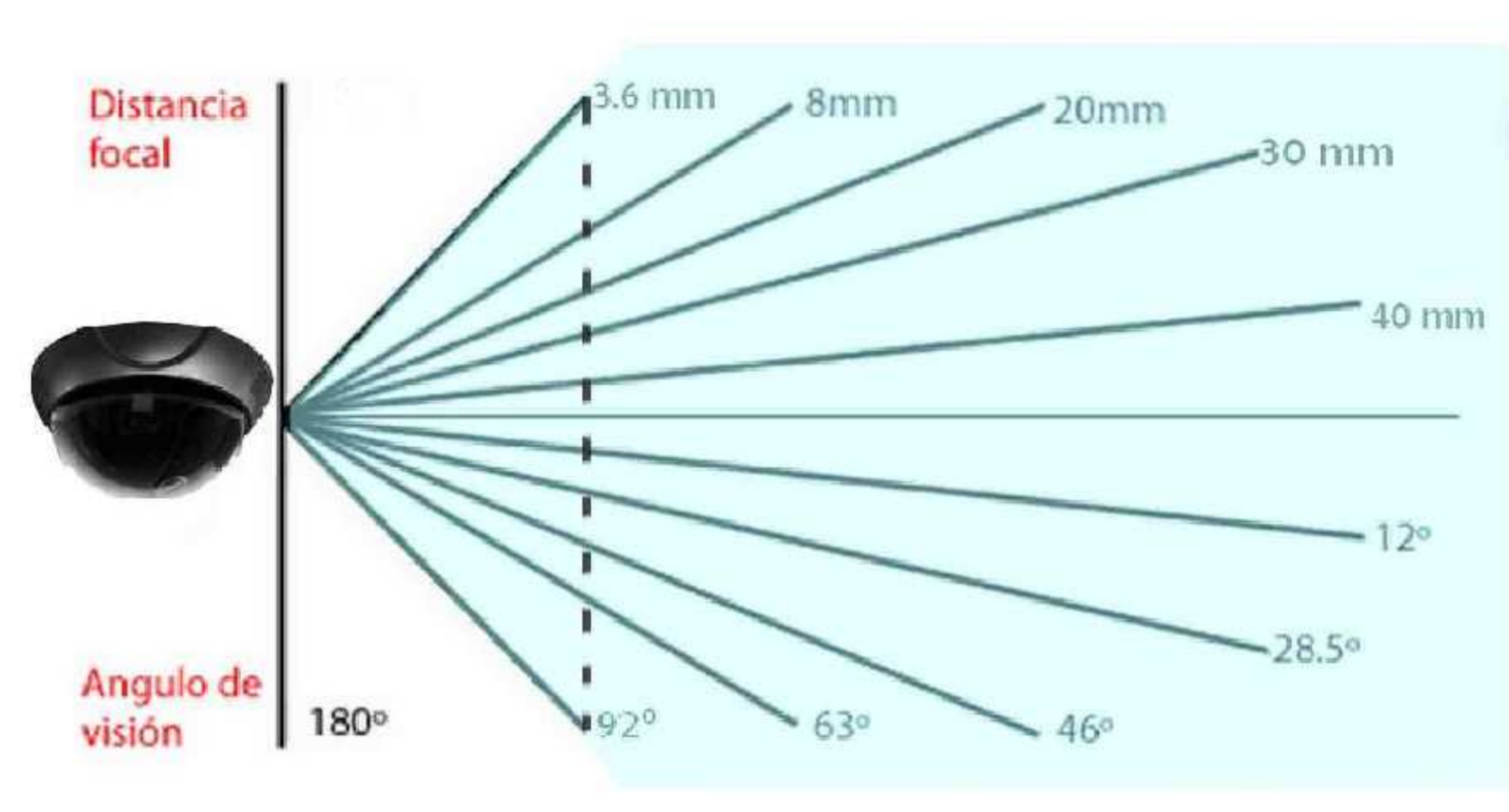
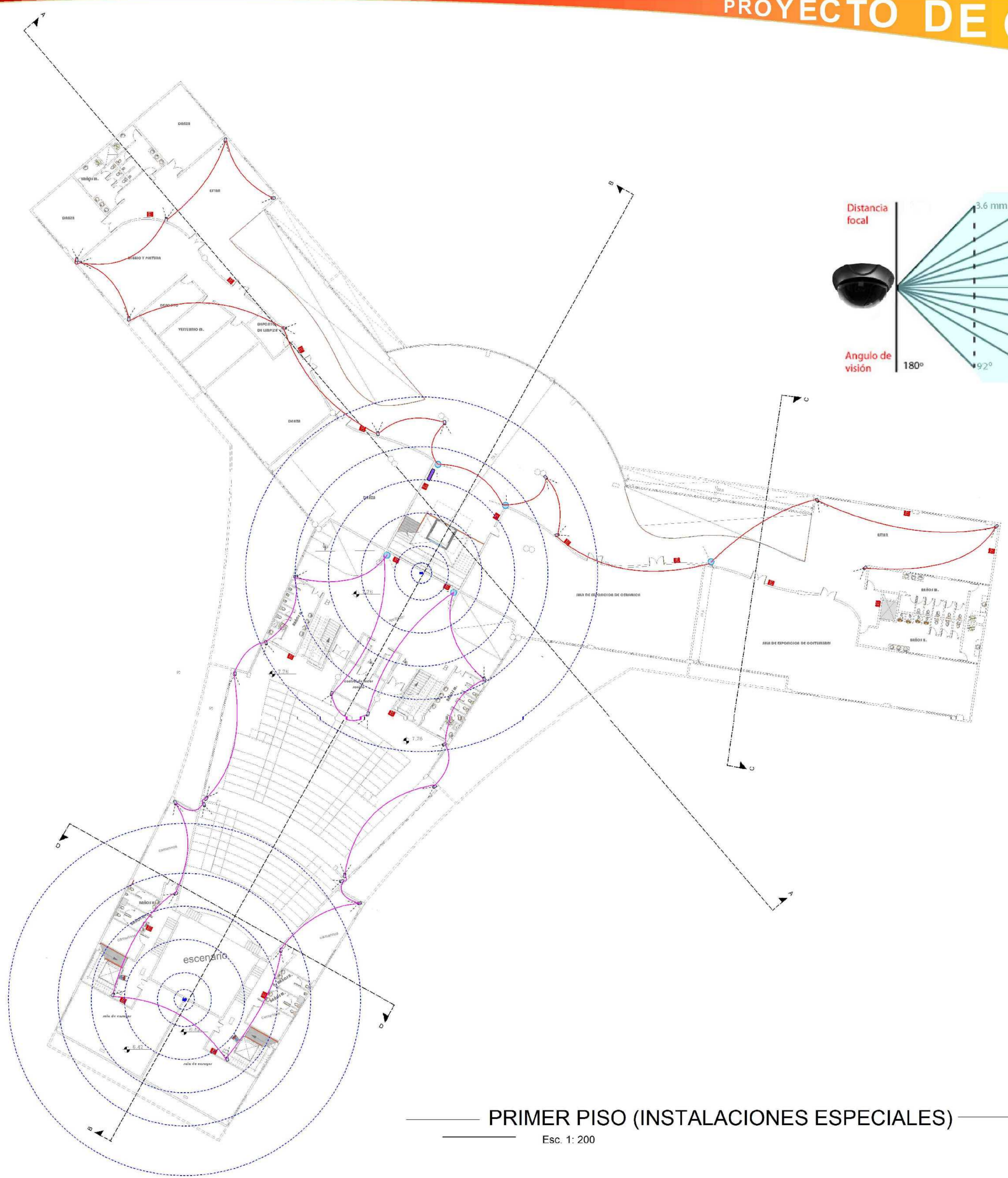
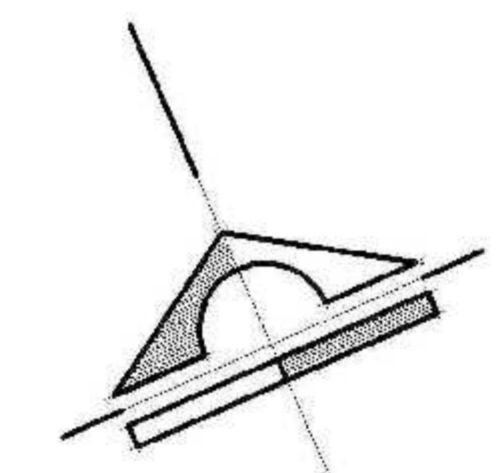

REFERENCIAS INST. CAMARAS	
	TABLERO DE CONTROLES
	CAMARA DE SEGURIDAD
	CAMARA DE SEGURIDAD
	AREA CENTRAL
	AREA DE TEATRO
	AREA DE WIFI
	EXTENTOR

PRIMER PISO (INSTALACIONES ESPECIALES)

Esc. 1: 200