

UNIVERSITARIO: BLADIMIR J. MARTINEZ MALLON

DOCENTE: MARCELO H. PACHECO NUÑES

UNIVERSIDAD AUTONOMA JUAN MISAEL SARACHO
 FACULTAD DE CIENCIAS Y TECNOLOGIA
 CARRERA DE INGENIERIA CIVIL
 ASIGNATURA: PROYECTO DE INGENIERIA CIVIL II CIV-502



Proyecto:

DISEÑO DE INGENIERIA TRAMO CARLAZO CENTRO - CARLAZO ESTE

Revisión:

Título: SECCIONES TRANSVERSALES

Escalas: 1:500
 Progresivas: De: 0+000 A: 1+250
 N° de Lámina: 01/09

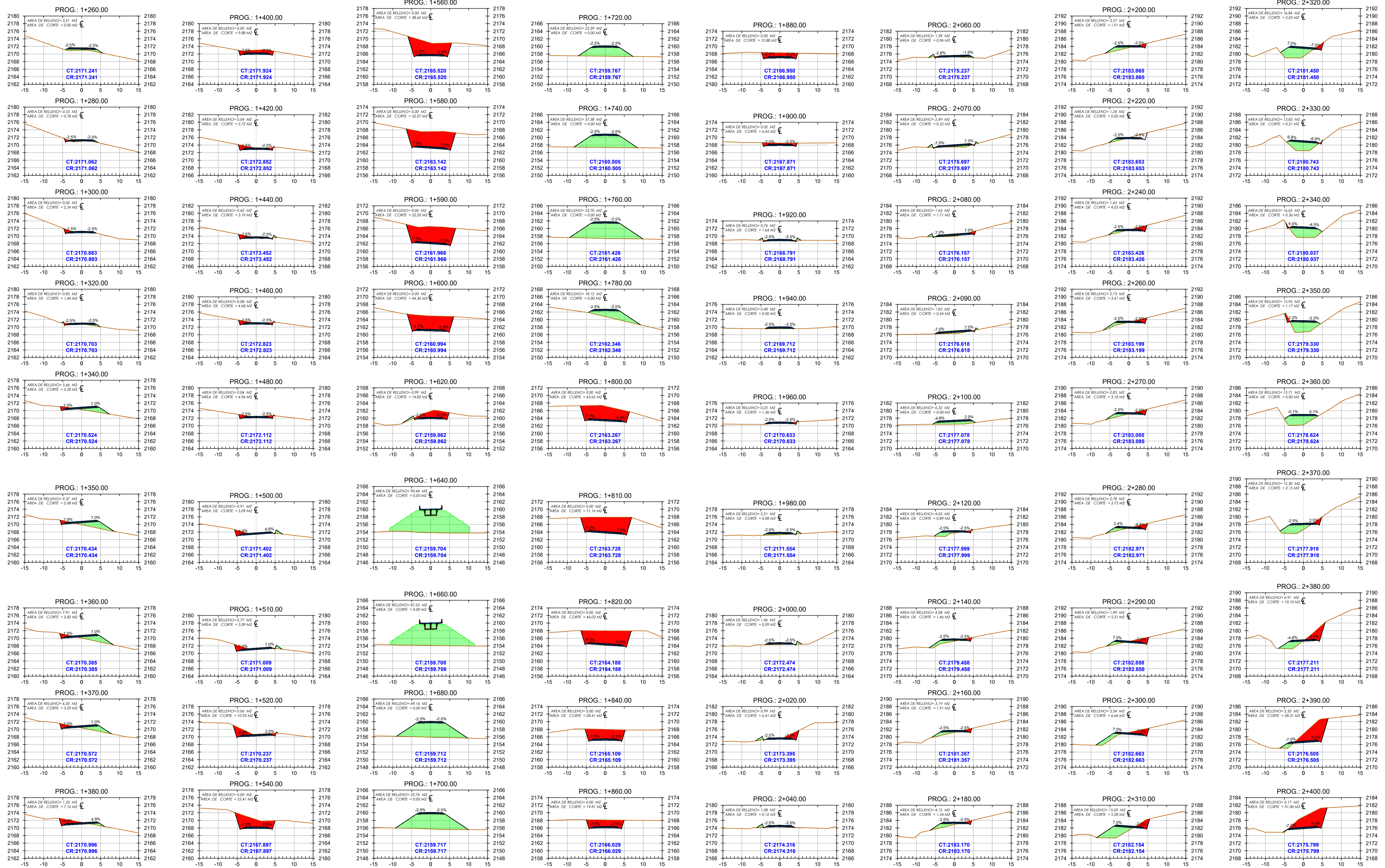

UNIVERSITARIO: BLADIMIR J. MARTINEZ MALLON

DOCENTE: MARCELO H. PACHECO NUÑES

UNIVERSIDAD AUTONOMA JUAN MISAEL SARACHO
 FACULTAD DE CIENCIAS Y TECNOLOGIA
 CARRERA DE INGENIERIA CIVIL
 ASIGNATURA: PROYECTO DE INGENIERIA CIVIL II CIV-502



Proyecto:

DISEÑO DE INGENIERIA TRAMO CARLAZO CENTRO - CARLAZO ESTE

Revisión:

Título: SECCIONES TRANSVERSALES

Escalas: 1:500

Progresivas:
 De: 1+260
 A: 2+400

Nº de Lámina:
 02/09

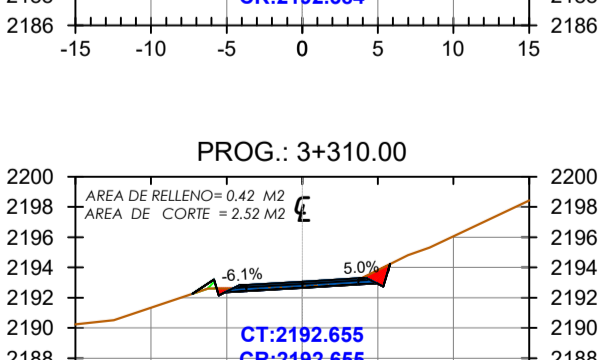
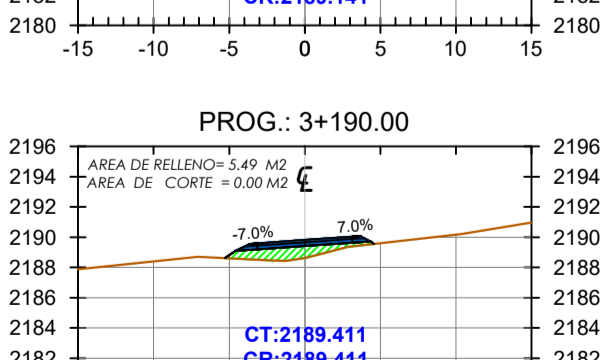
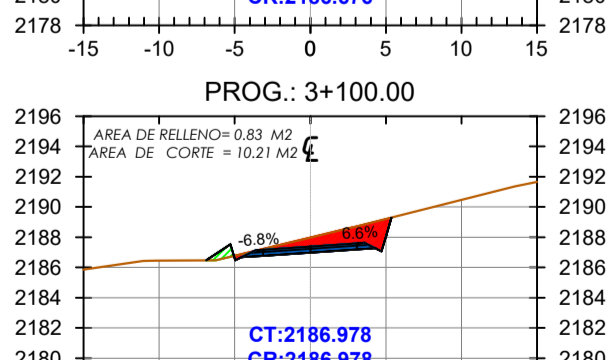
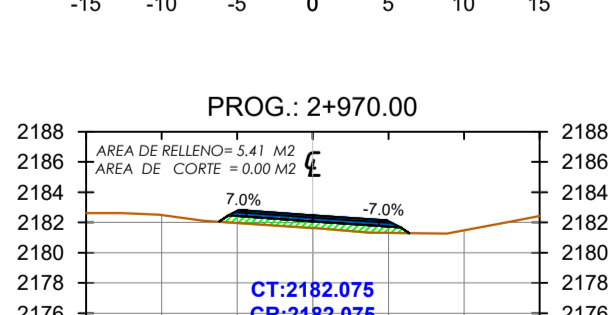
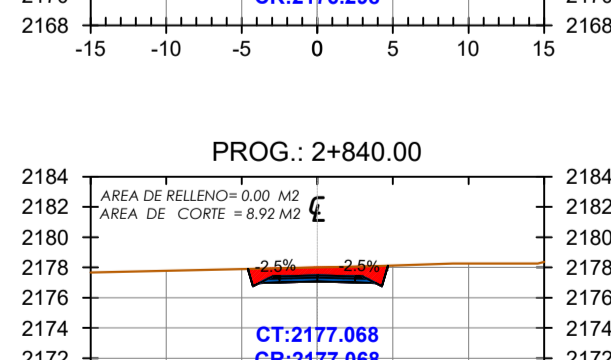
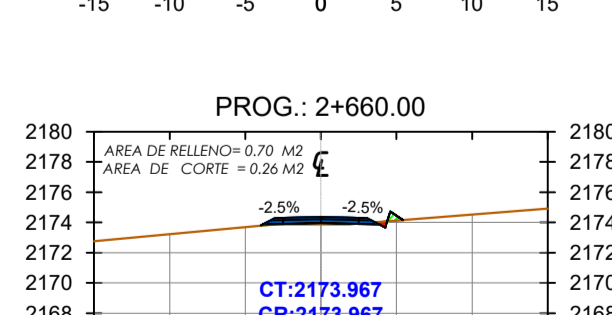
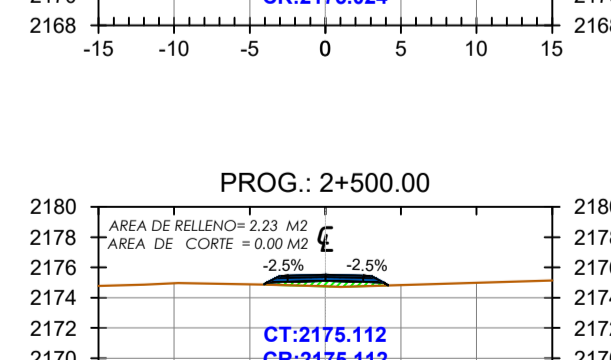
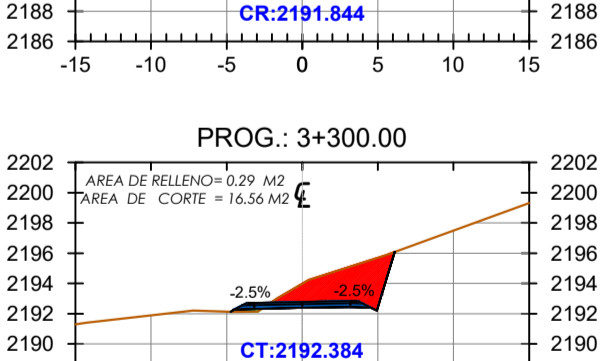
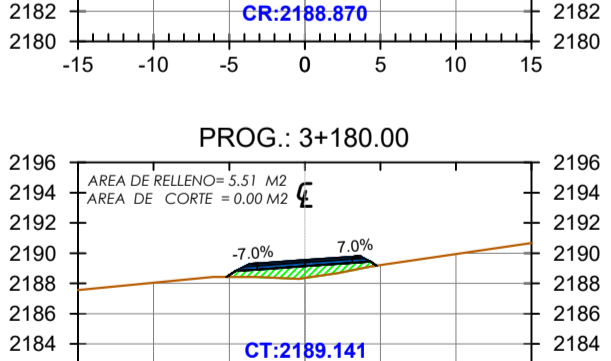
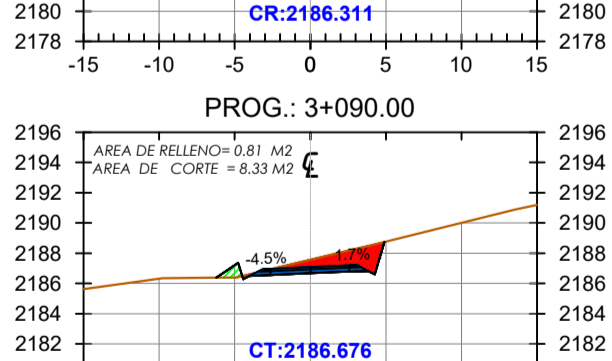
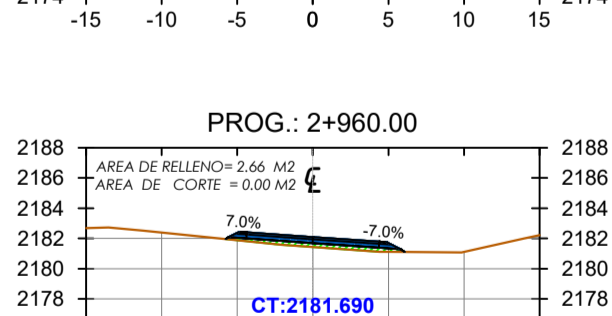
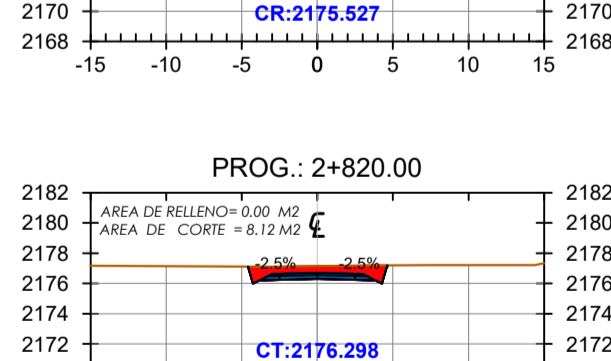
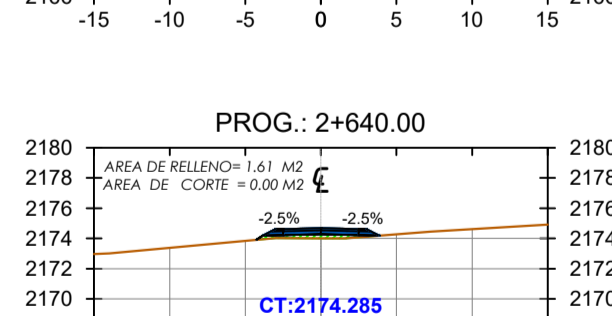
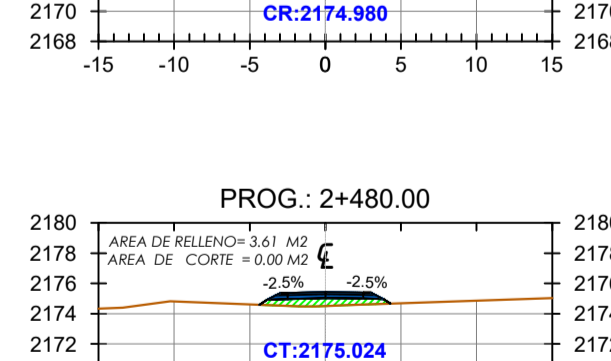
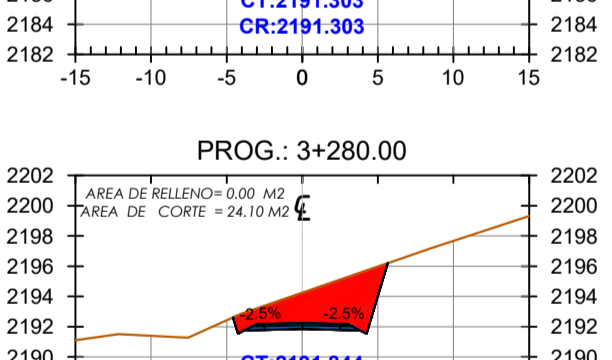
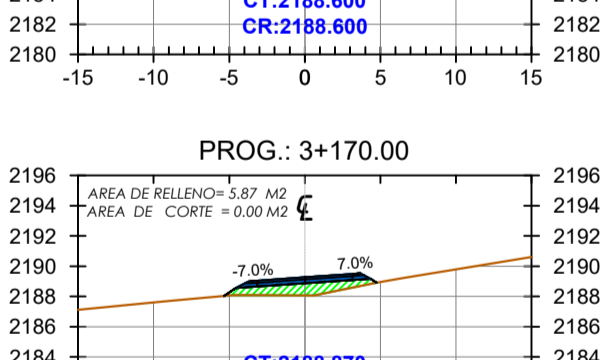
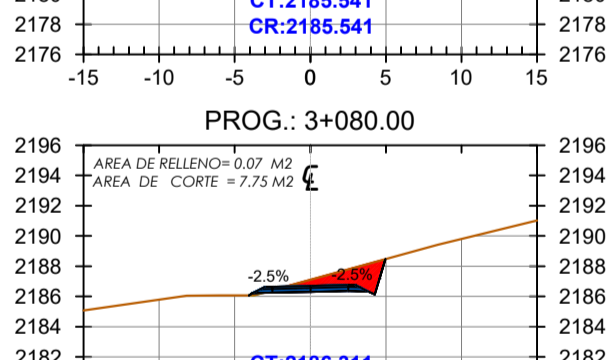
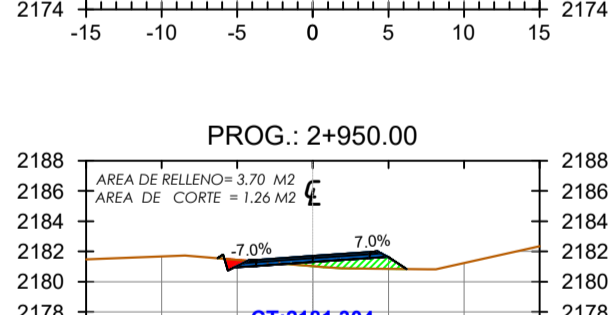
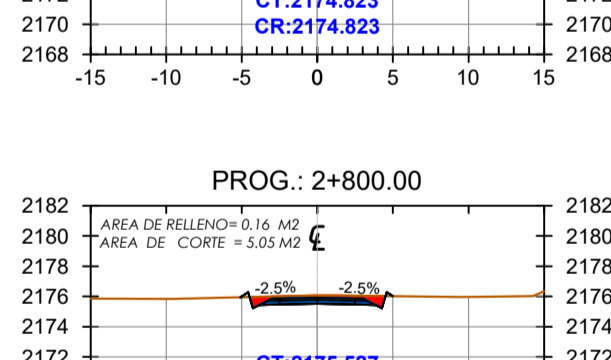
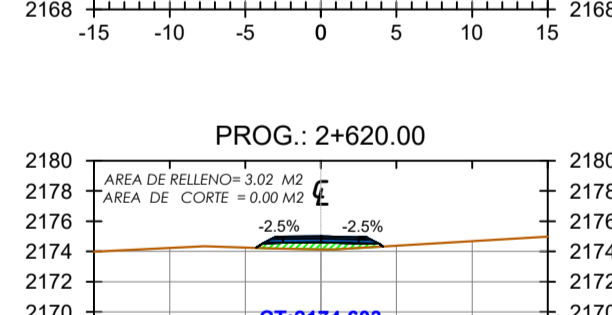
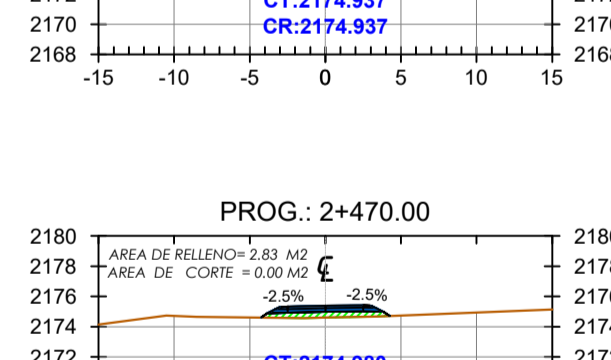
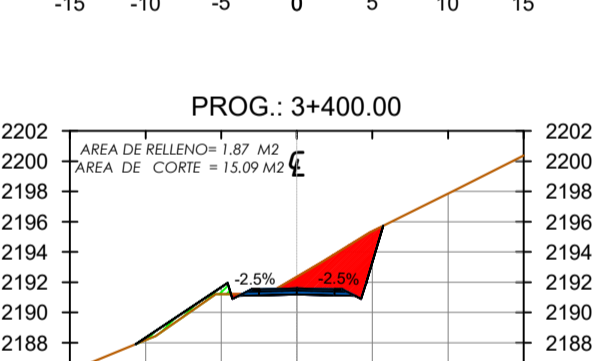
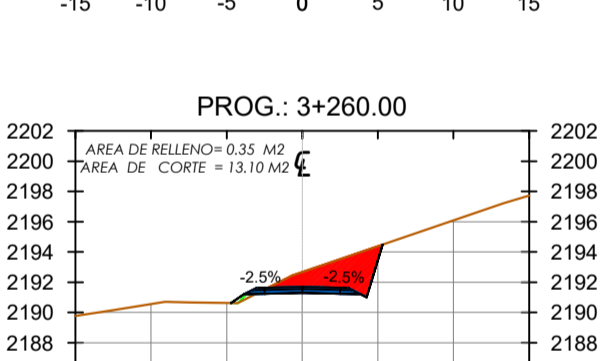
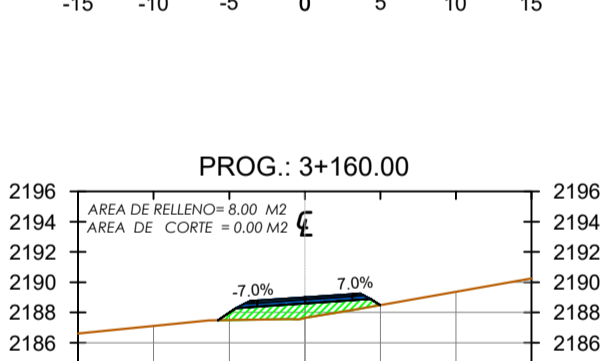
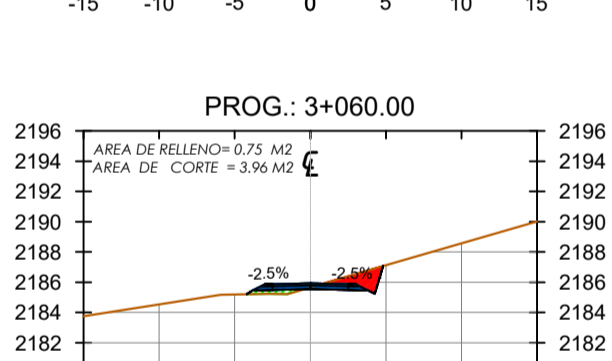
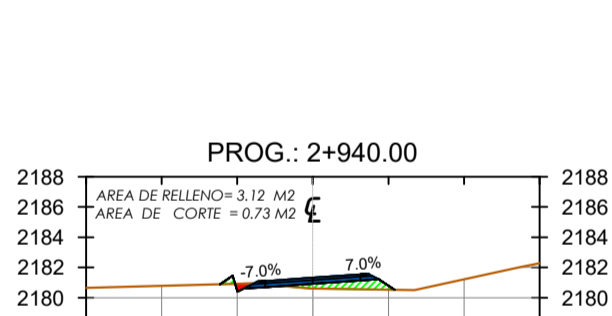
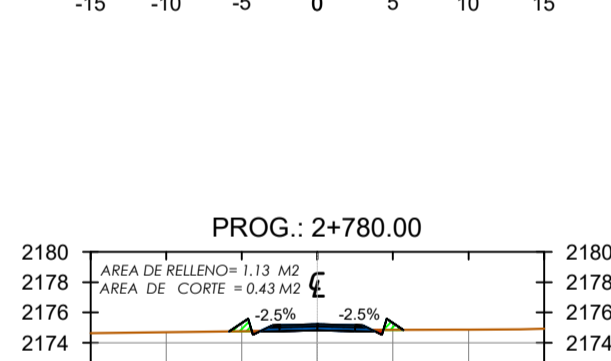
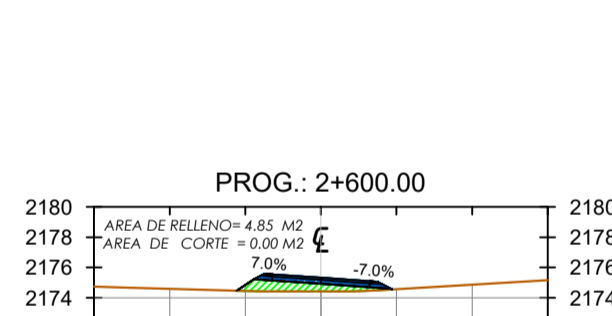
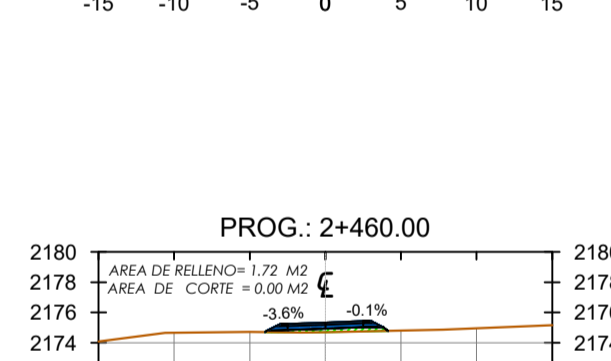
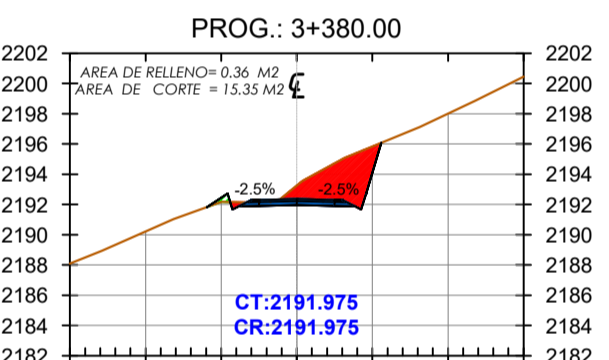
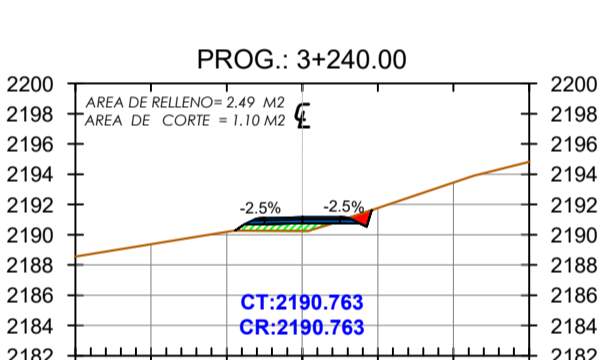
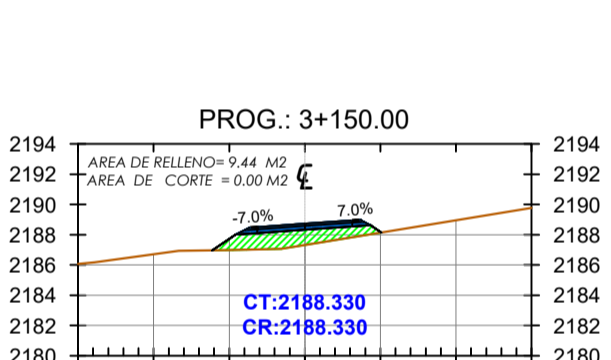
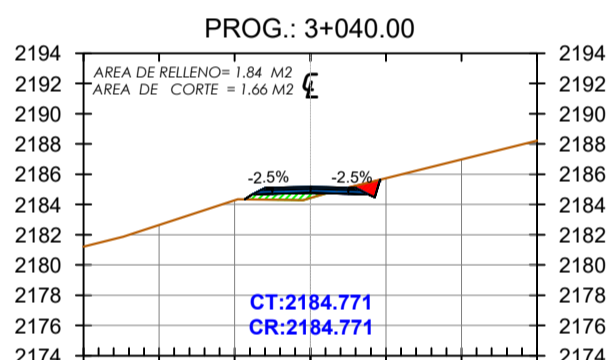
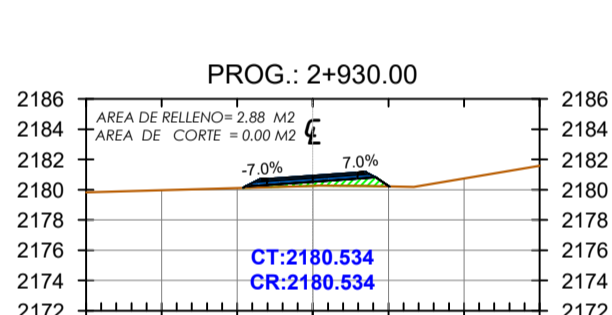
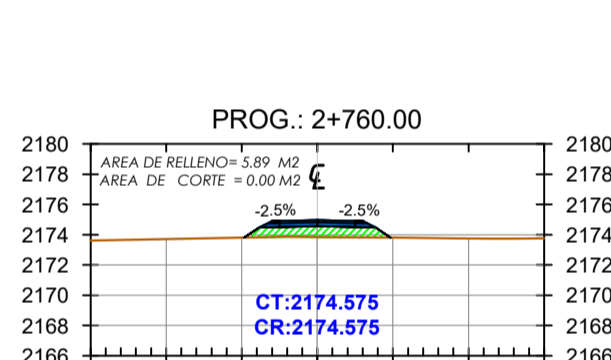
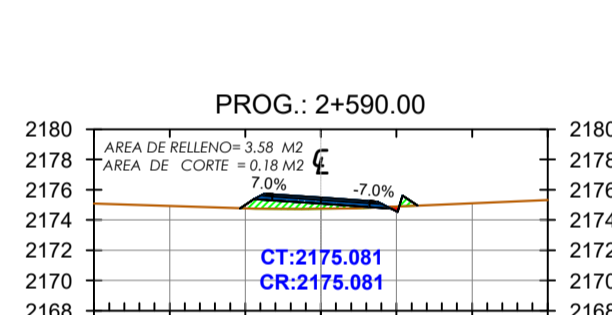
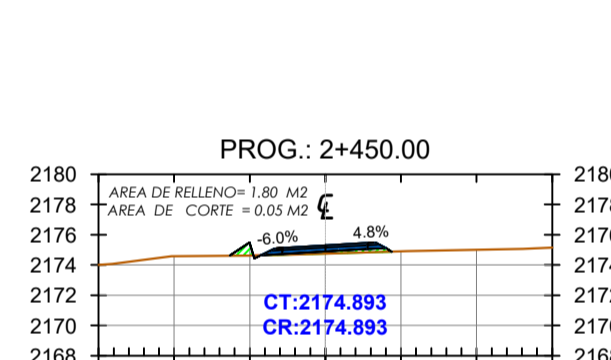
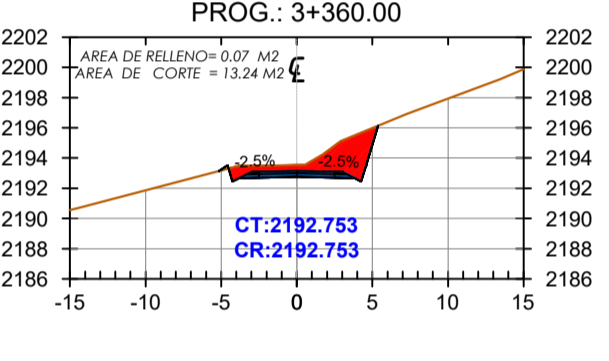
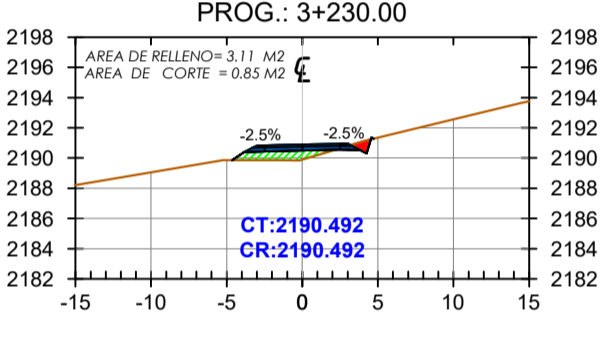
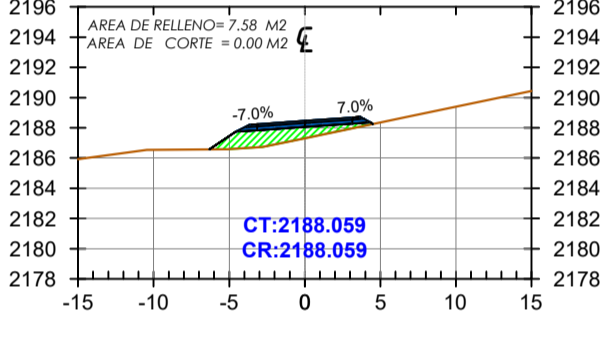
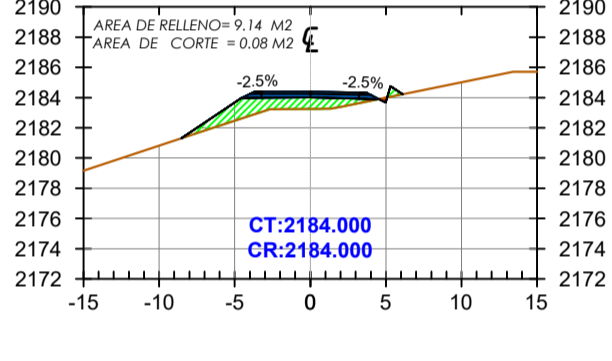
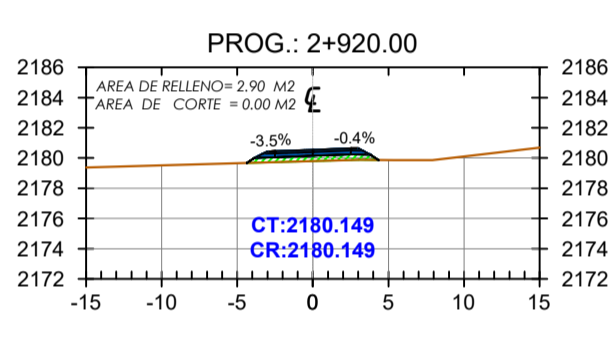
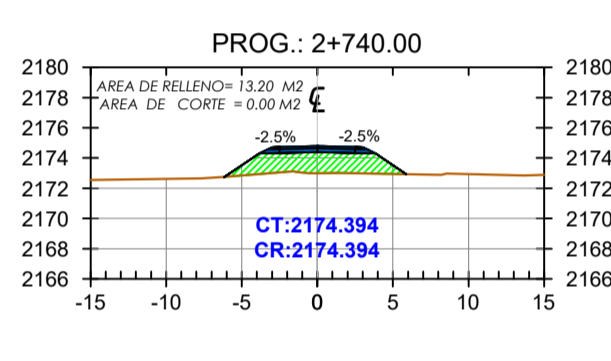
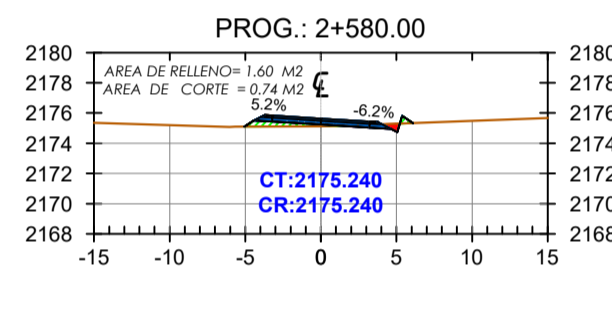
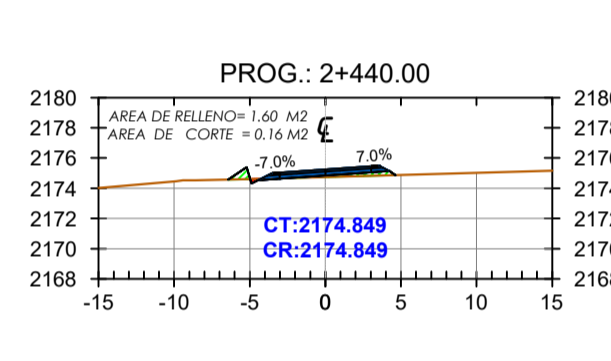
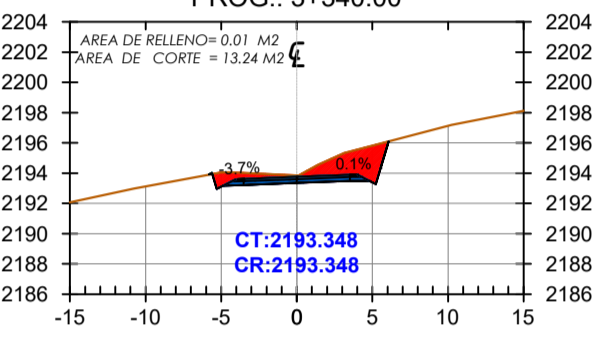
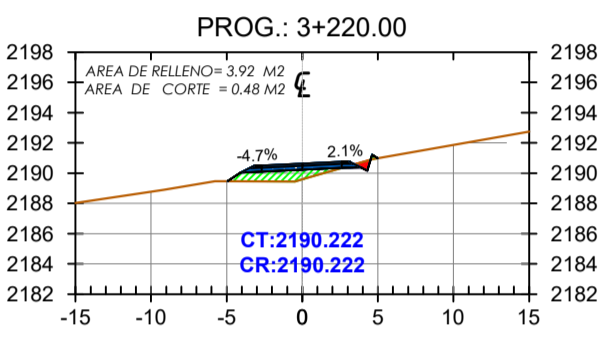
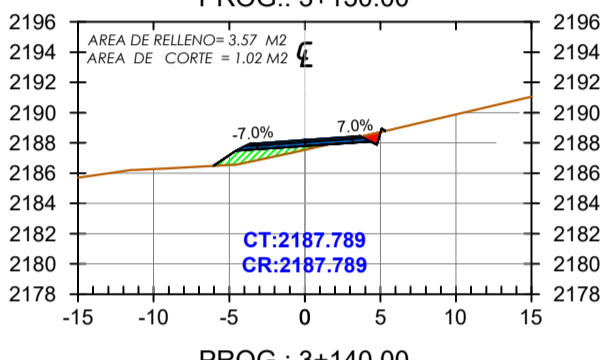
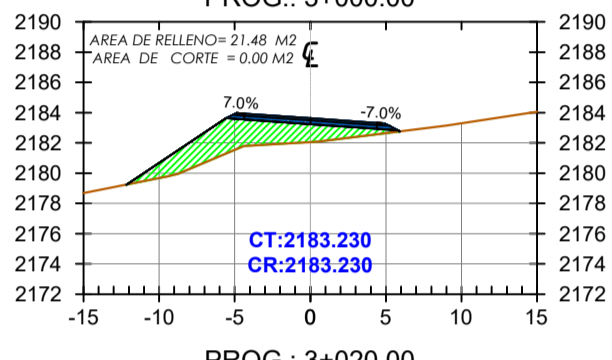
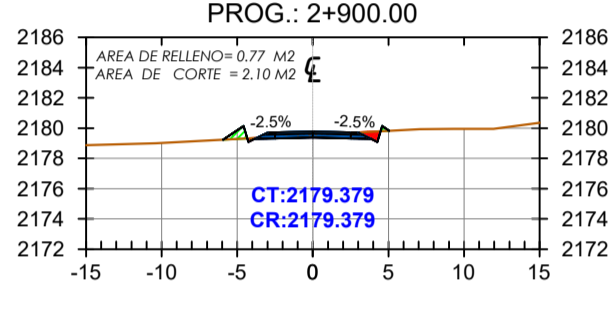
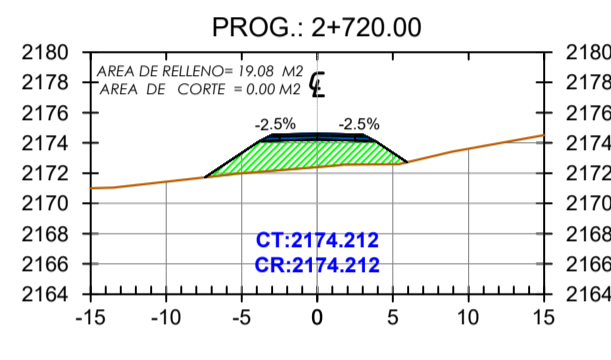
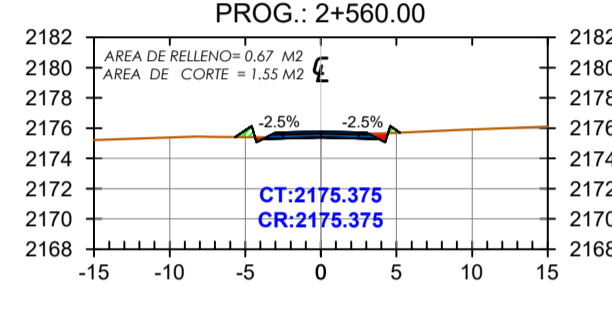
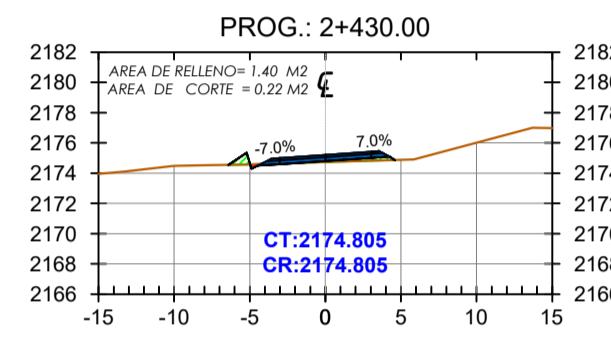
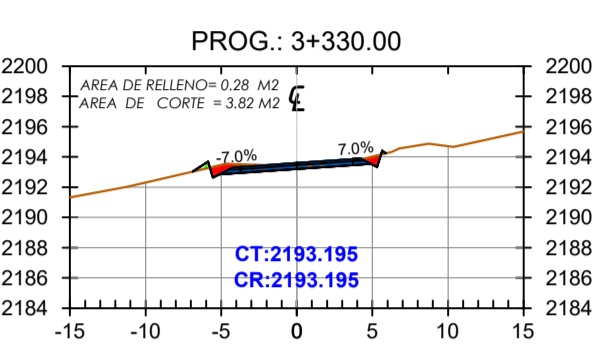
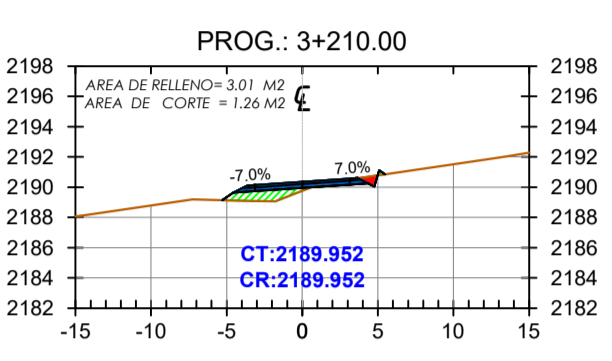
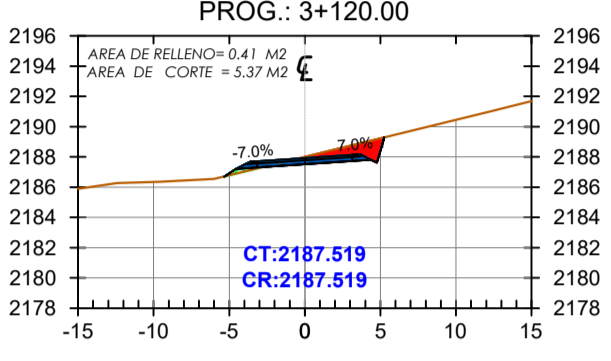
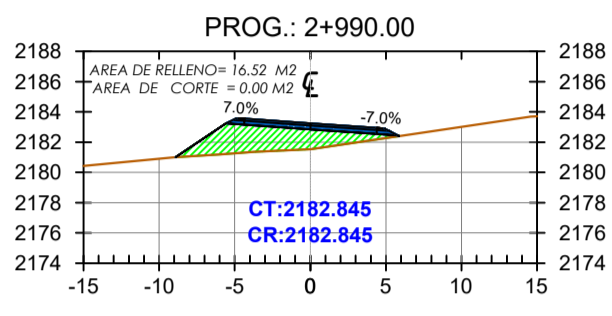
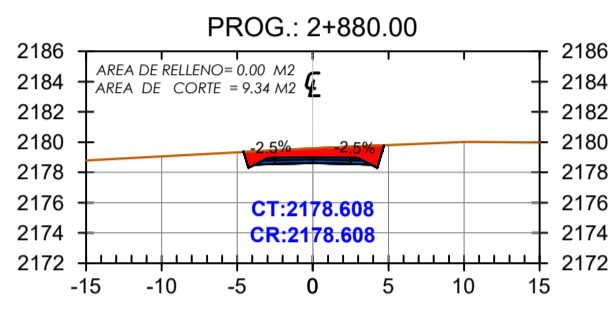
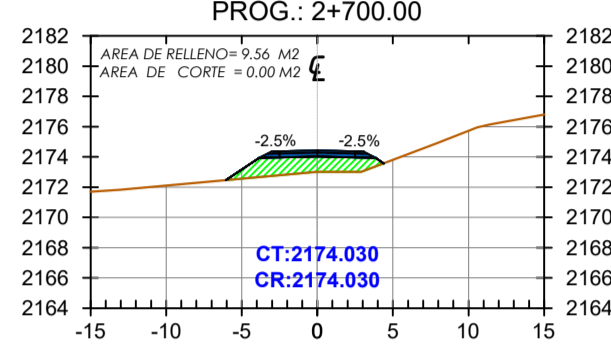
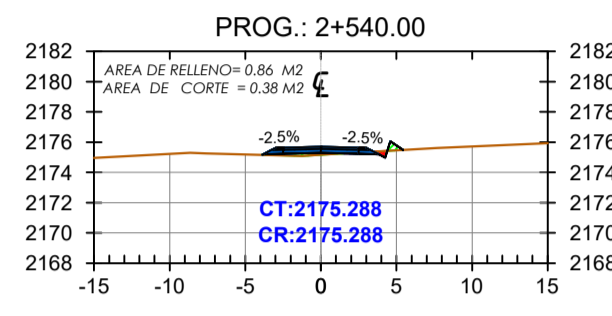
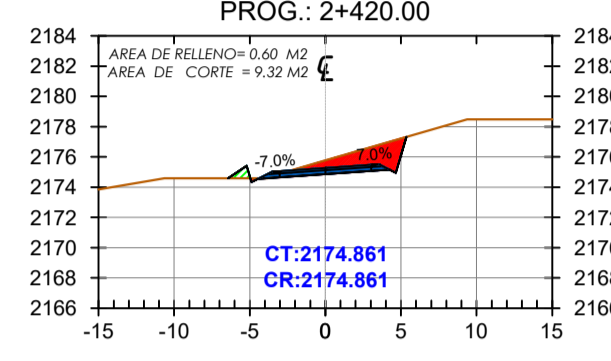
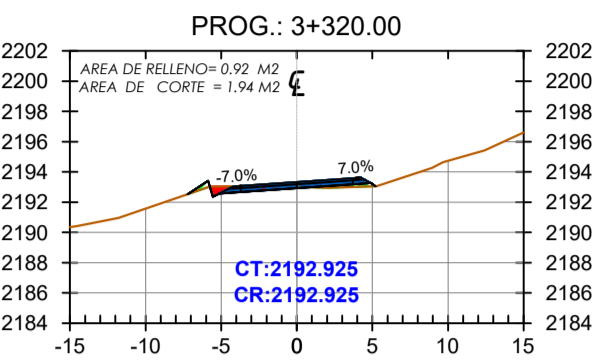
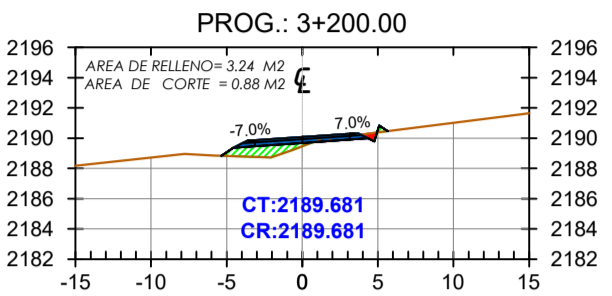
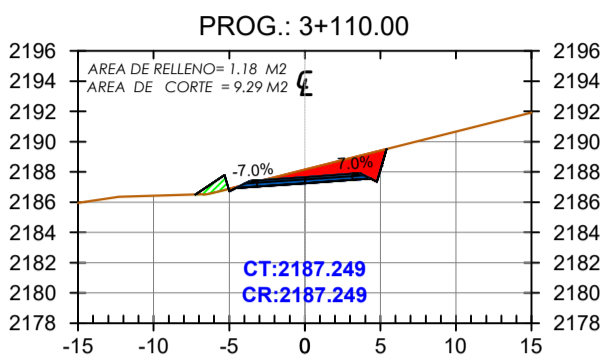
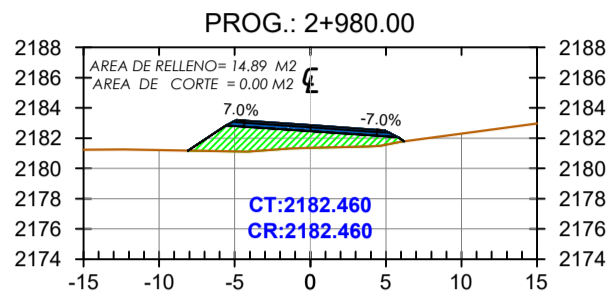
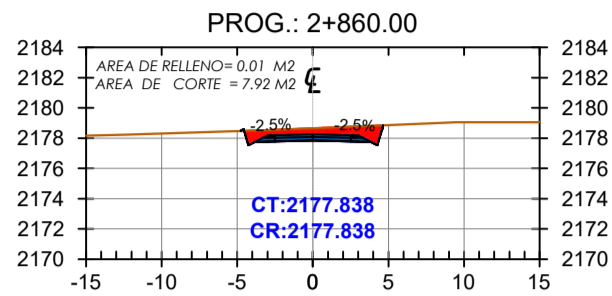
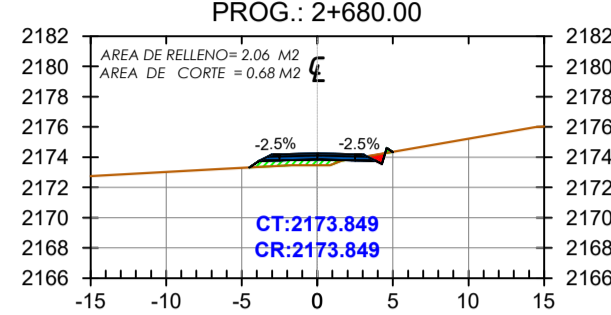
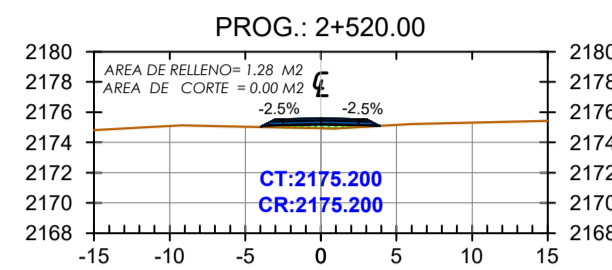
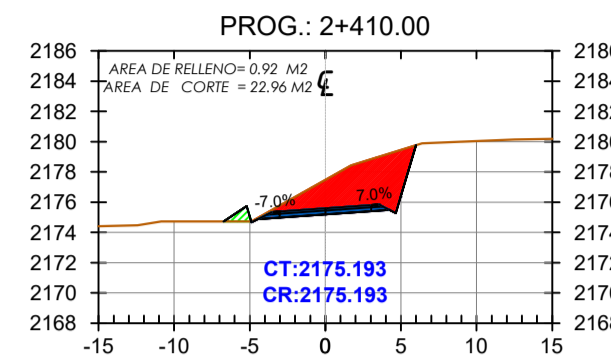

UNIVERSITARIO: BLADIMIR J. MARTINEZ MALLON

DOCENTE: MARCELO H. PACHECO NUÑES

UNIVERSIDAD AUTONOMA JUAN MISAEL SARACHO
 FACULTAD DE CIENCIAS Y TECNOLOGIA
 CARRERA DE INGENIERIA CIVIL
 ASIGNATURA: PROYECTO DE INGENIERIA CIVIL II CIV-502



Proyecto:

DISEÑO DE INGENIERIA TRAMO CARLAZO CENTRO - CARLAZO ESTE

Revisión:

Título: SECCIONES TRANSVERSALES

Escalas: 1:500
 Progresivas: De: 2+410 A: 3+400
 N° de Lámina: 03/09

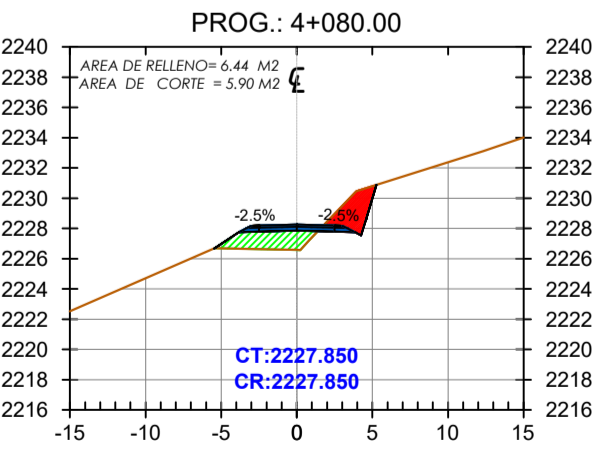
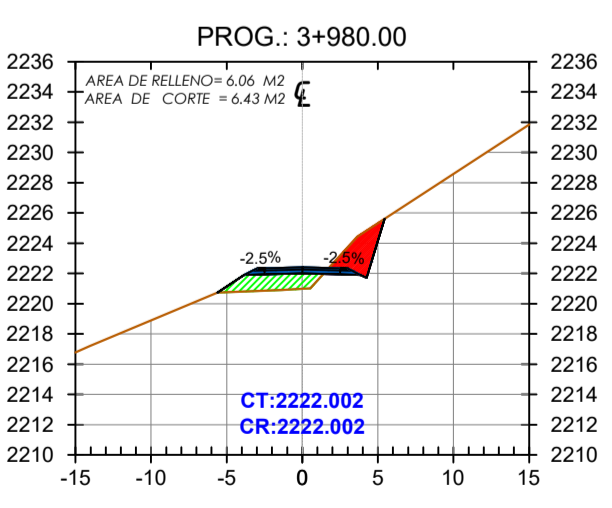
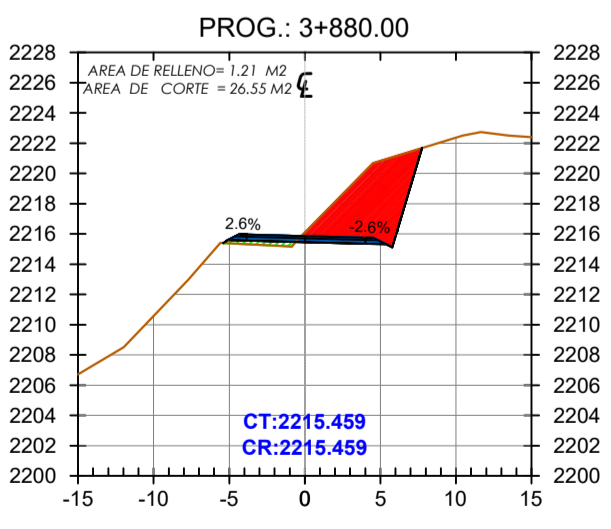
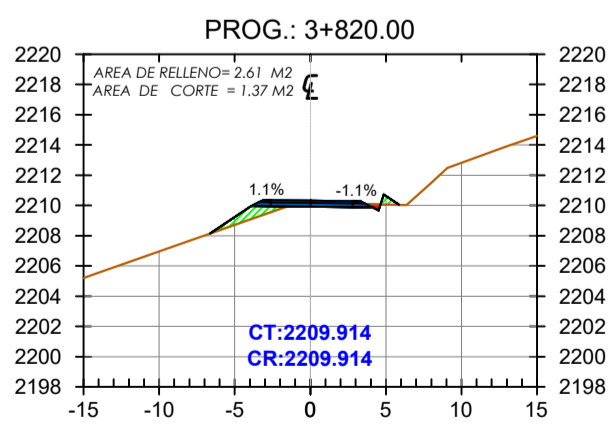
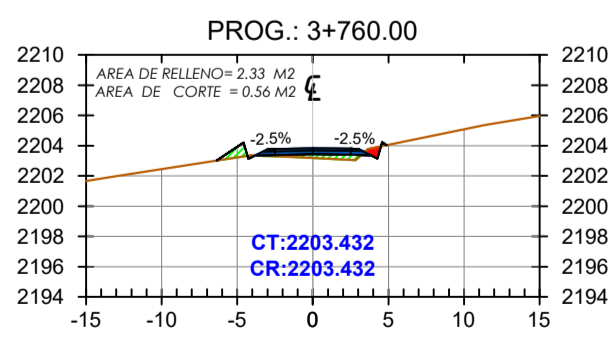
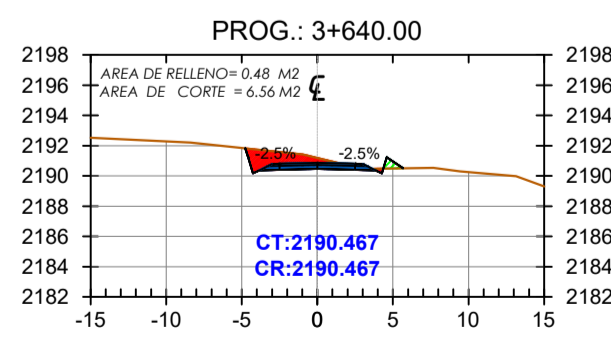
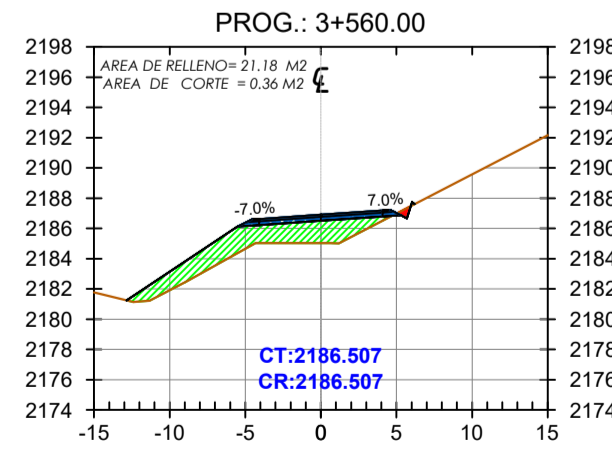
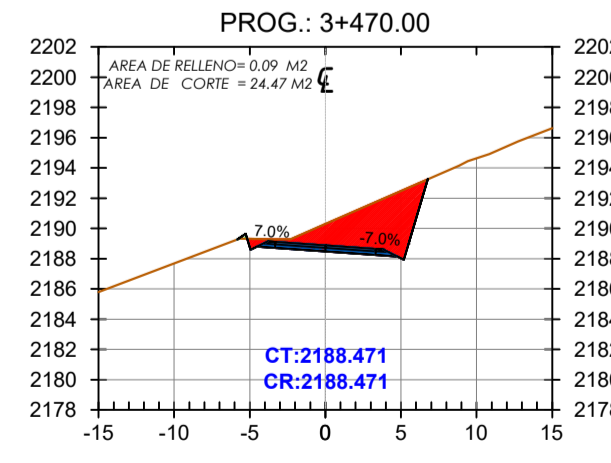
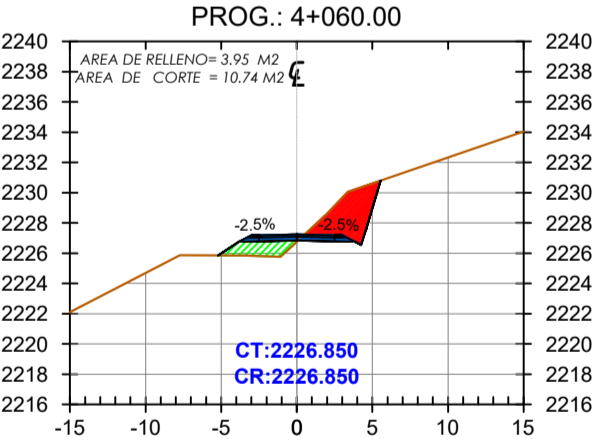
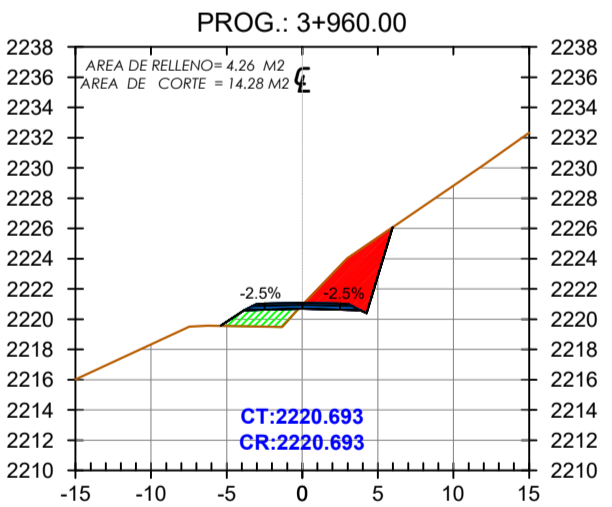
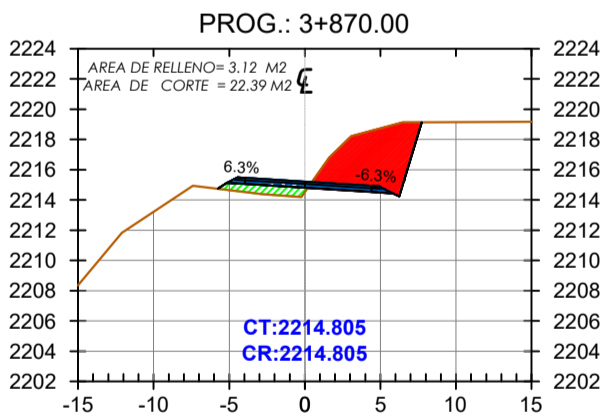
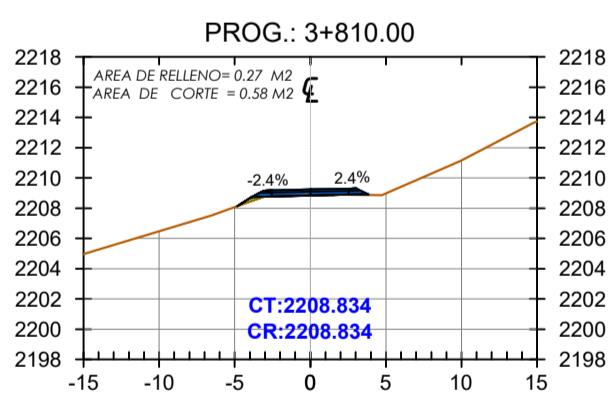
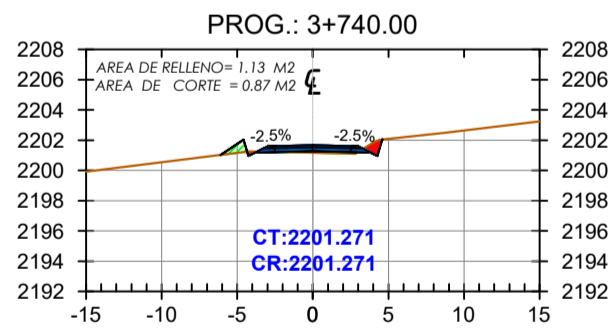
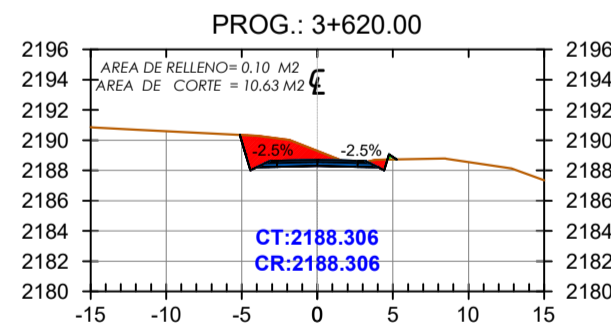
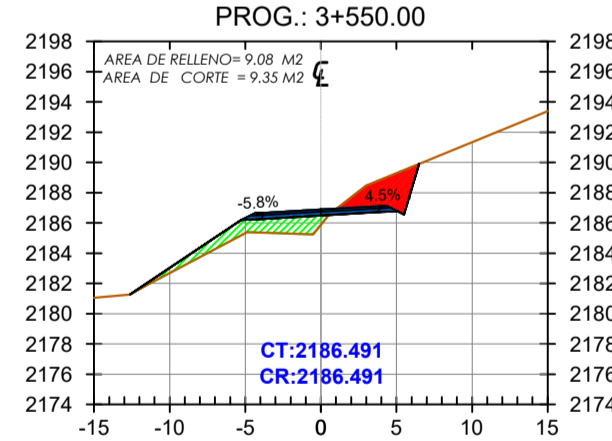
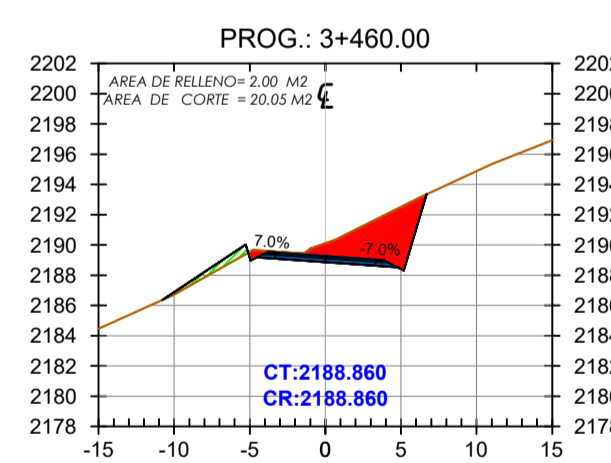
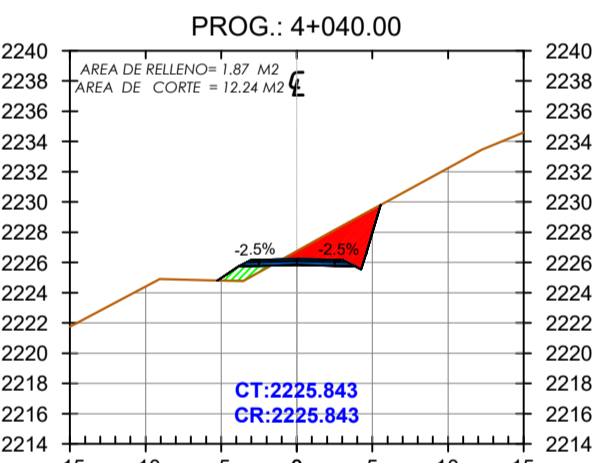
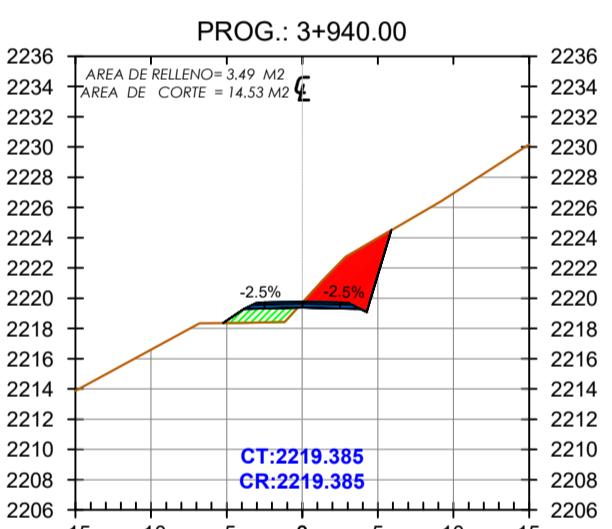
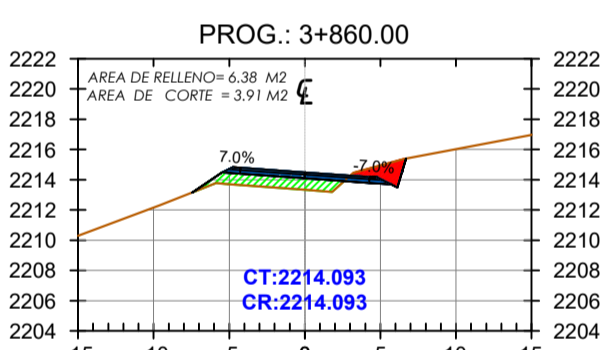
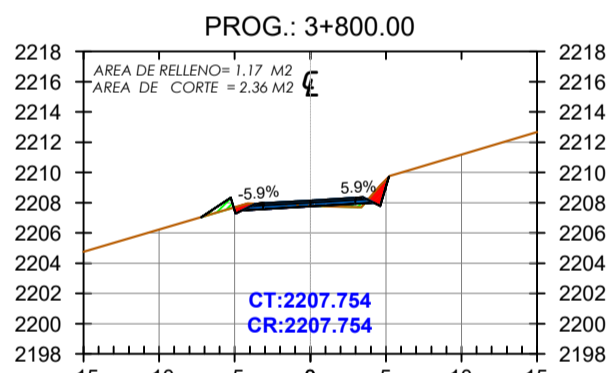
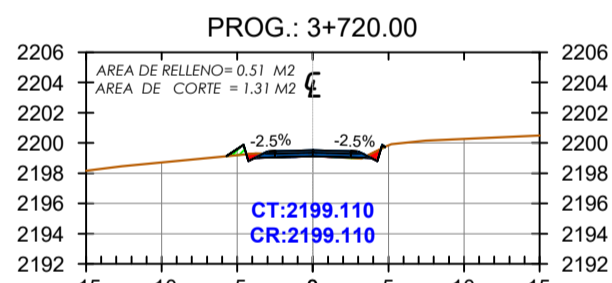
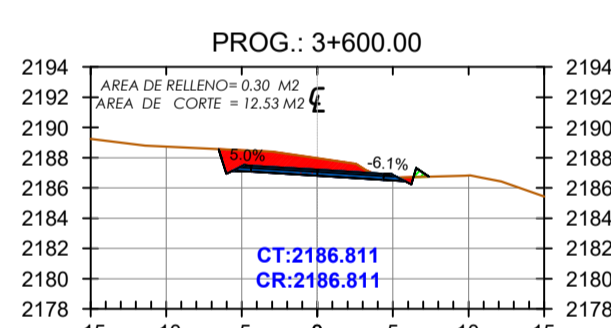
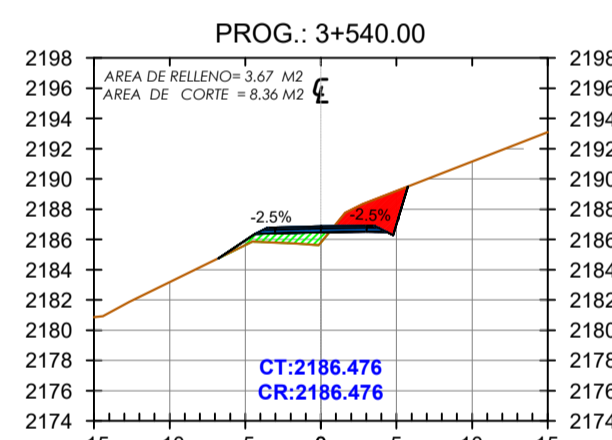
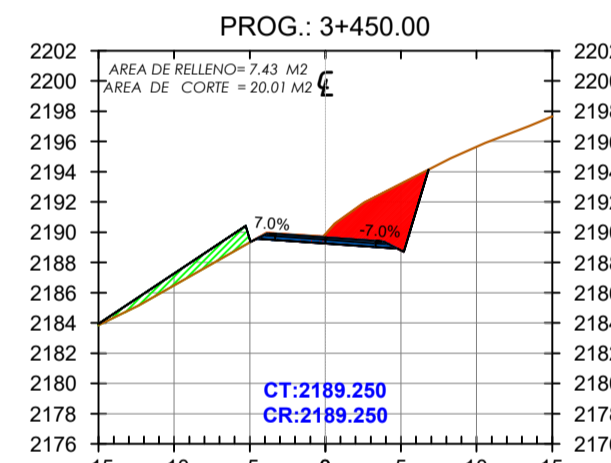
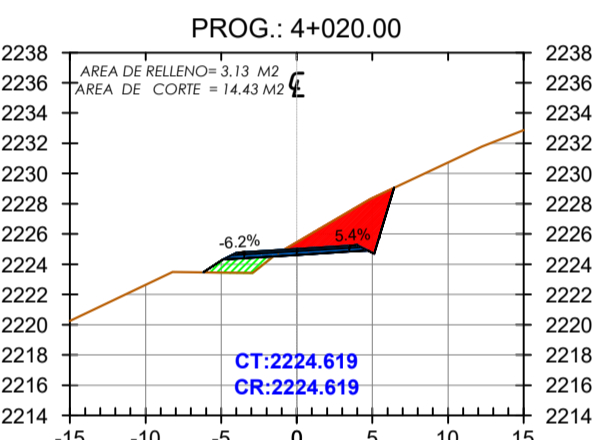
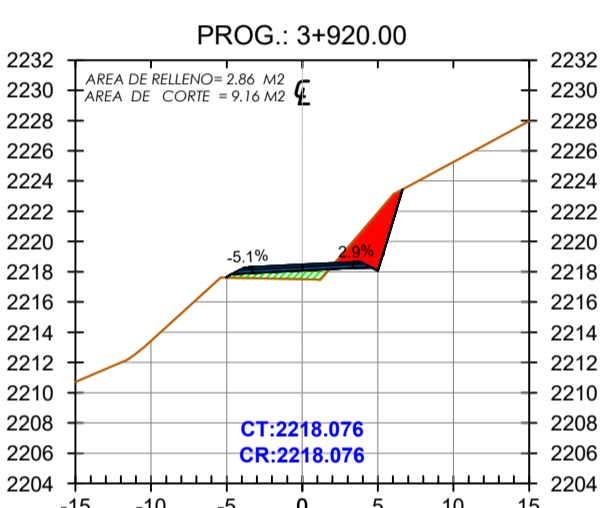
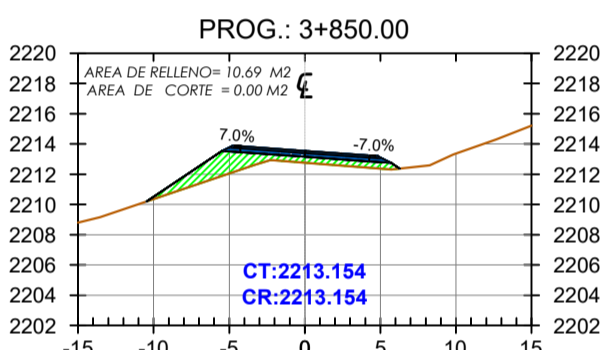
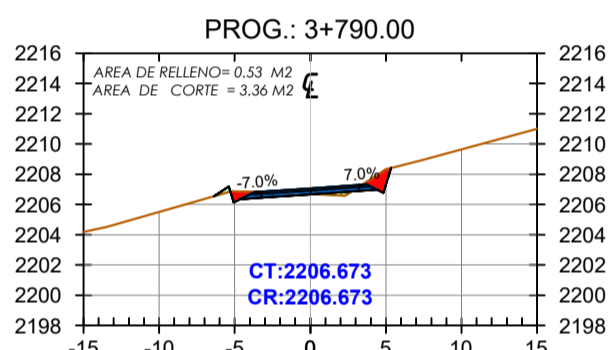
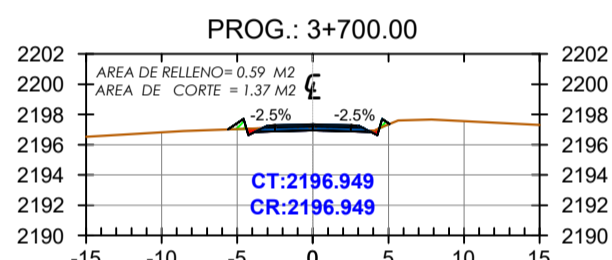
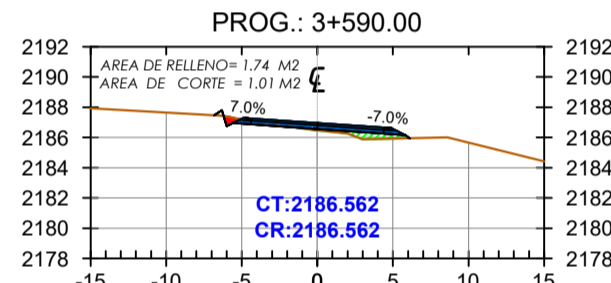
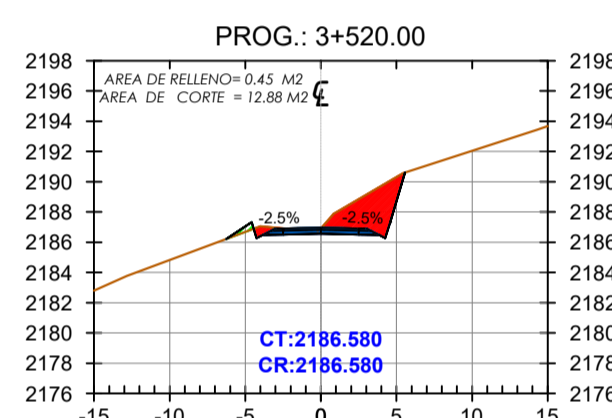
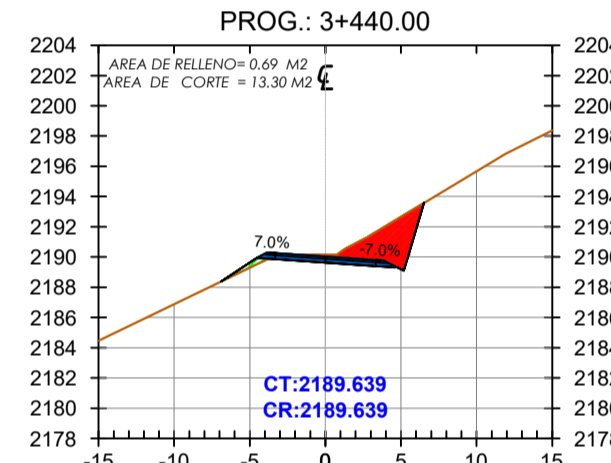
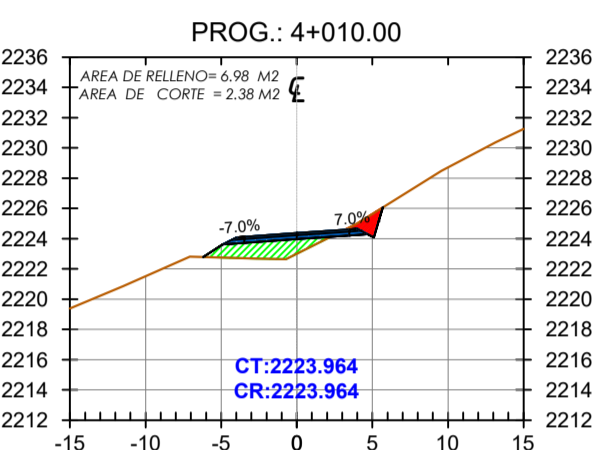
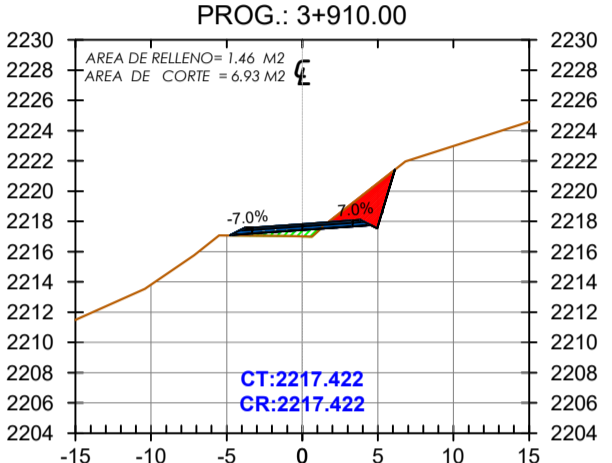
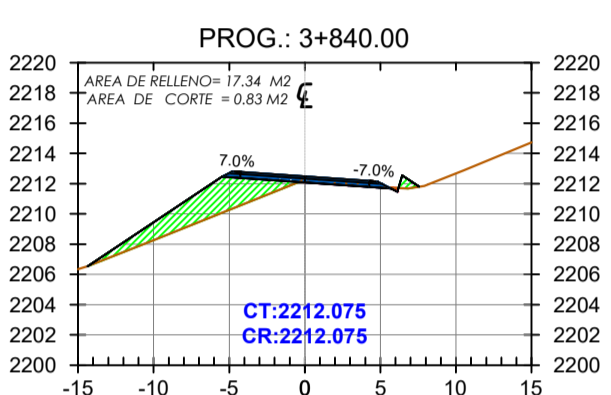
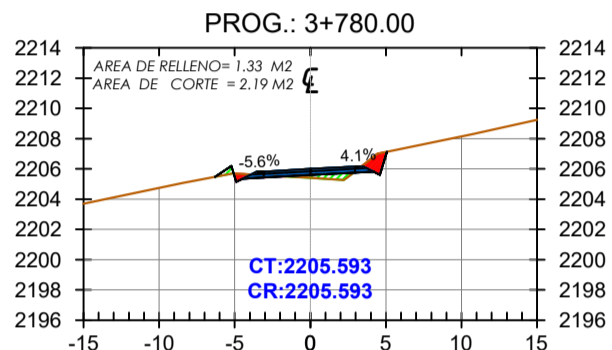
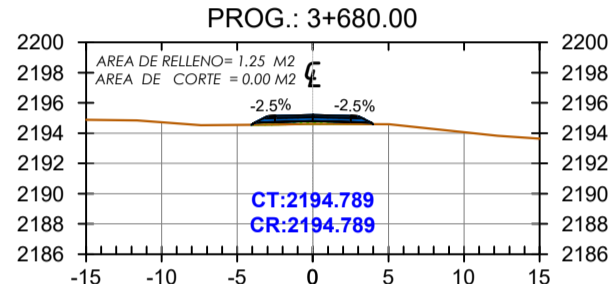
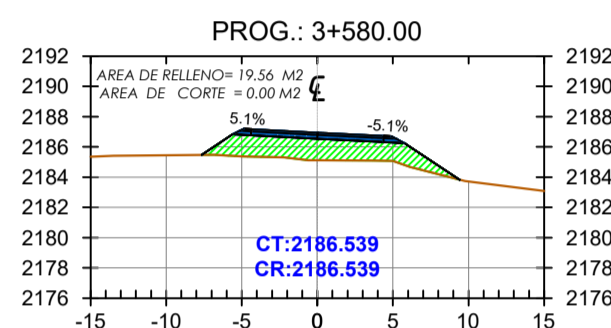
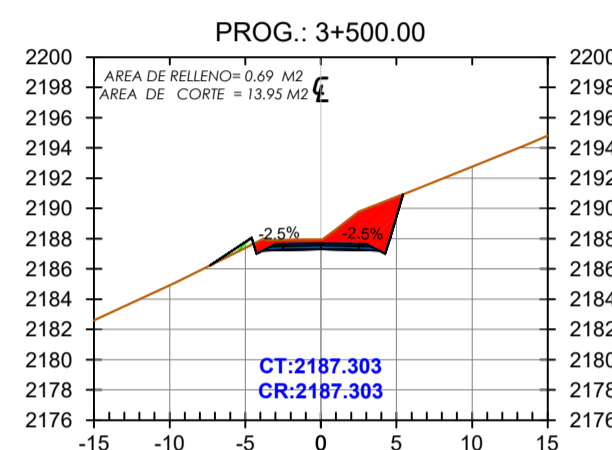
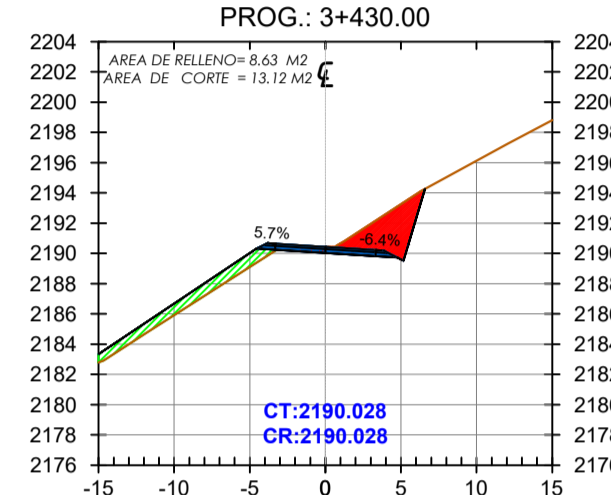
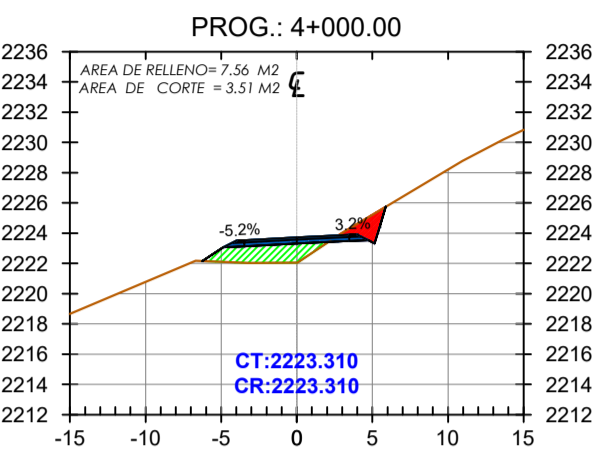
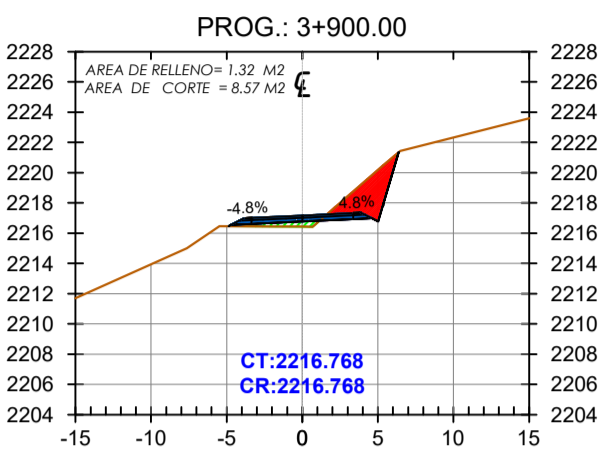
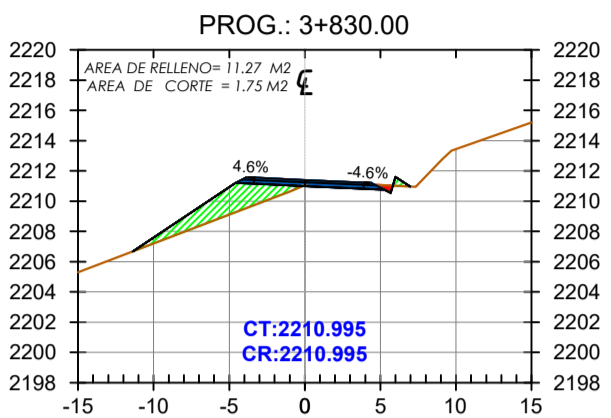
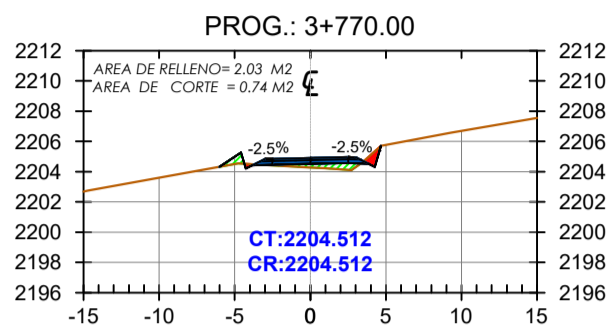
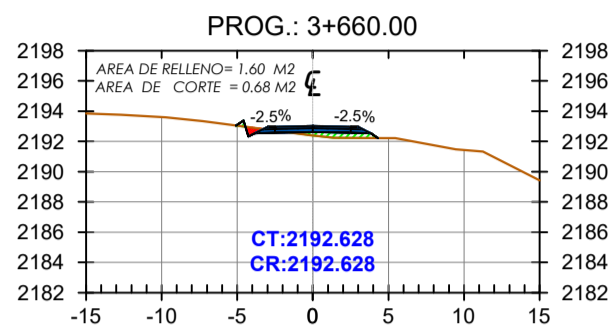
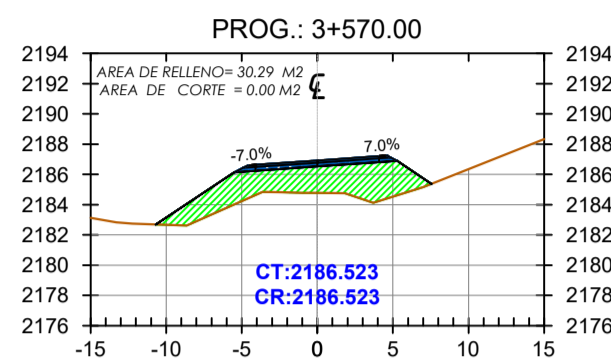
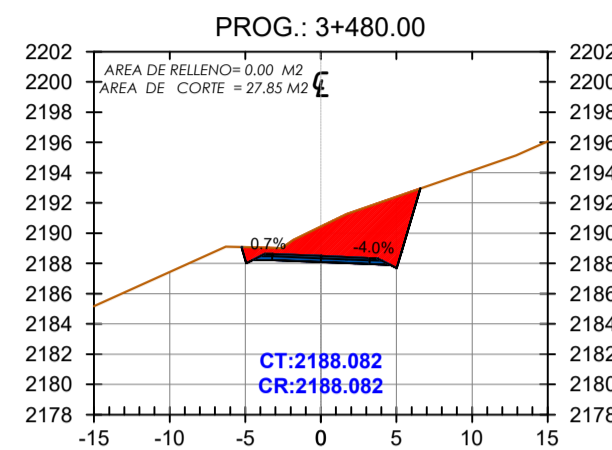
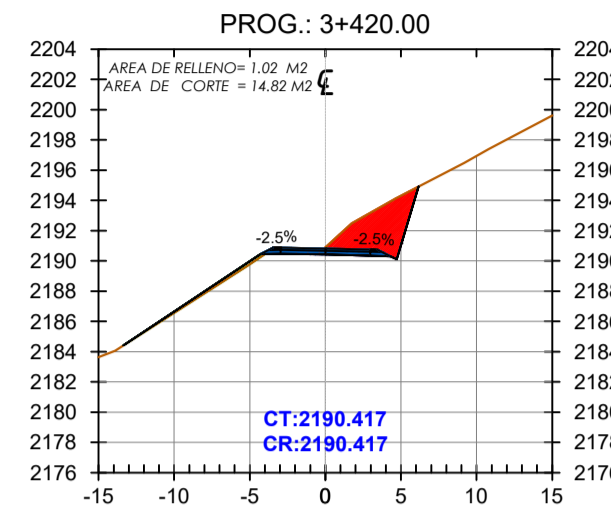

UNIVERSITARIO: BLADIMIR J. MARTINEZ MALLON
DOCENTE: MARCELO H. PACHECO NUÑES

UNIVERSIDAD AUTONOMA JUAN MISAEL SARACHO
FACULTAD DE CIENCIAS Y TECNOLOGIA
CARRERA DE INGENIERIA CIVIL
ASIGNATURA: PROYECTO DE INGENIERIA CIVIL II CIV-502



Proyecto: DISEÑO DE INGENIERIA TRAMO CARLAZO CENTRO - CARLAZO ESTE

Revisión:

Título: SECCIONES TRANSVERSALES

Escalas: 1:500
Progresivas: De: 3+420 A: 4+080
Nº de Lámina: 04/09

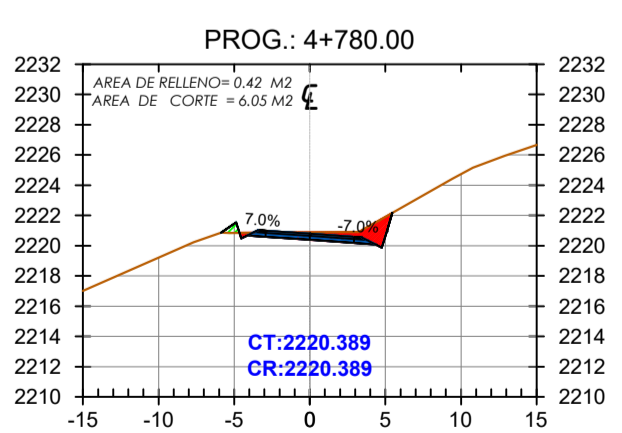
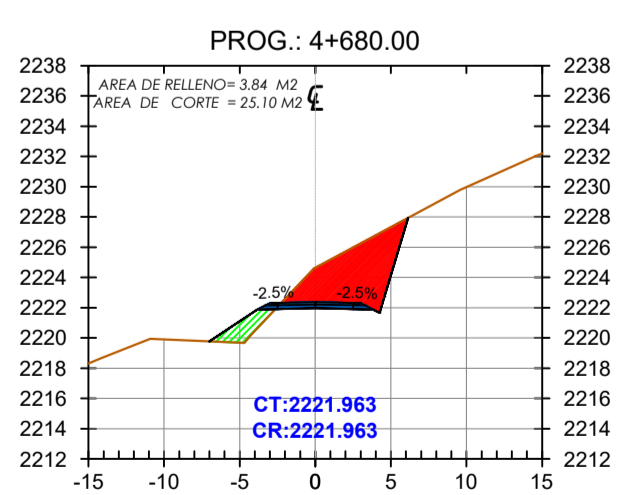
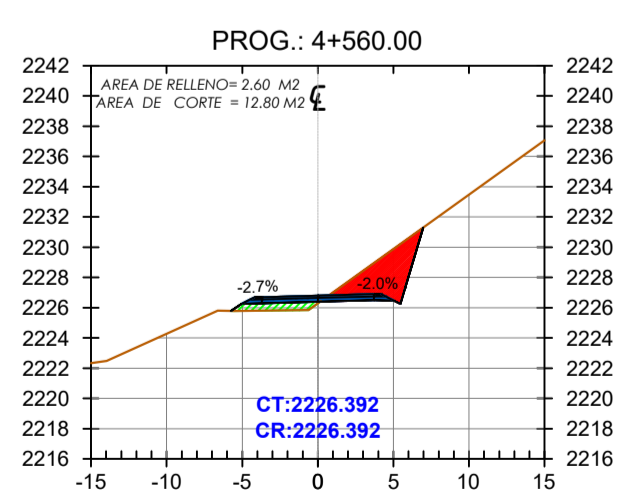
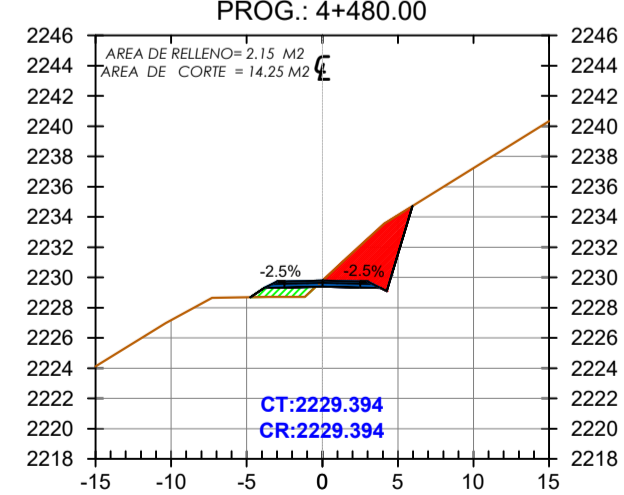
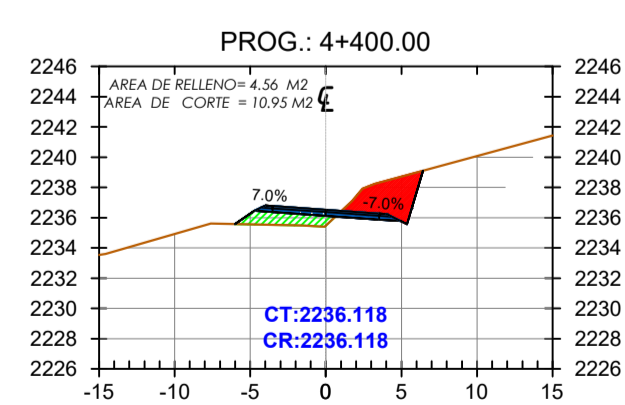
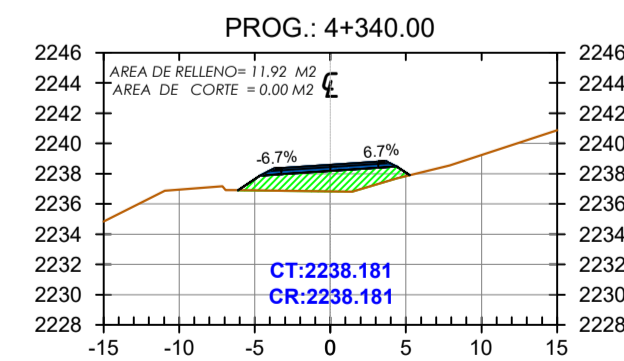
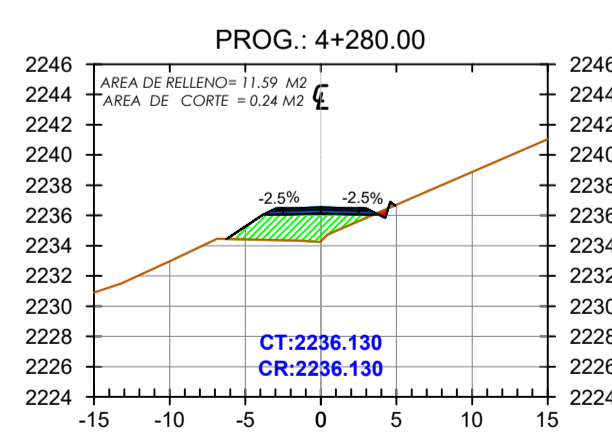
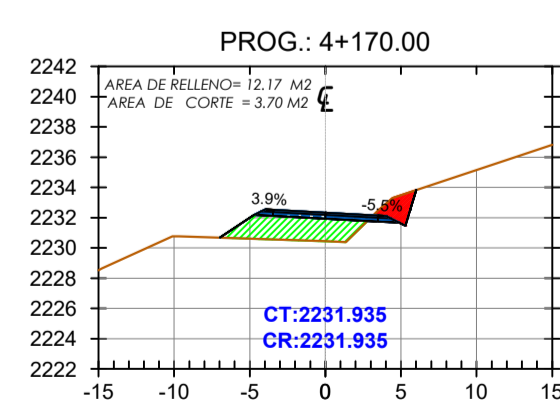
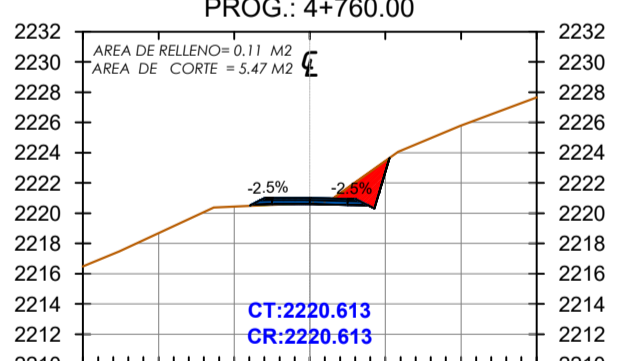
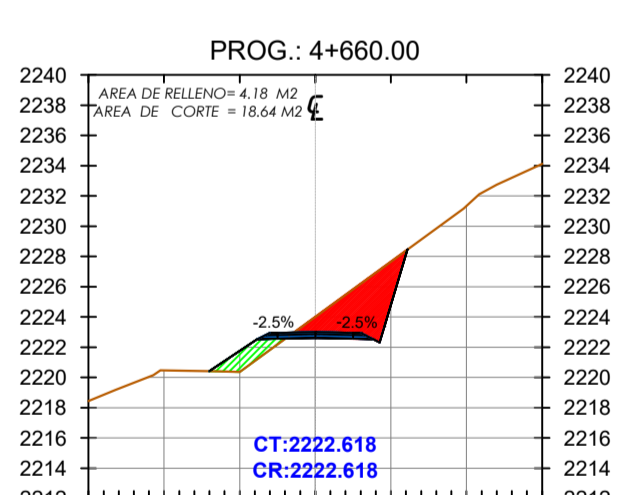
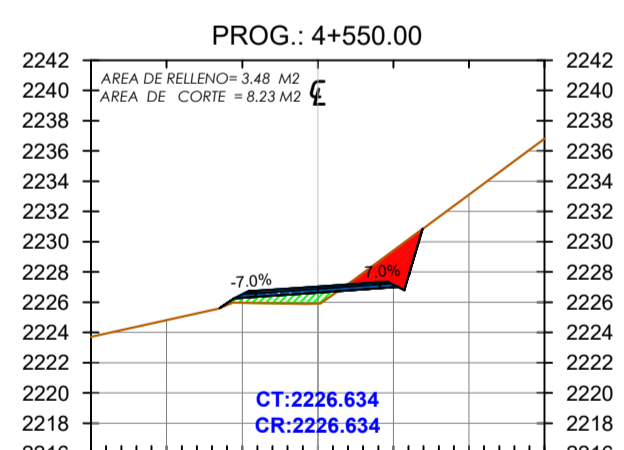
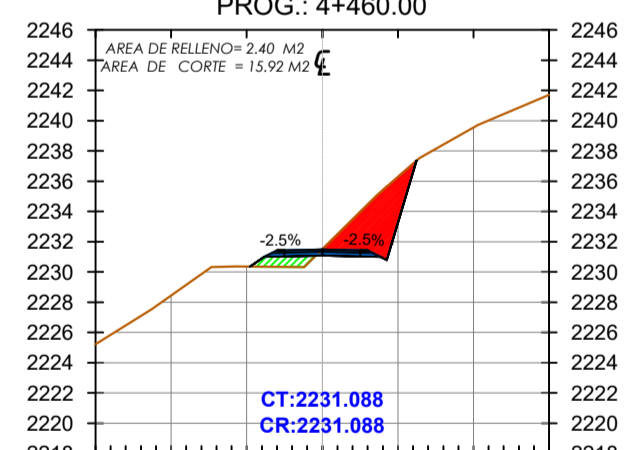
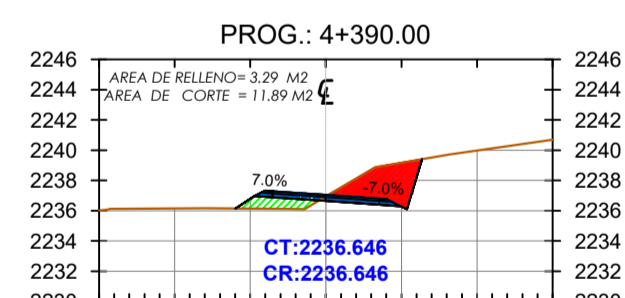
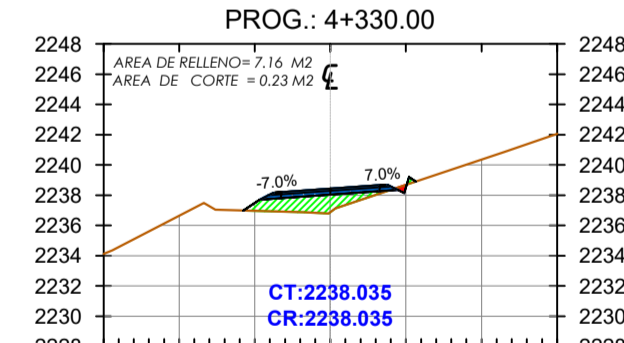
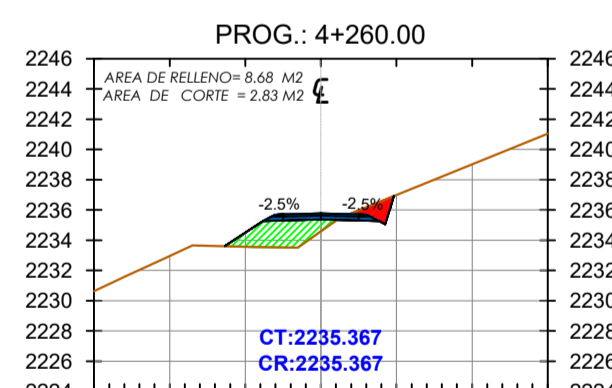
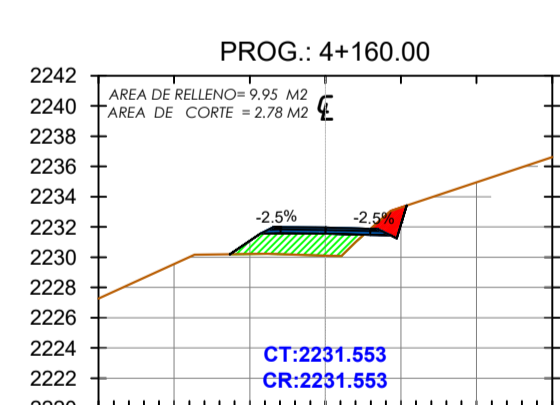
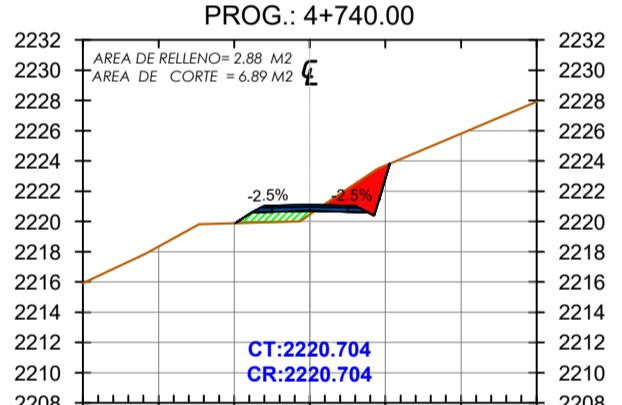
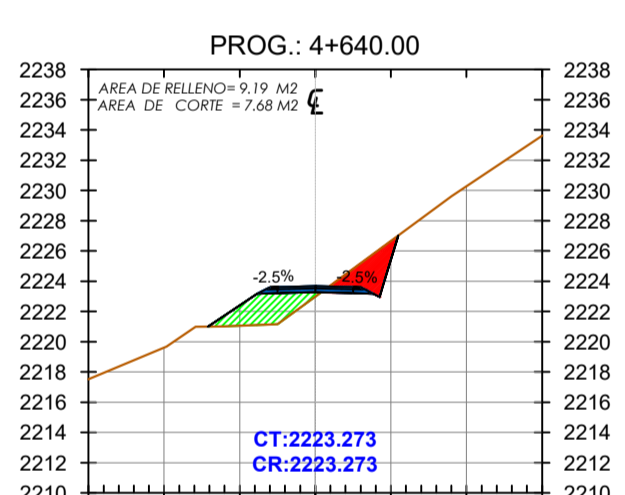
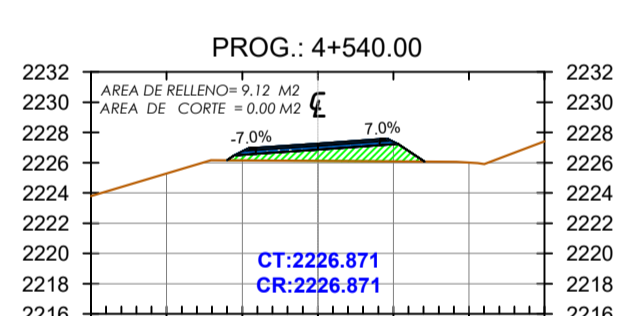
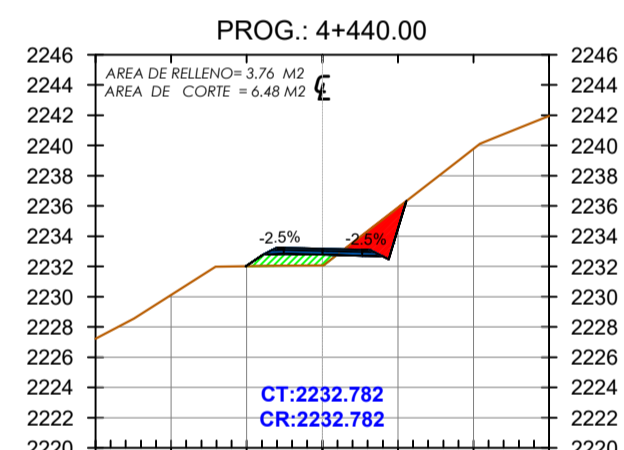
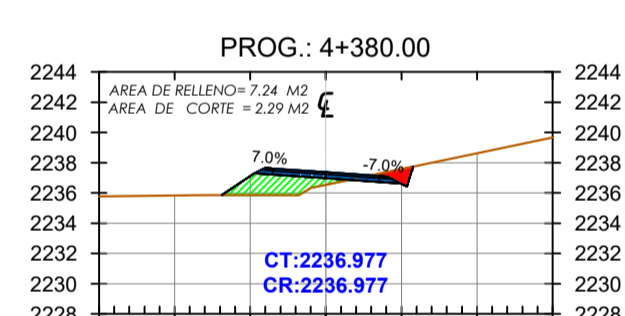
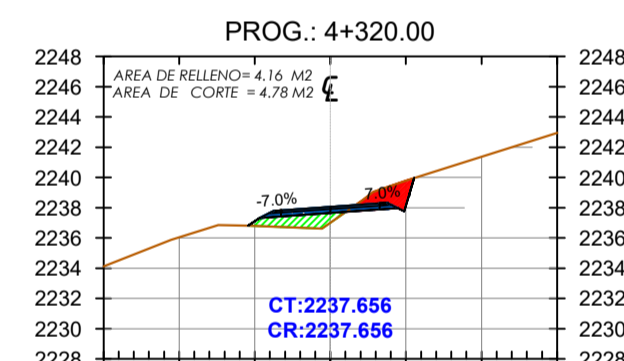
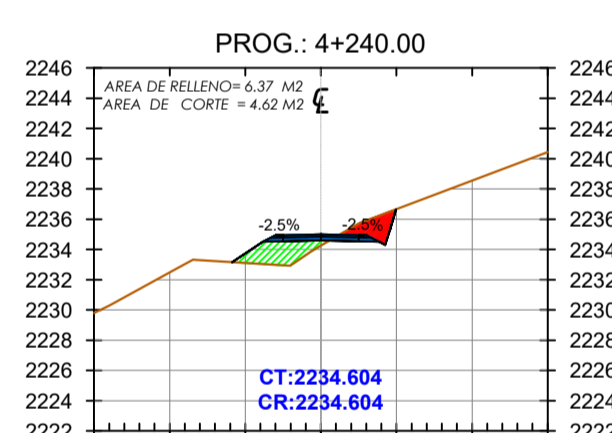
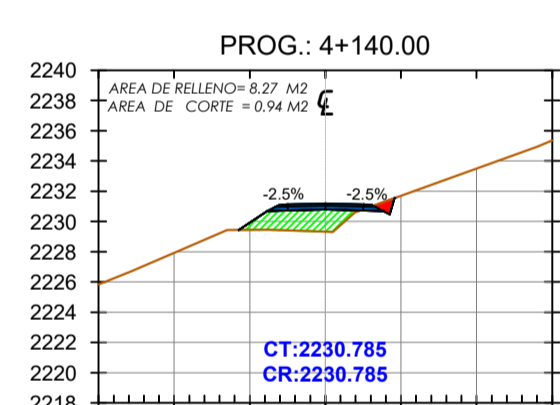
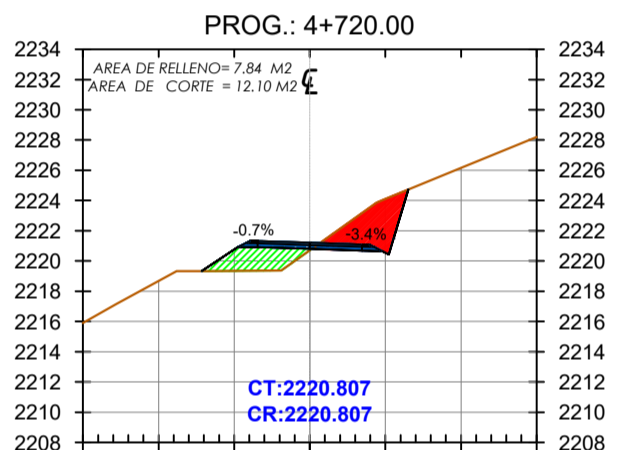
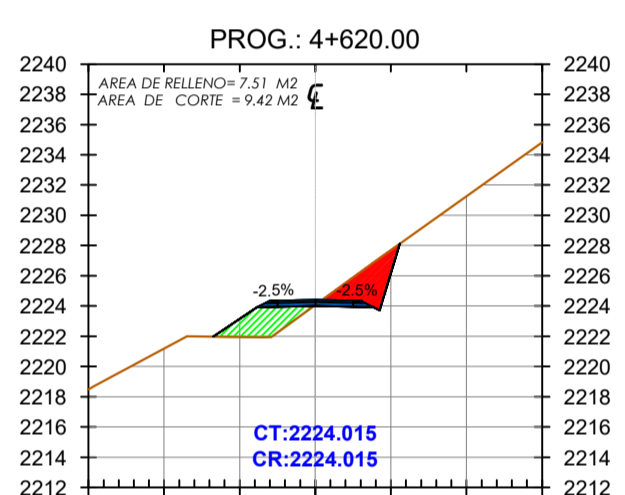
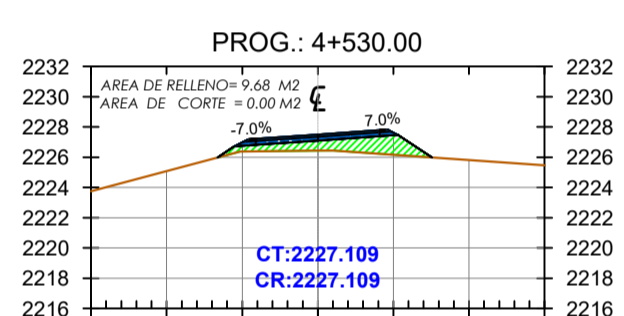
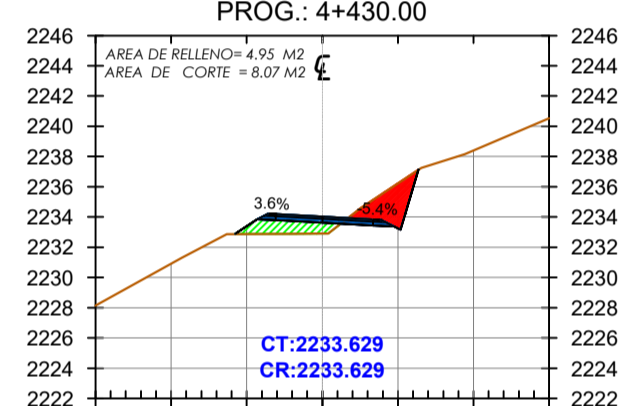
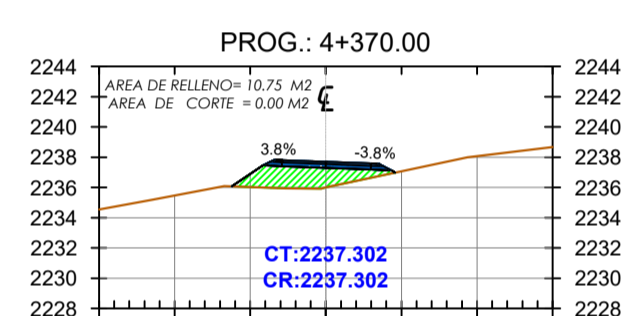
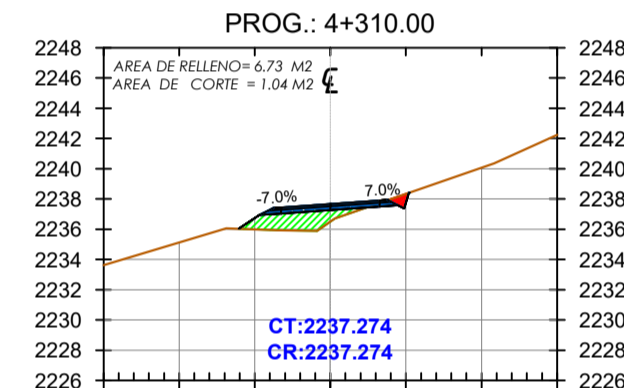
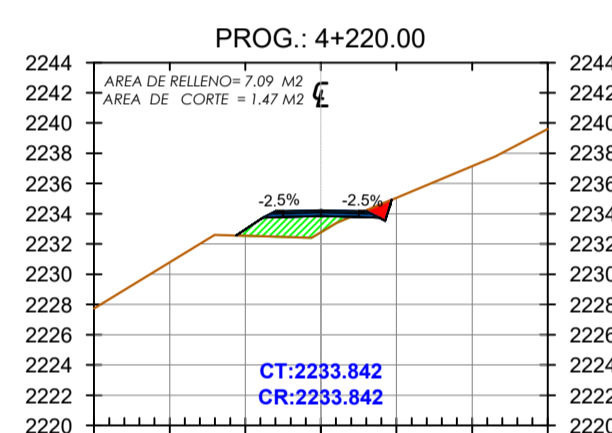
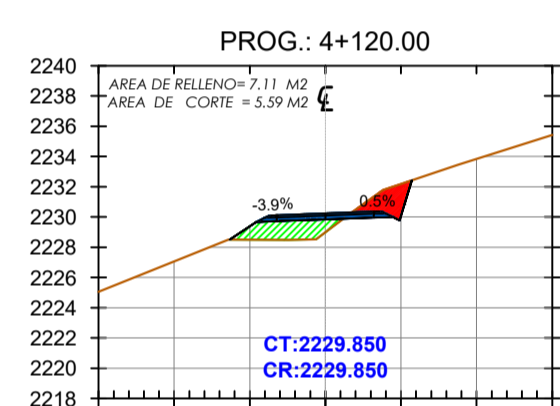
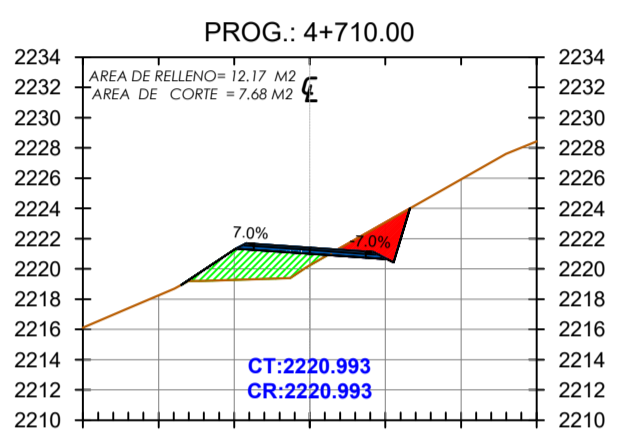
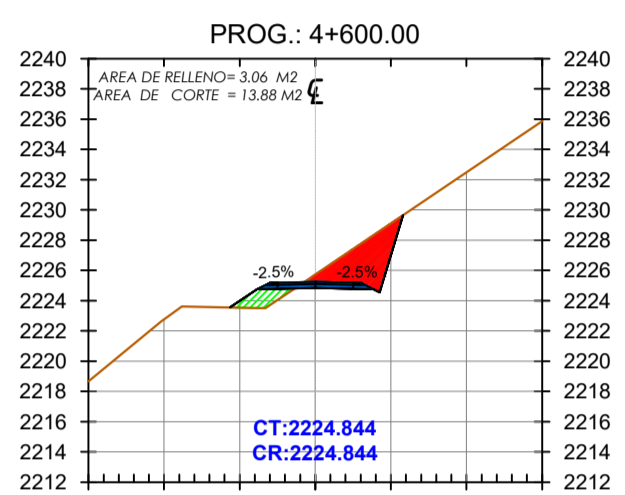
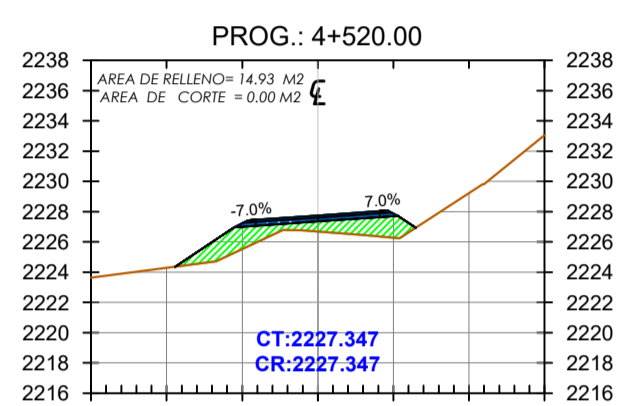
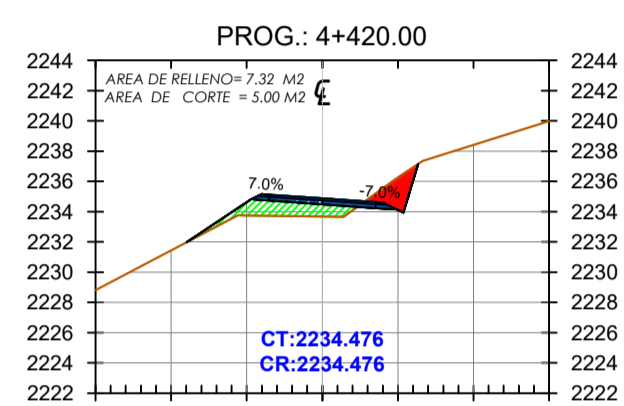
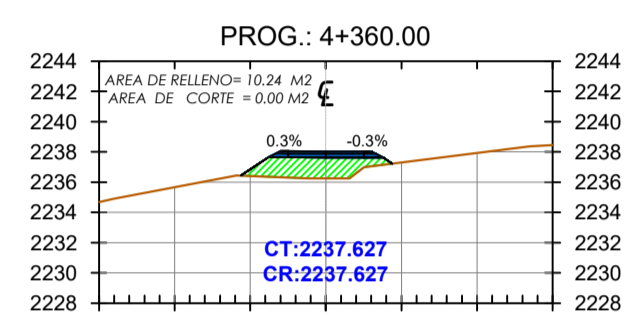
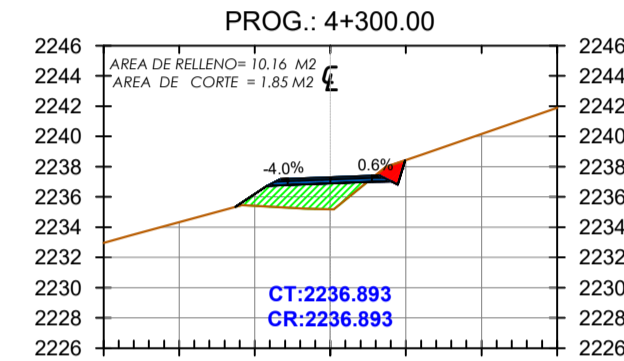
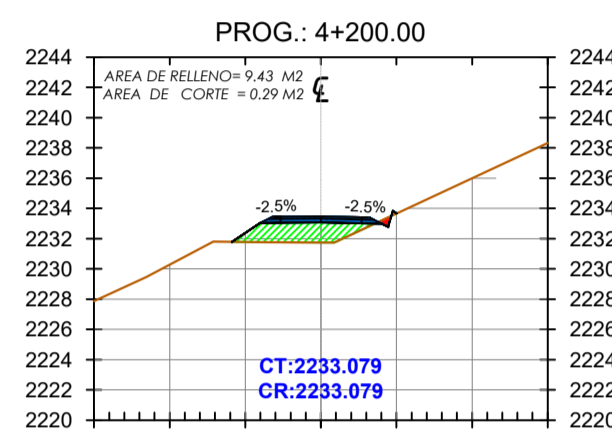
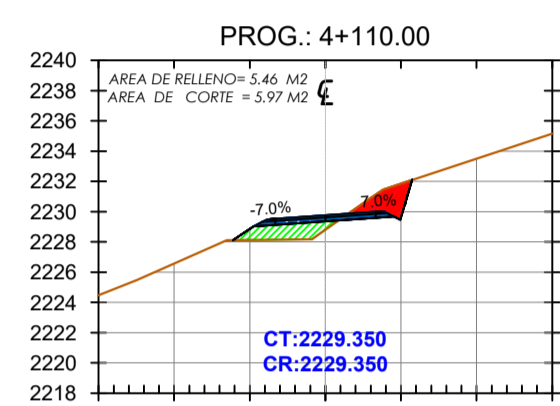
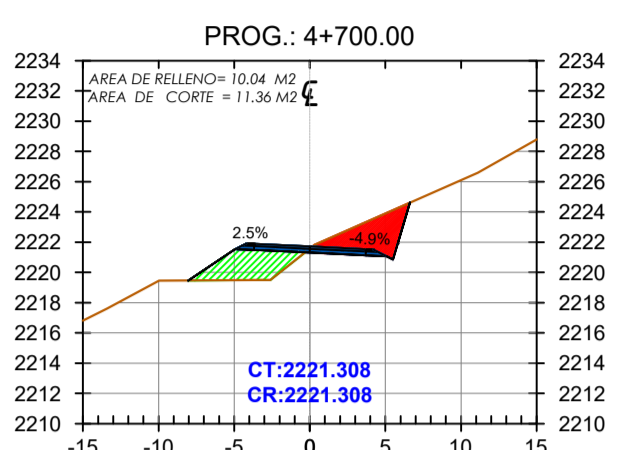
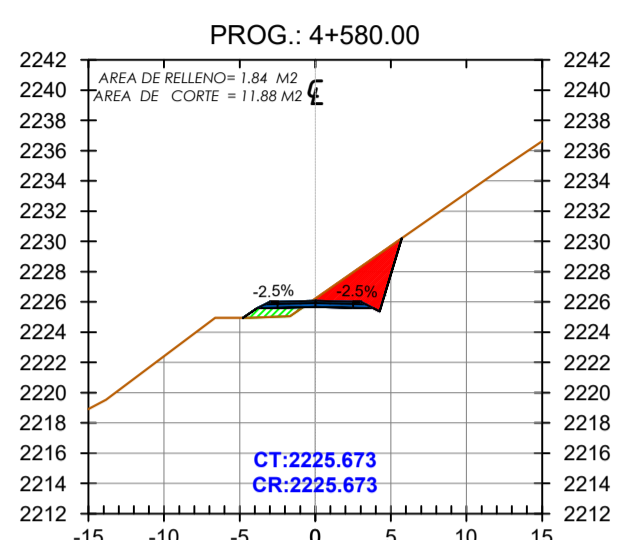
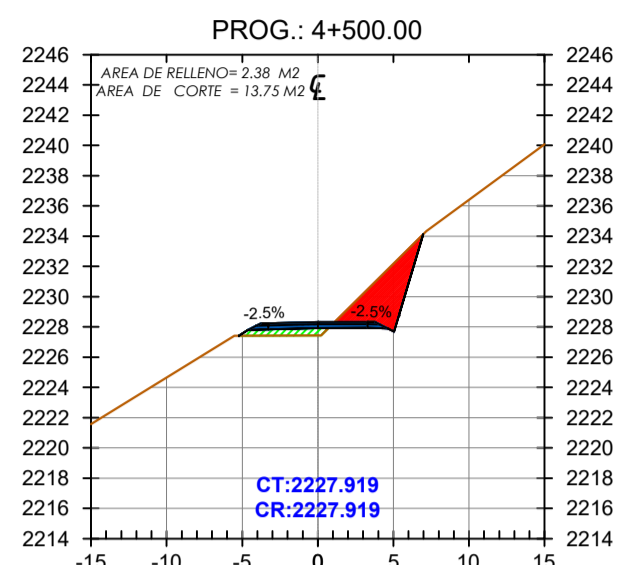
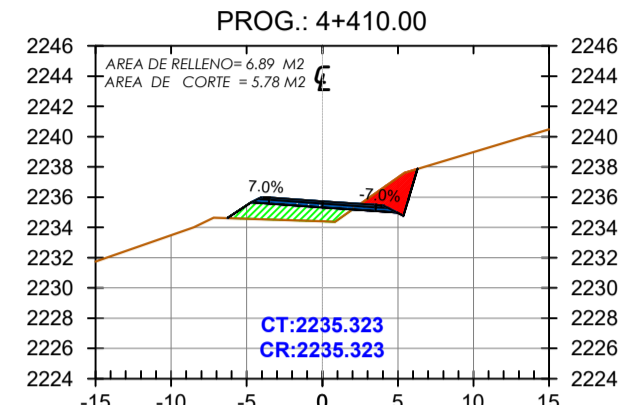
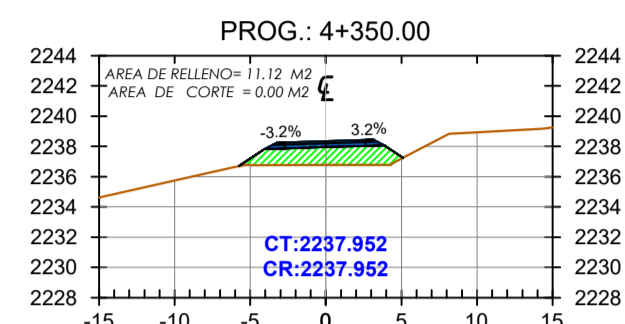
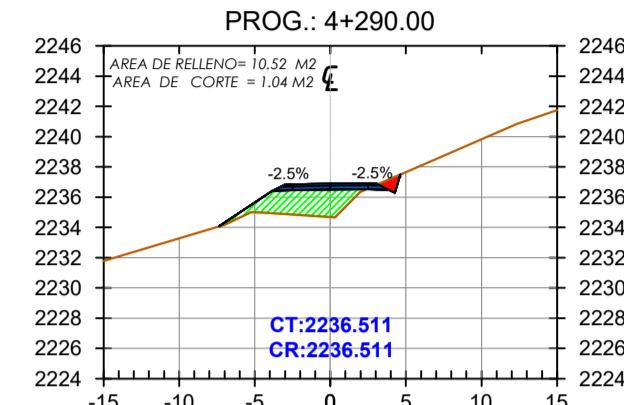
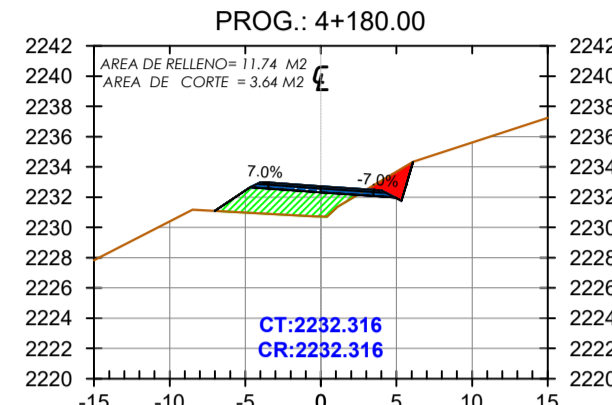
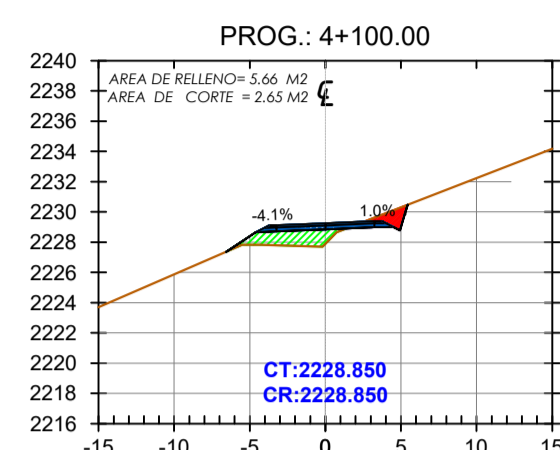

UNIVERSITARIO: BLADIMIR J. MARTINEZ MALLON
DOCENTE: MARCELO H. PACHECO NUÑES

UNIVERSIDAD AUTONOMA JUAN MISAEL SARACHO
FACULTAD DE CIENCIAS Y TECNOLOGIA
CARRERA DE INGENIERIA CIVIL
ASIGNATURA: PROYECTO DE INGENIERIA CIVIL II CIV-502



Proyecto: DISEÑO DE INGENIERIA TRAMO CARLAZO CENTRO - CARLAZO ESTE

Revisión:

Título: SECCIONES TRANSVERSALES
Escala: 1:500
Nº de Lámina: 05/09

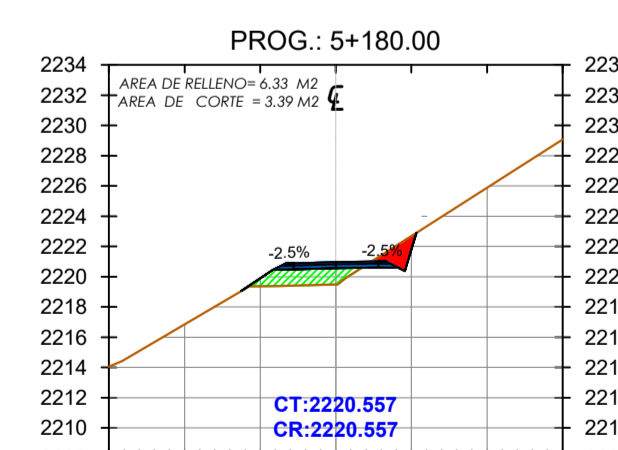
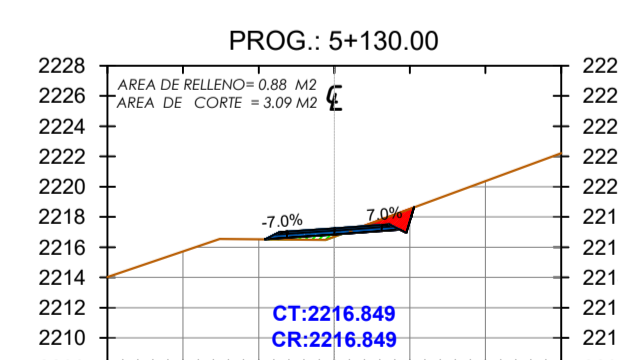
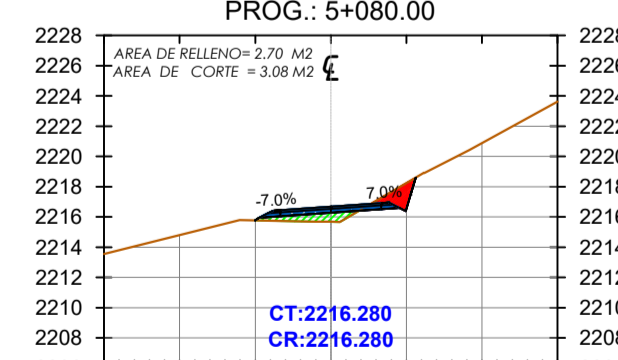
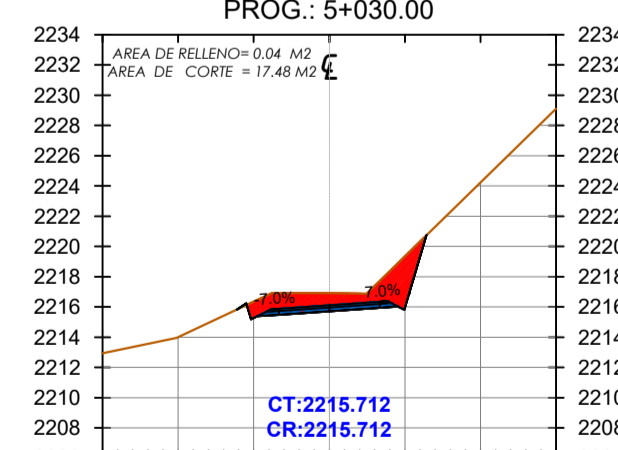
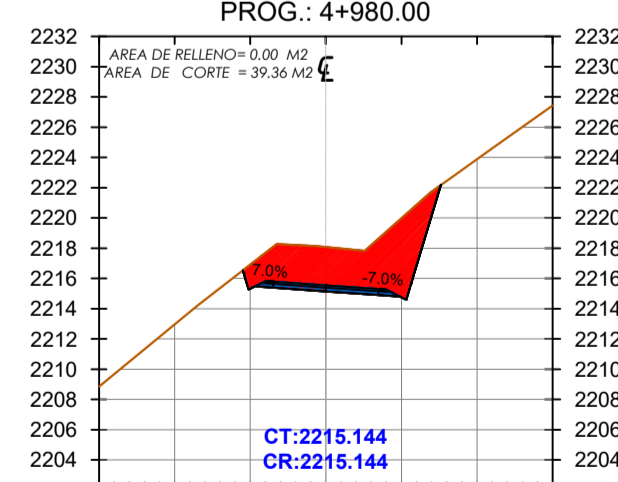
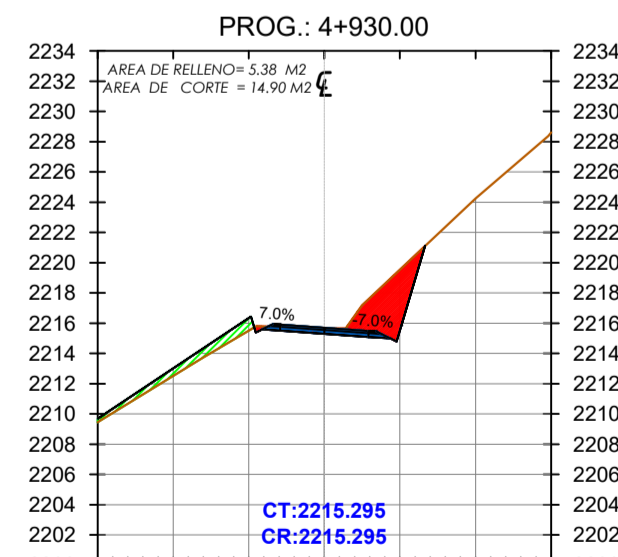
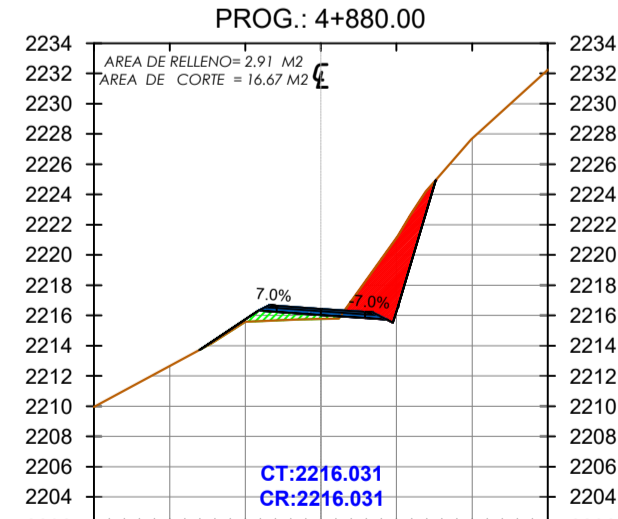
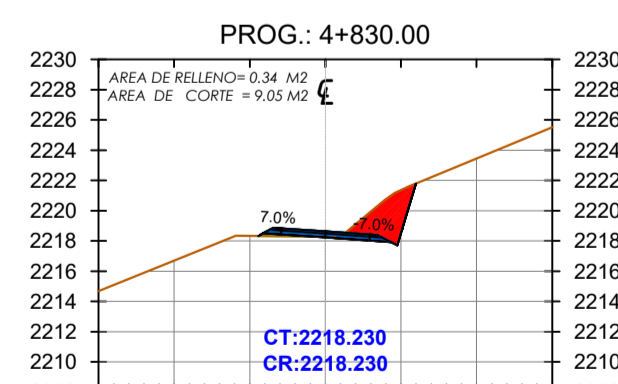
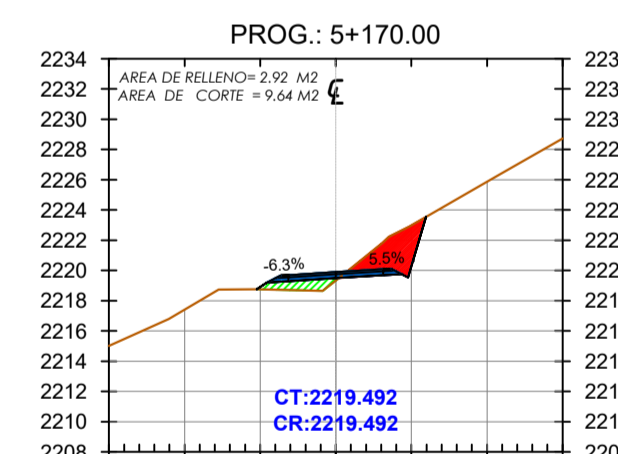
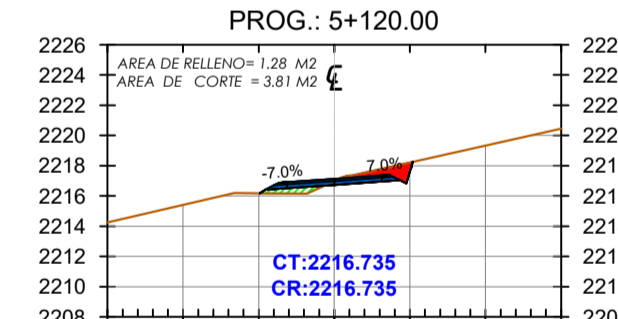
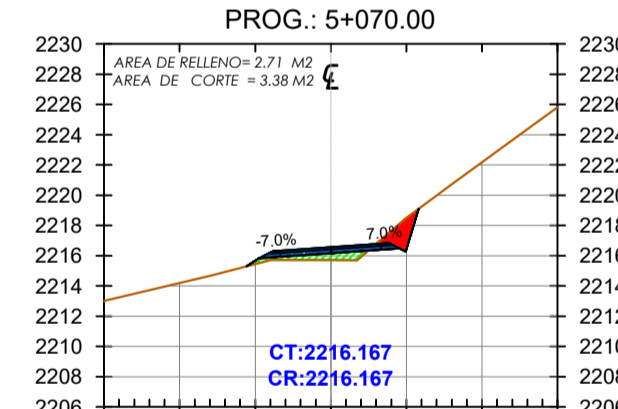
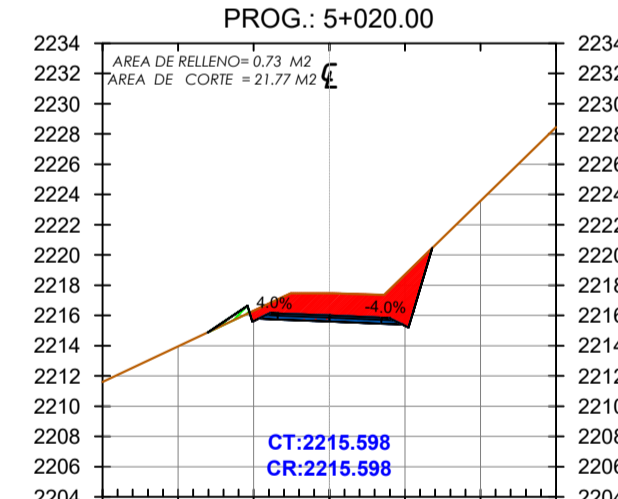
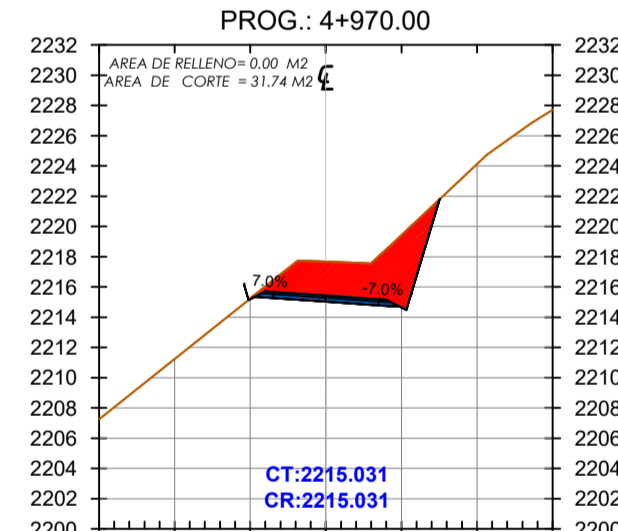
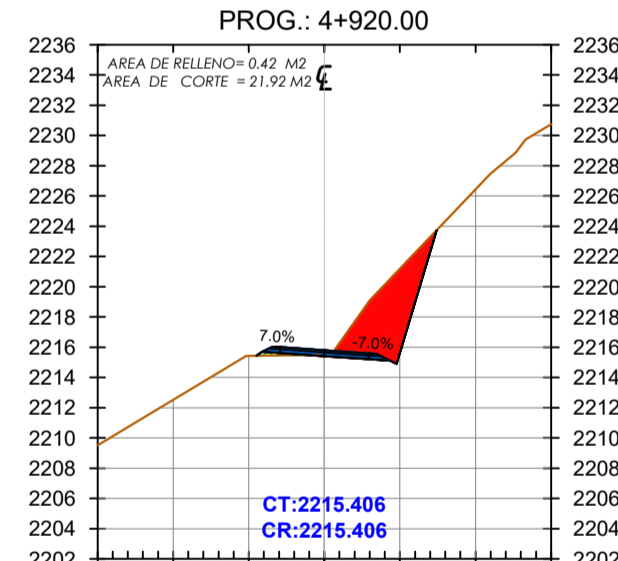
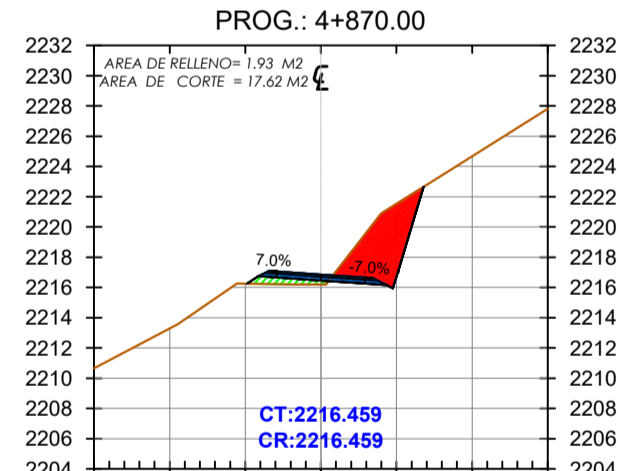
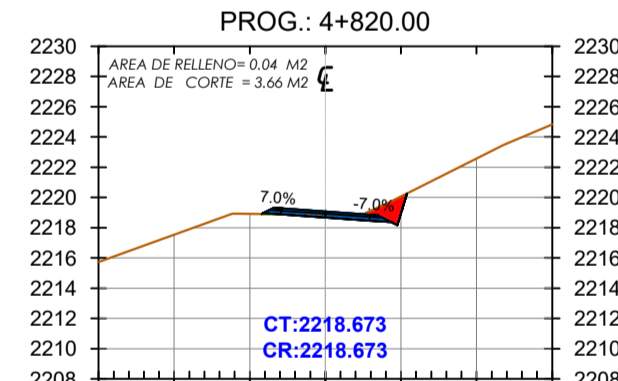
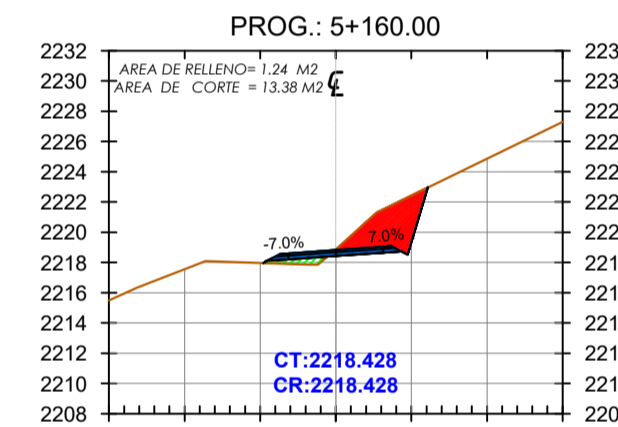
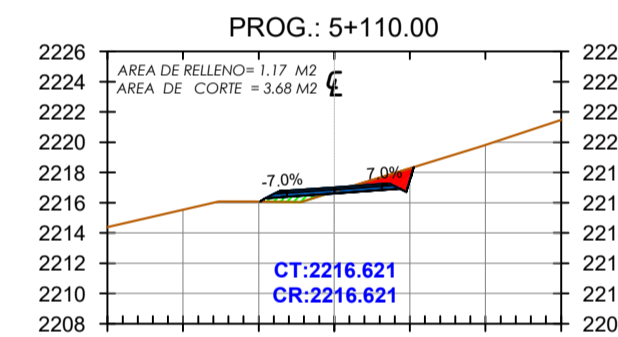
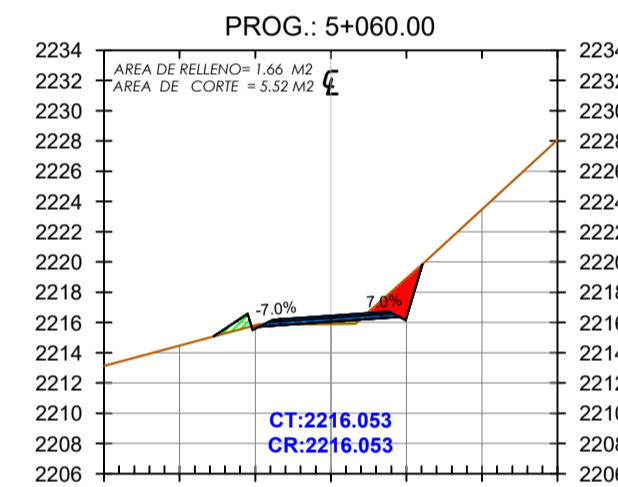
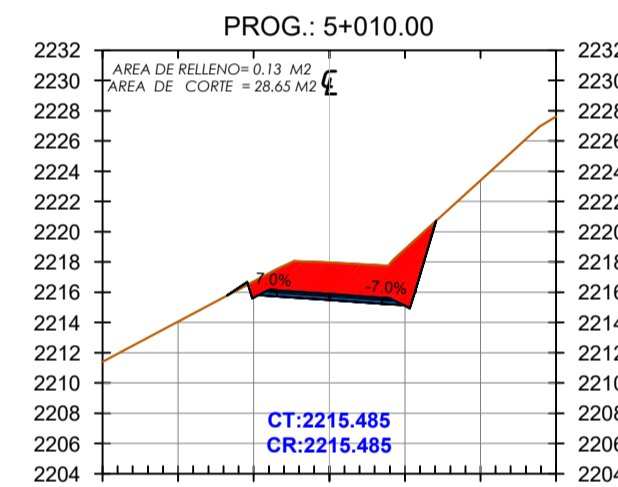
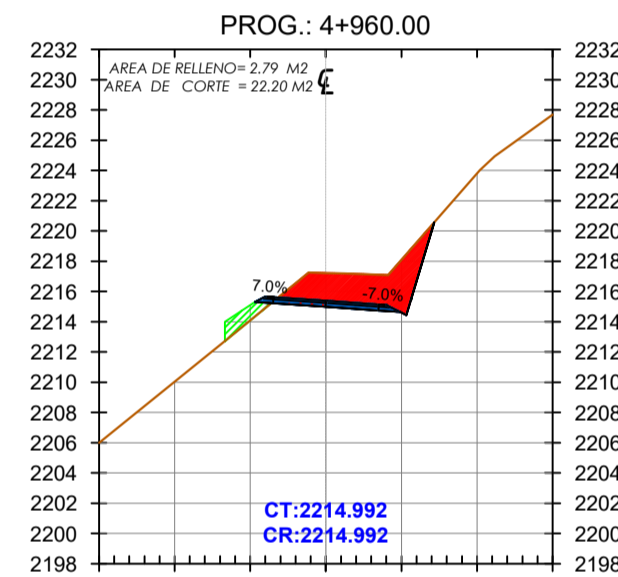
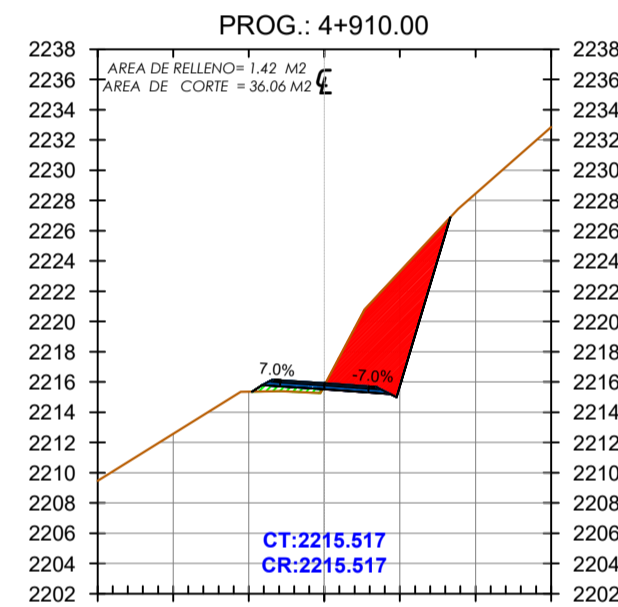
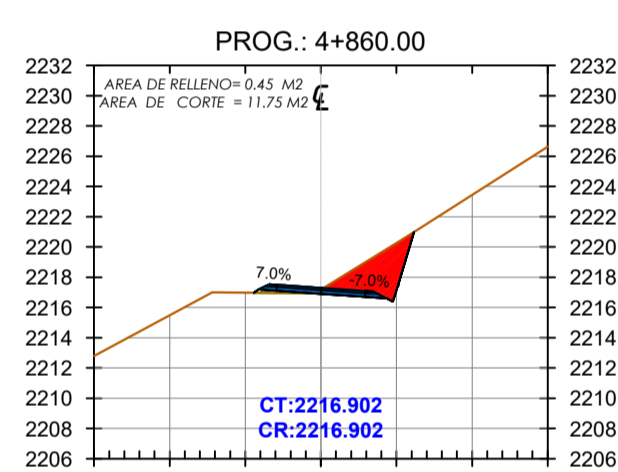
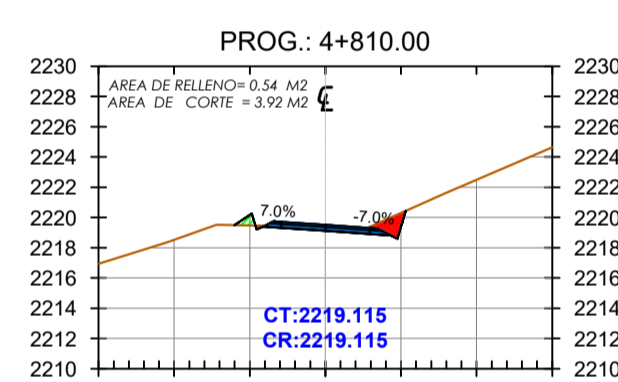
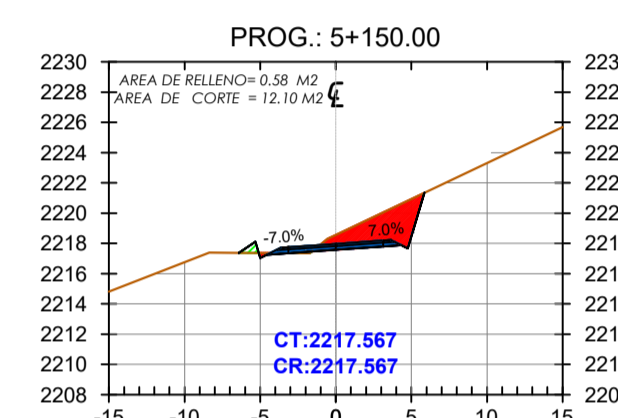
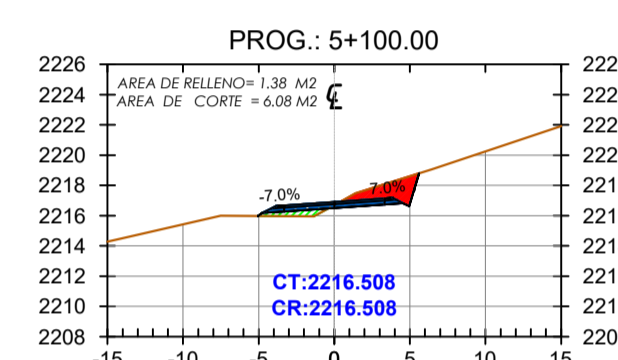
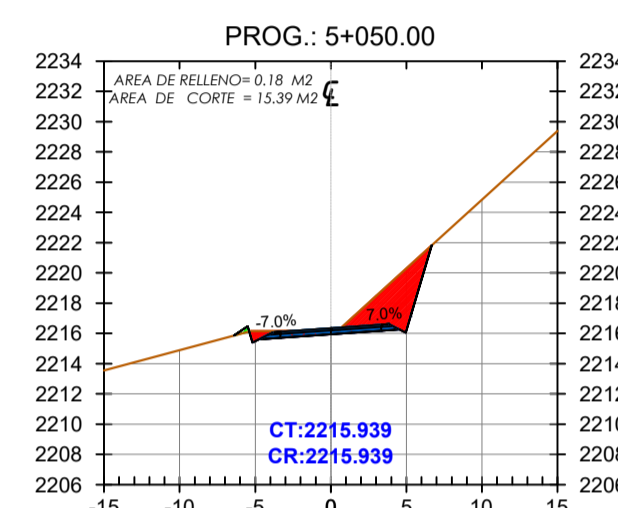
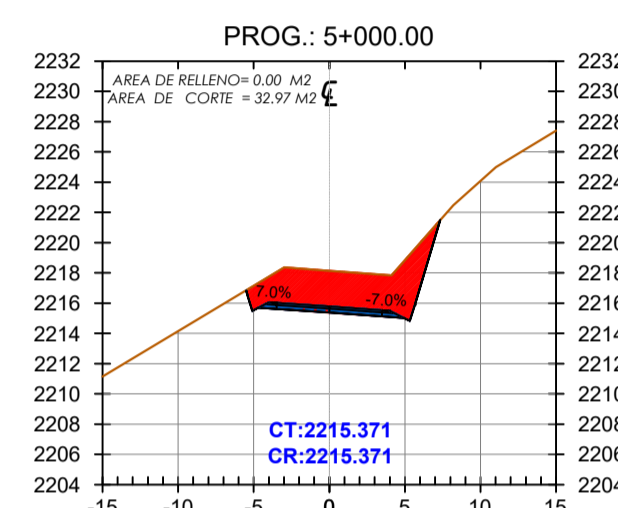
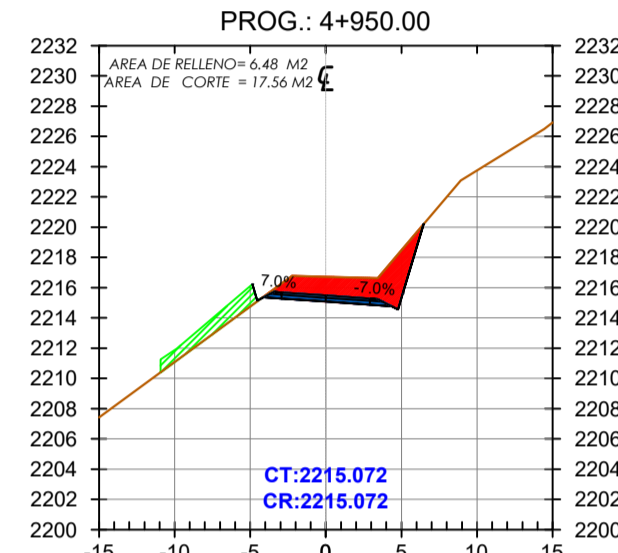
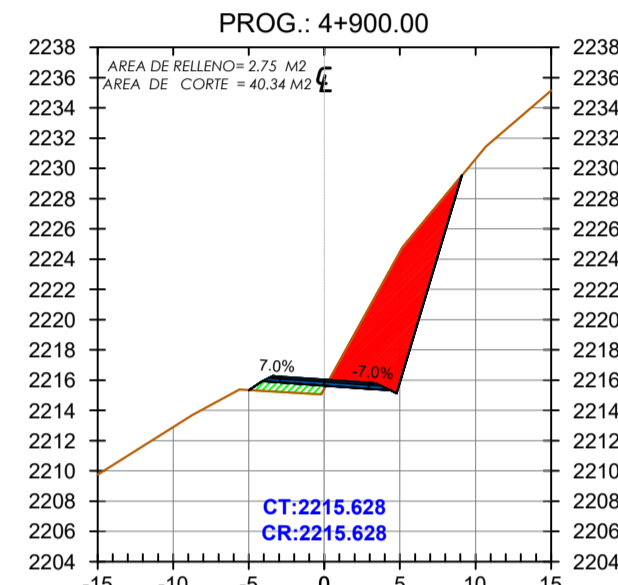
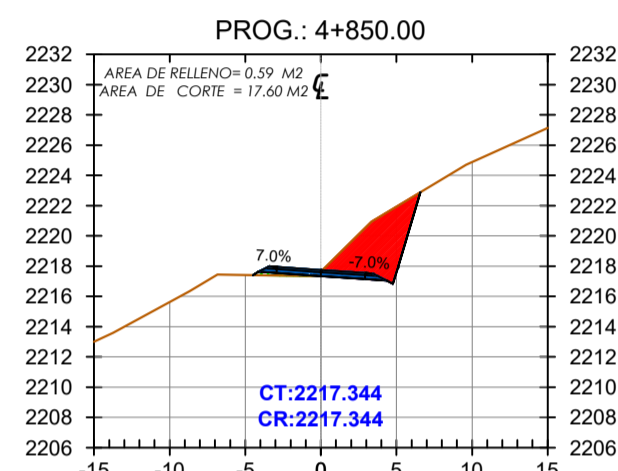
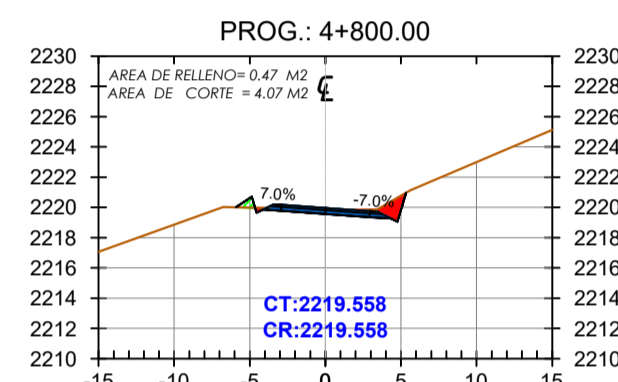
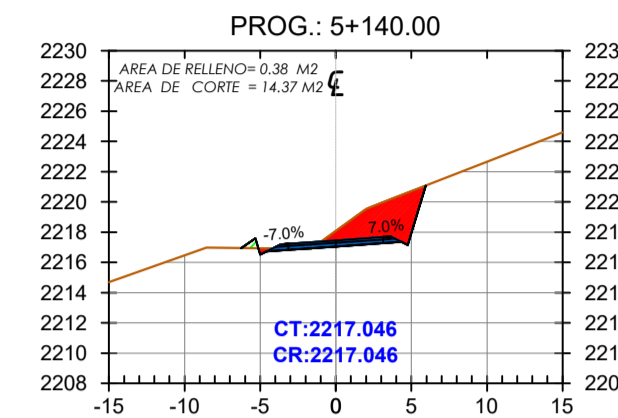
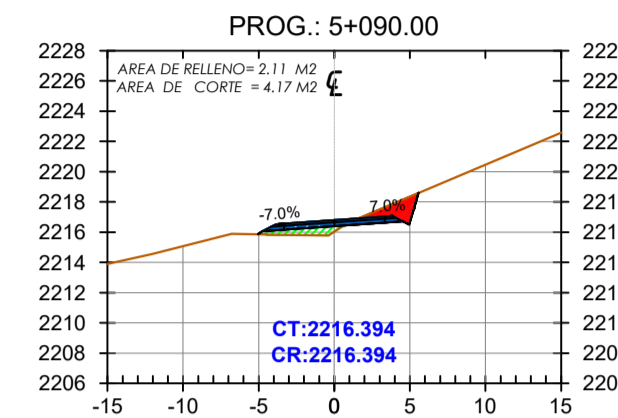
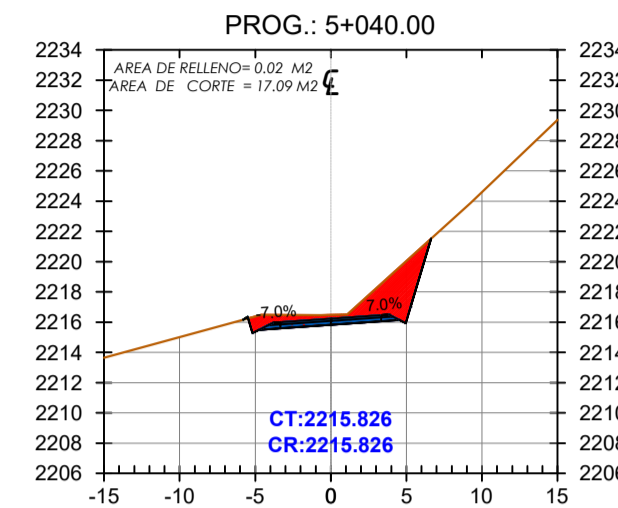
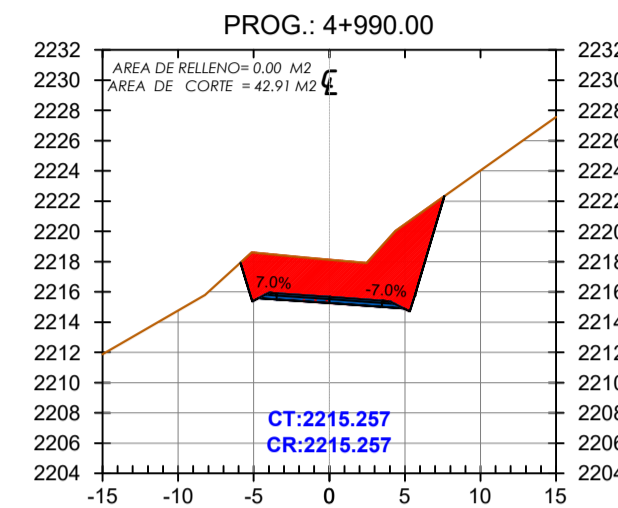
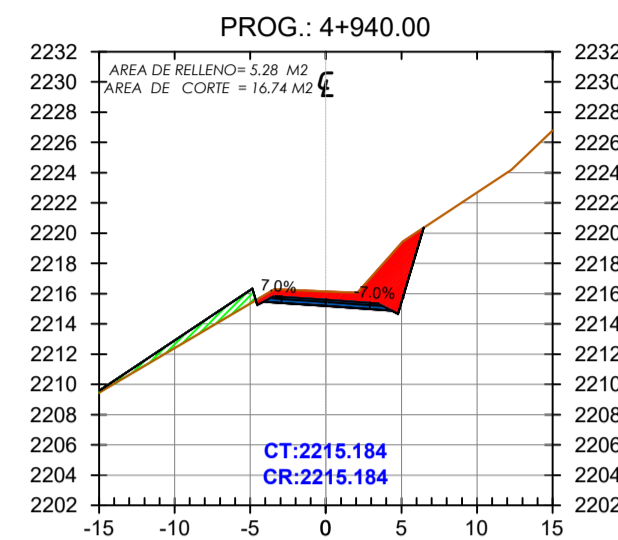
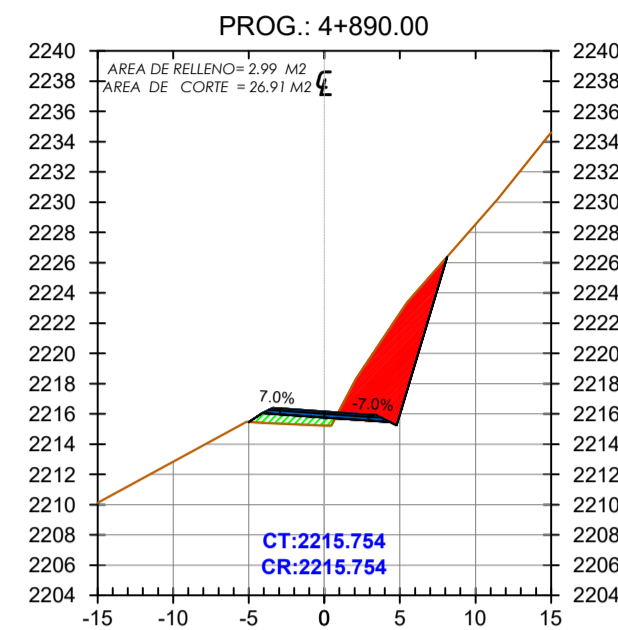
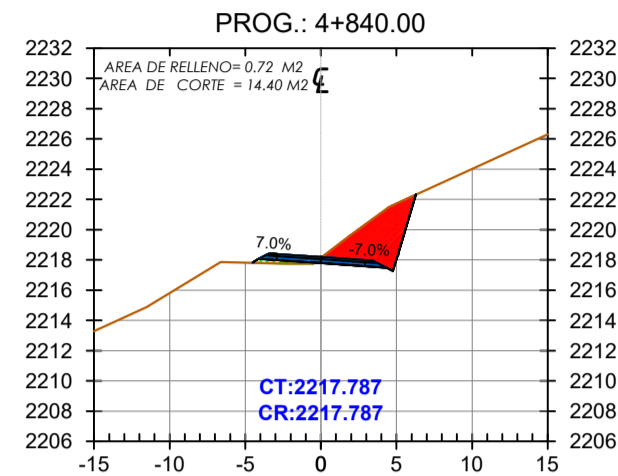
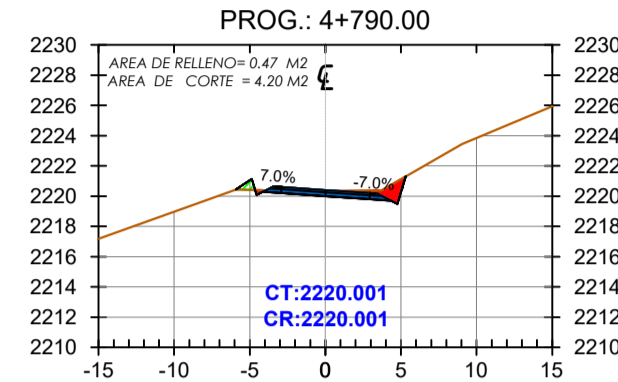

UNIVERSITARIO: BLADIMIR J. MARTINEZ MALLON

DOCENTE: MARCELO H. PACHECO NUÑES

UNIVERSIDAD AUTONOMA JUAN MISAEL SARACHO
 FACULTAD DE CIENCIAS Y TECNOLOGIA
 CARRERA DE INGENIERIA CIVIL
 ASIGNATURA: PROYECTO DE INGENIERIA CIVIL II CIV-502



Proyecto:

DISEÑO DE INGENIERIA TRAMO CARLAZO CENTRO - CARLAZO ESTE

Revisión:

Título: SECCIONES TRANSVERSALES

Progresivas: De: 4+790 A: 5+180	Nº de Lámina: 06/09
Escala: 1:500	

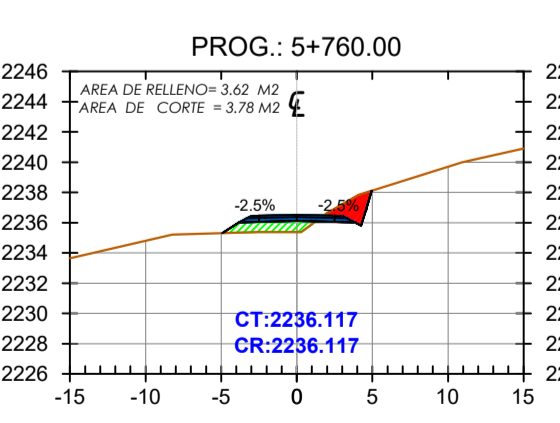
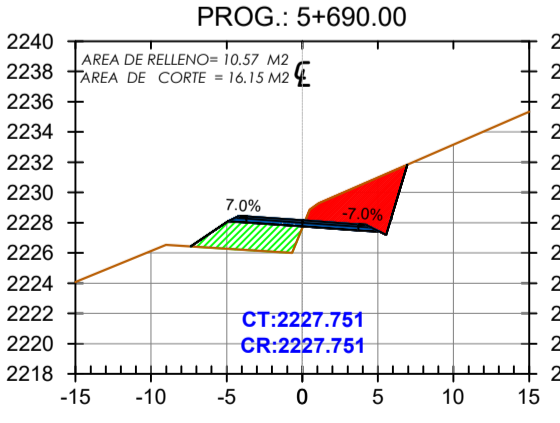
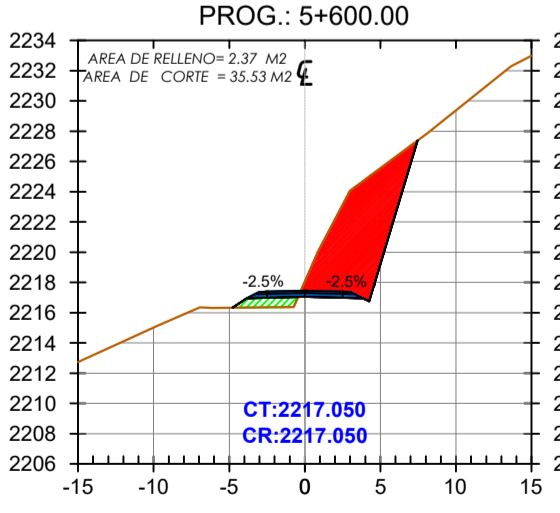
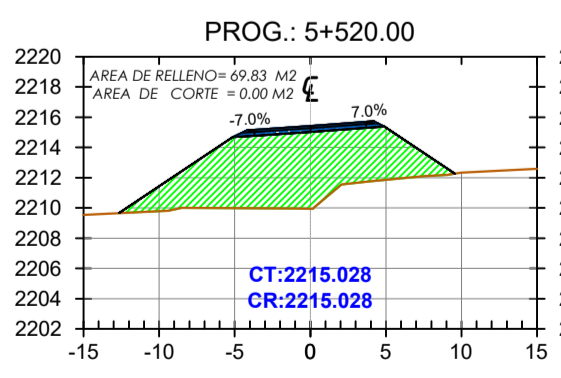
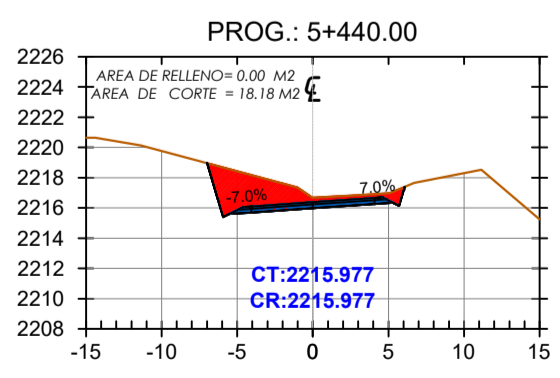
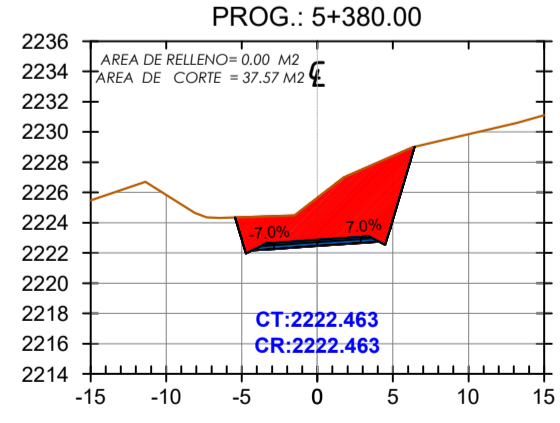
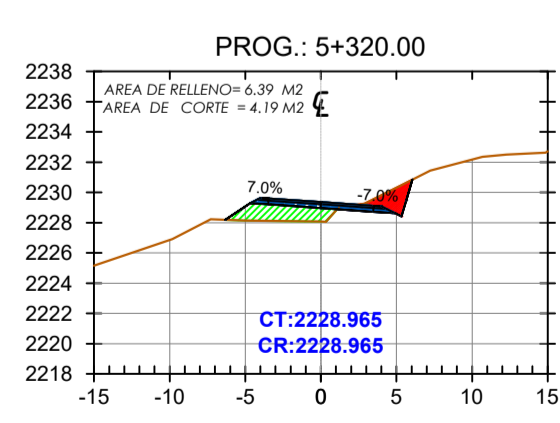
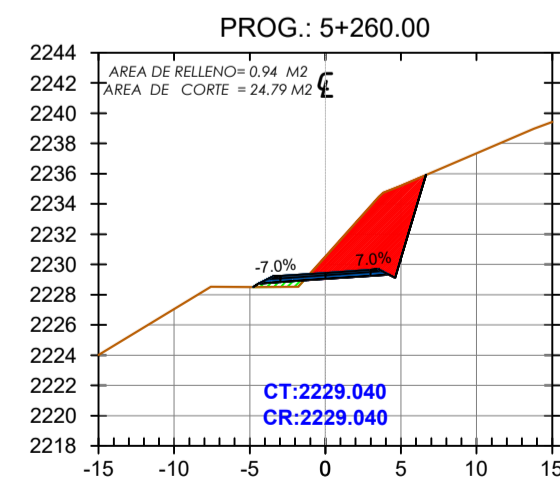
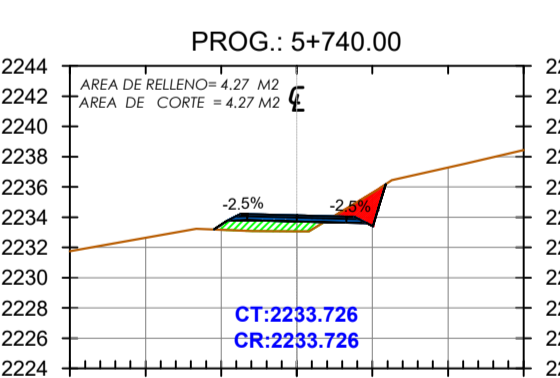
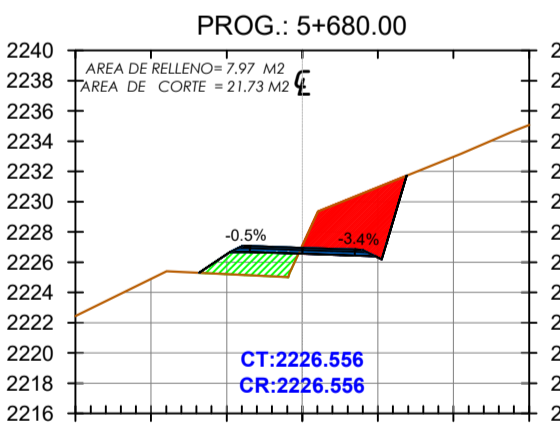
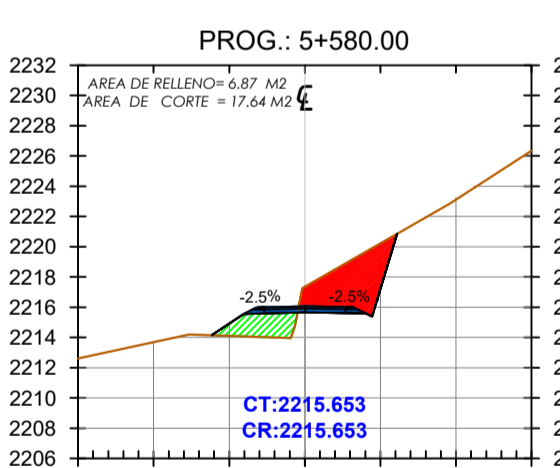
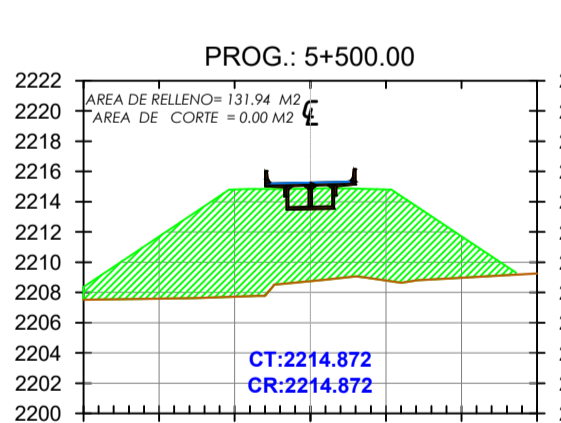
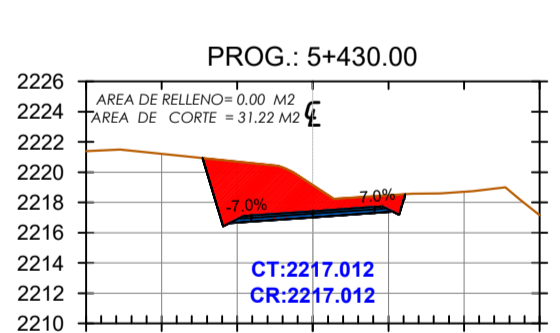
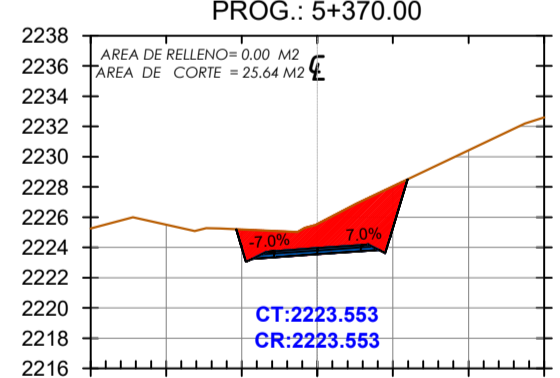
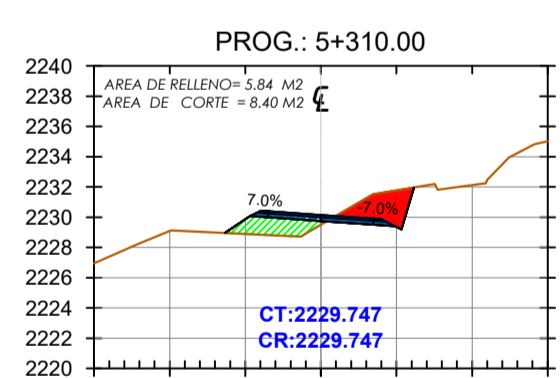
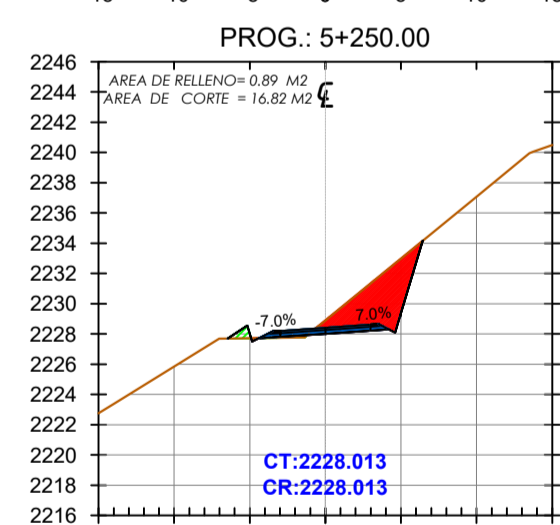
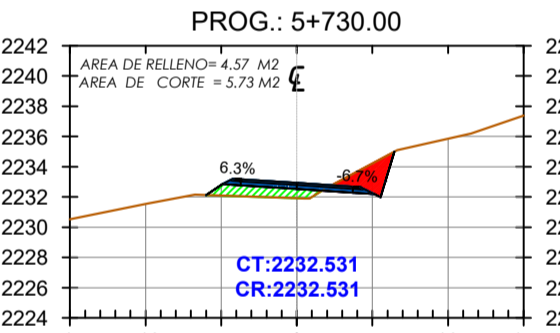
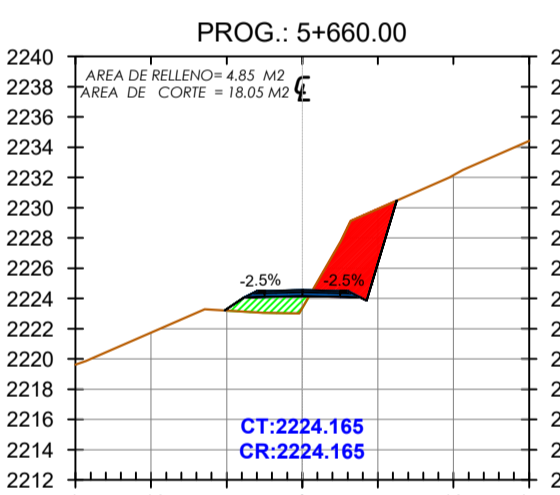
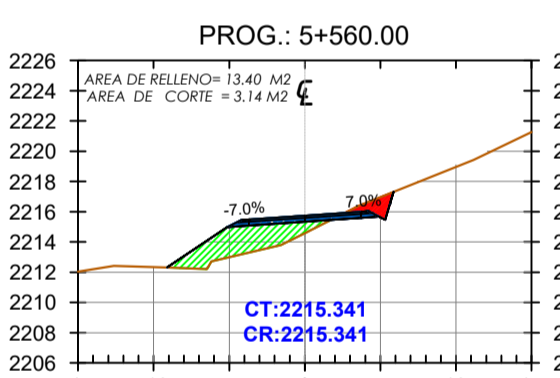
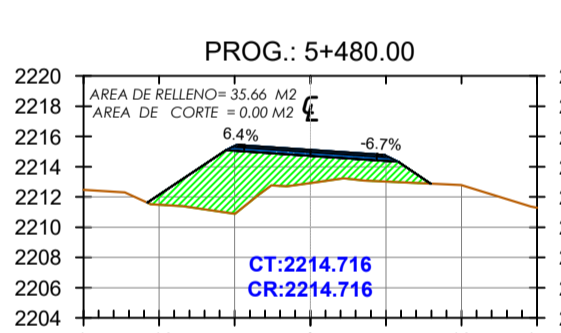
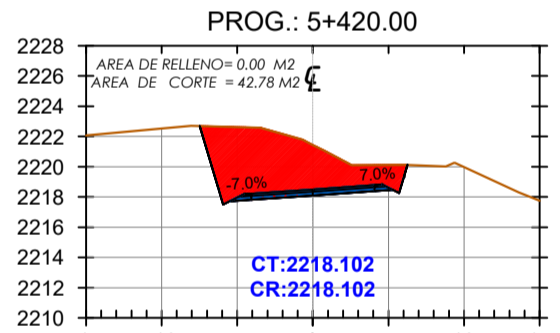
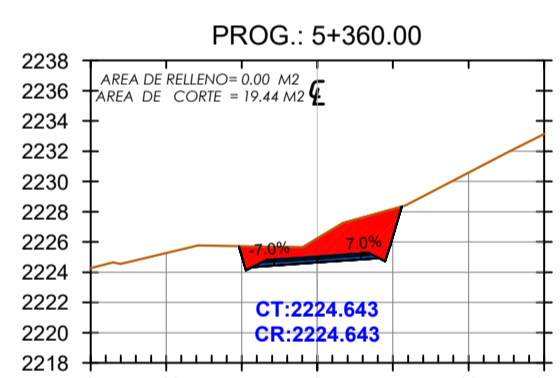
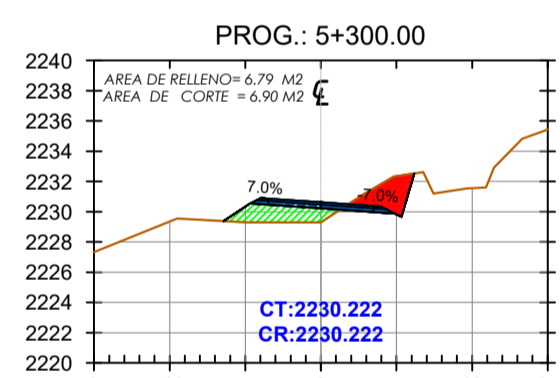
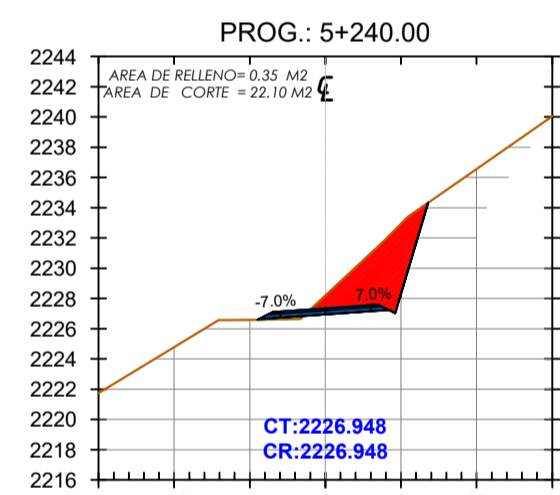
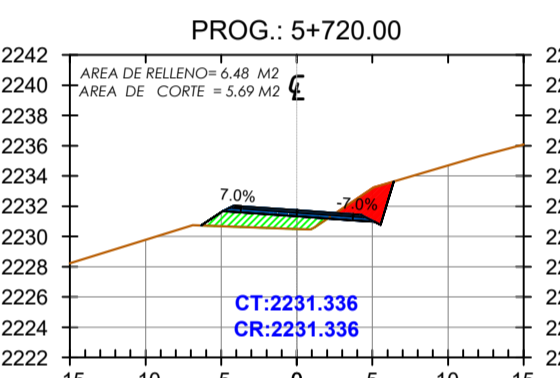
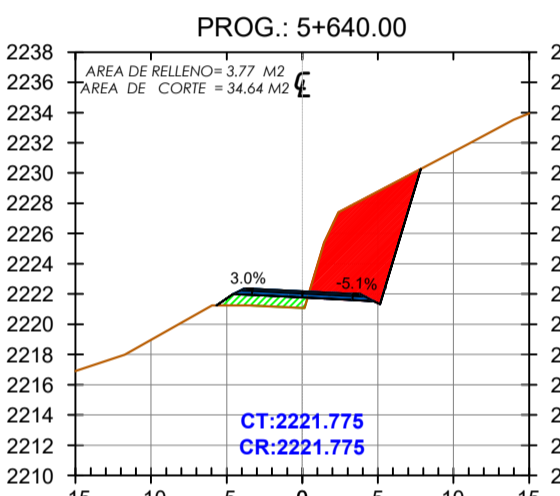
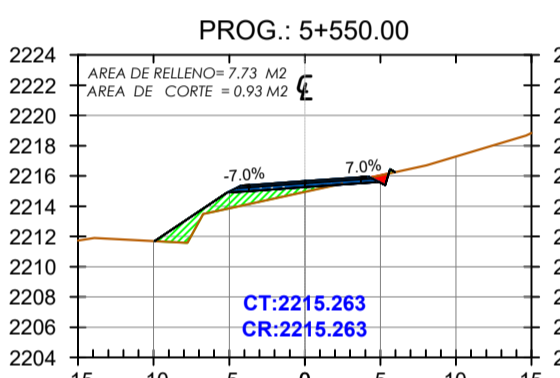
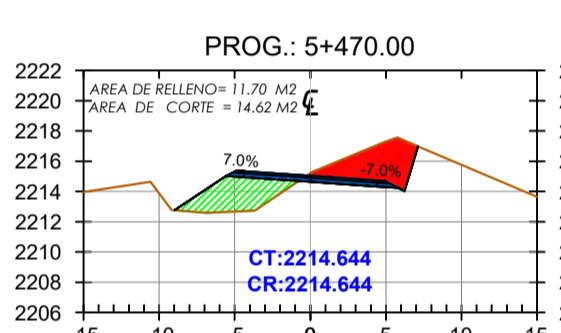
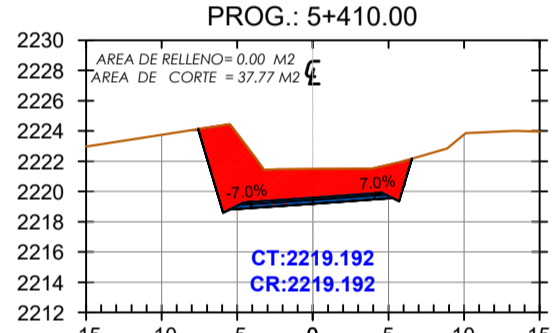
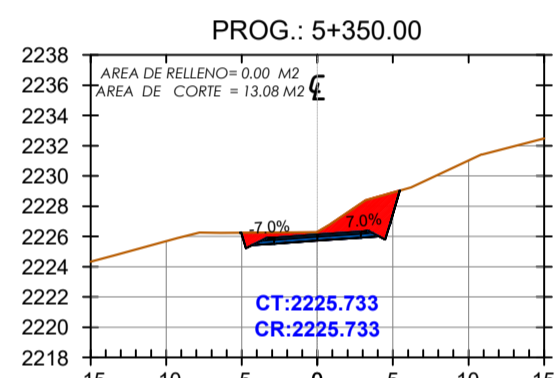
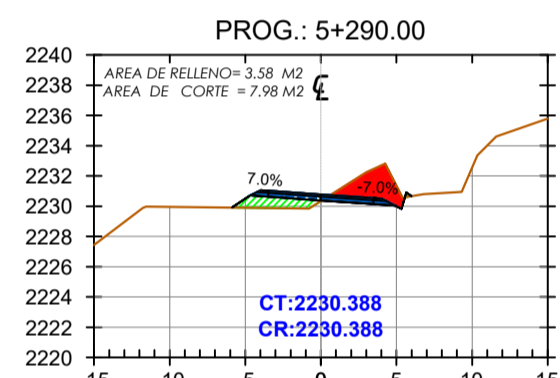
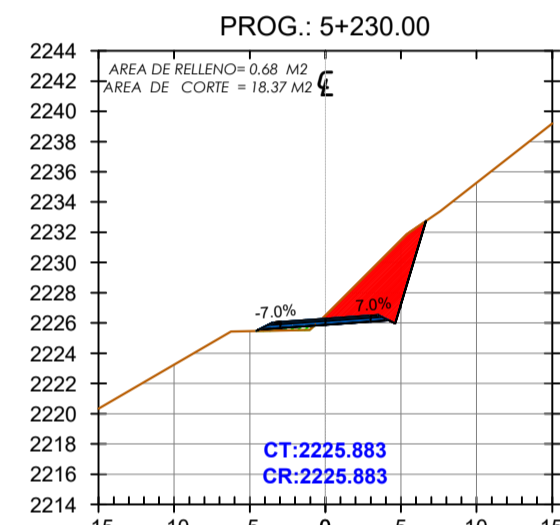
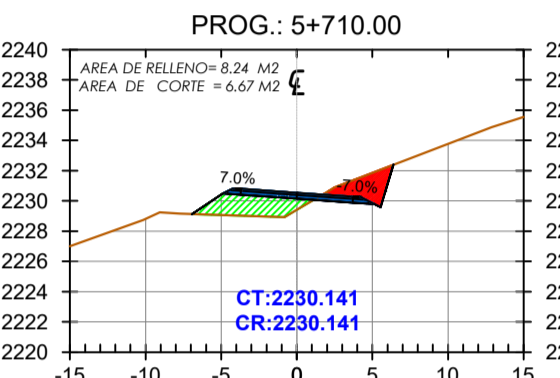
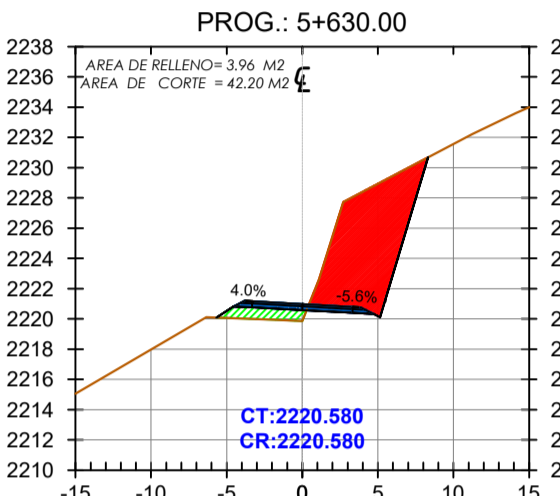
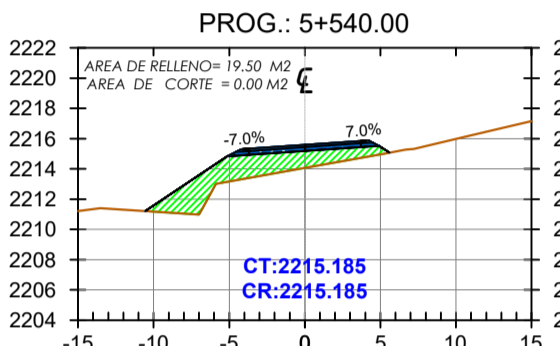
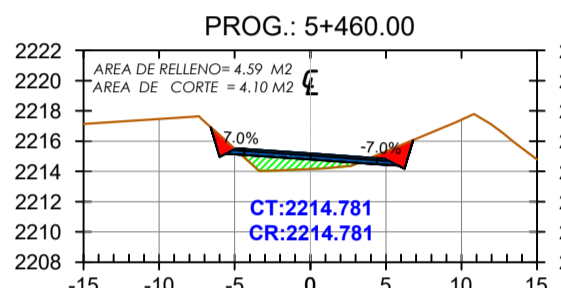
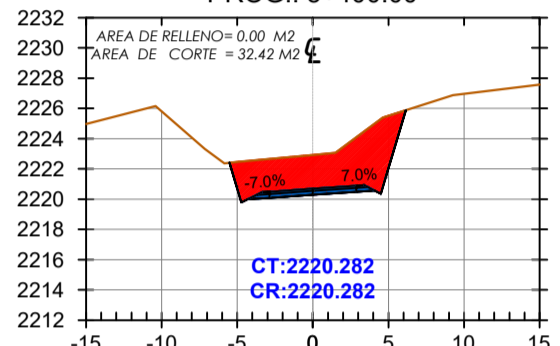
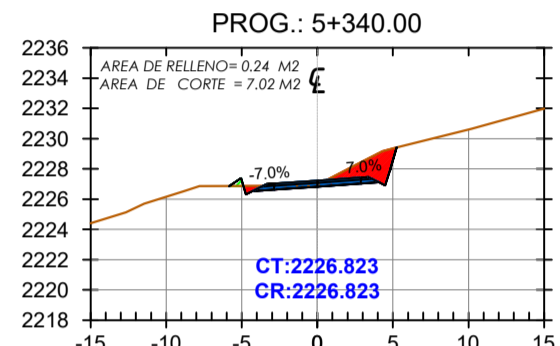
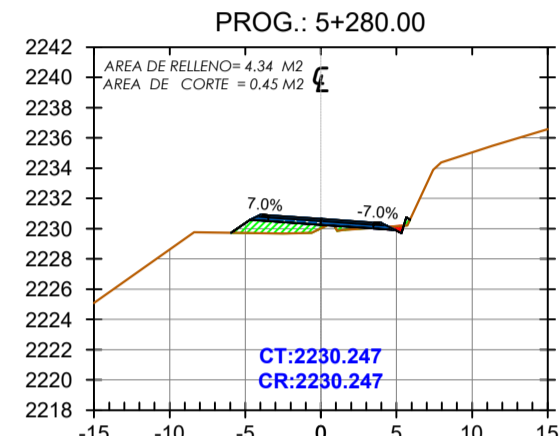
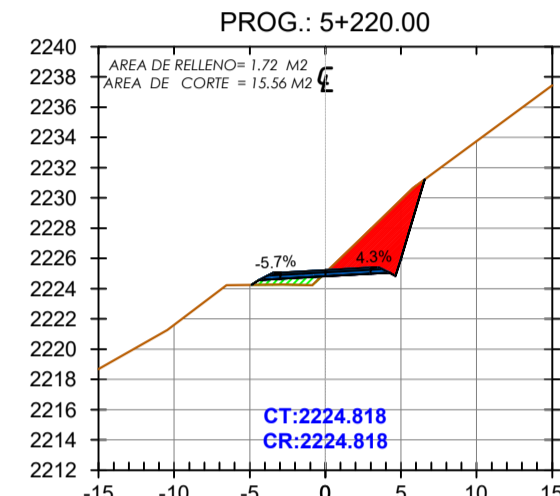
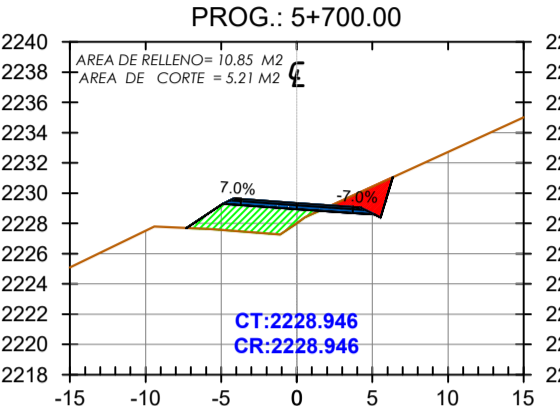
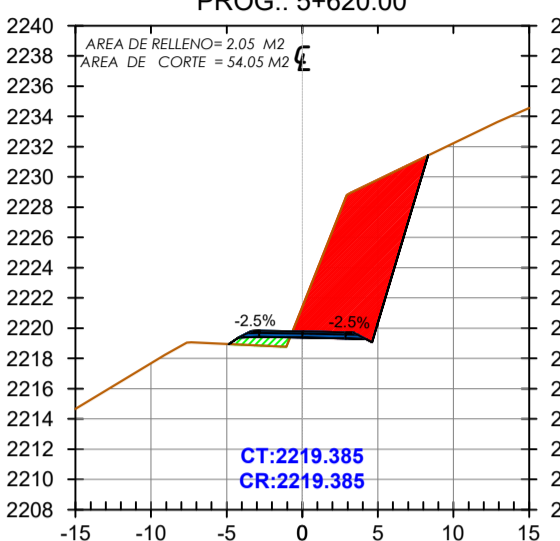
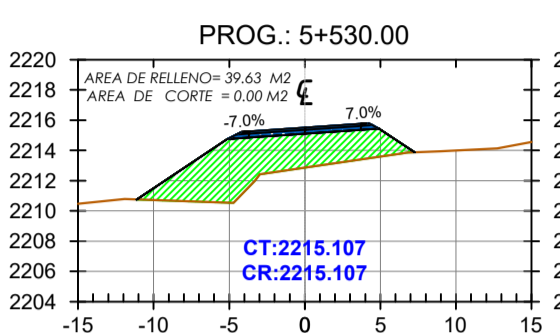
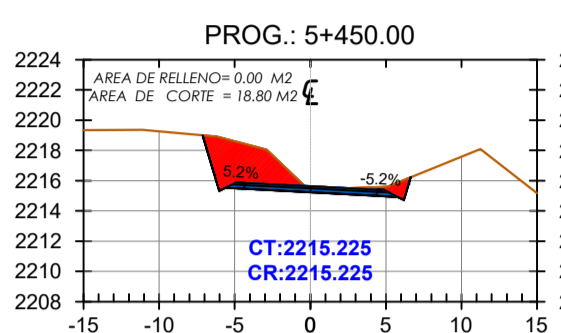
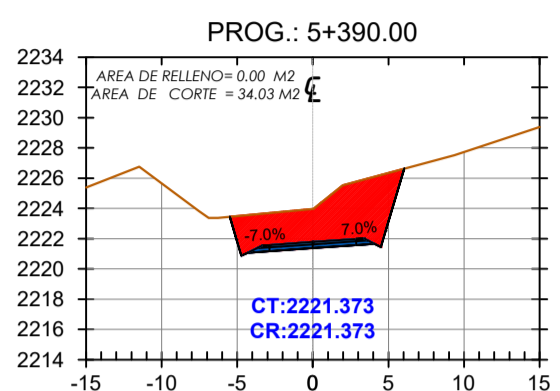
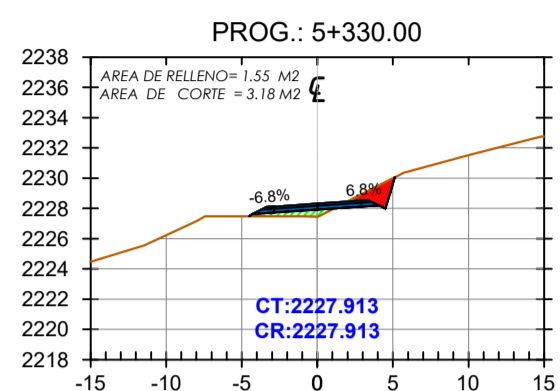
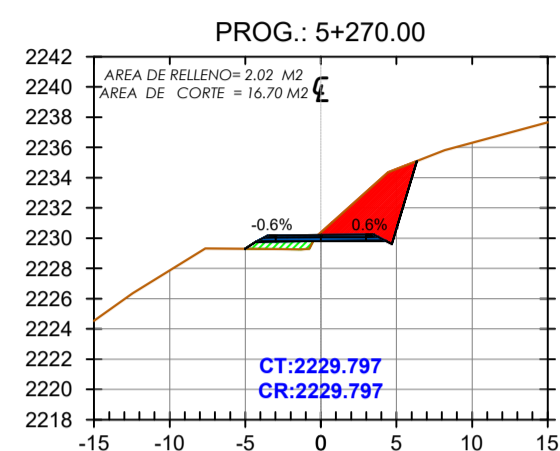
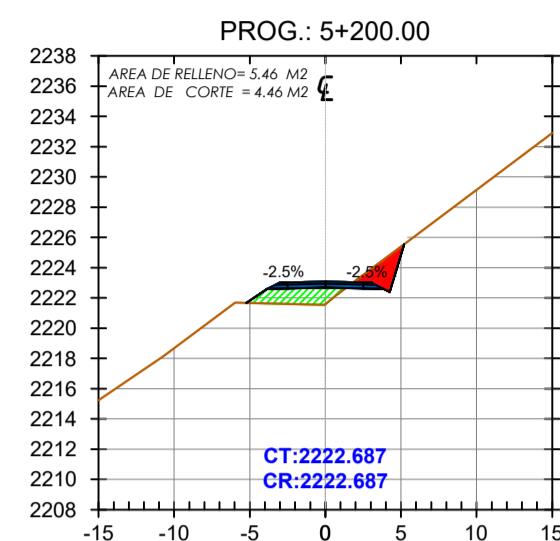

UNIVERSITARIO: BLADIMIR J. MARTINEZ MALLON

DOCENTE: MARCELO H. PACHECO NUÑES

UNIVERSIDAD AUTONOMA JUAN MISAEL SARACHO
 FACULTAD DE CIENCIAS Y TECNOLOGIA
 CARRERA DE INGENIERIA CIVIL
 ASIGNATURA: PROYECTO DE INGENIERIA CIVIL II CIV-502



Proyecto:

DISEÑO DE INGENIERIA TRAMO CARLAZO CENTRO - CARLAZO ESTE

Revisión:

Título: SECCIONES TRANSVERSALES

Escalas: 1:500
 Progresivas: De: 5+200 A: 5+760
 Nº de Lámina: 07/09

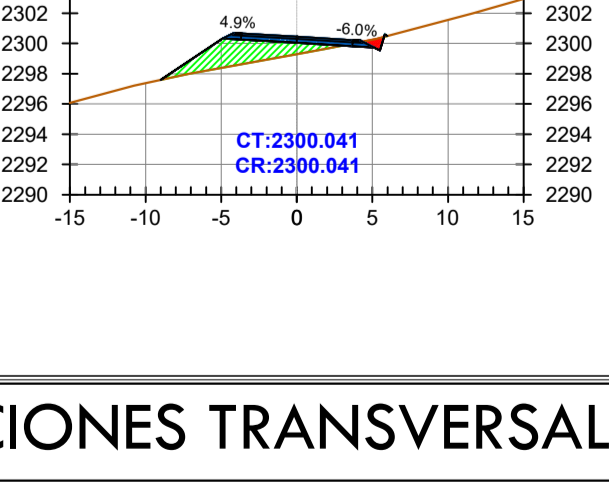
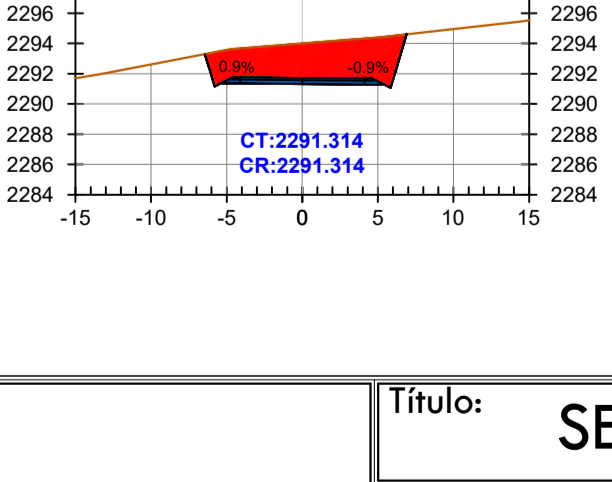
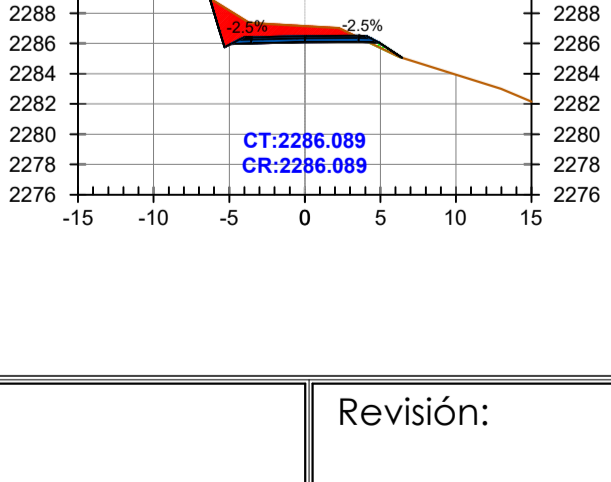
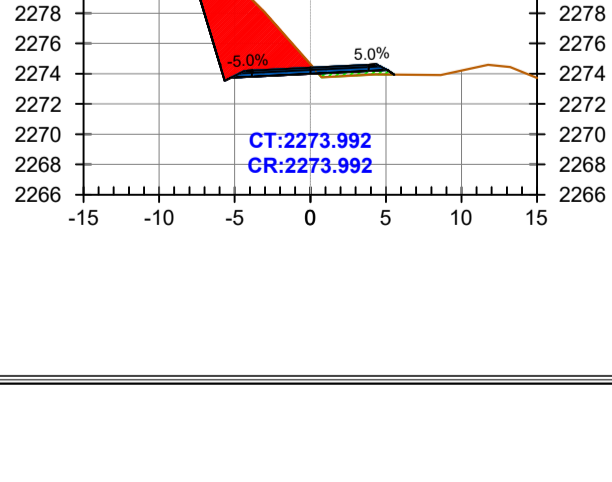
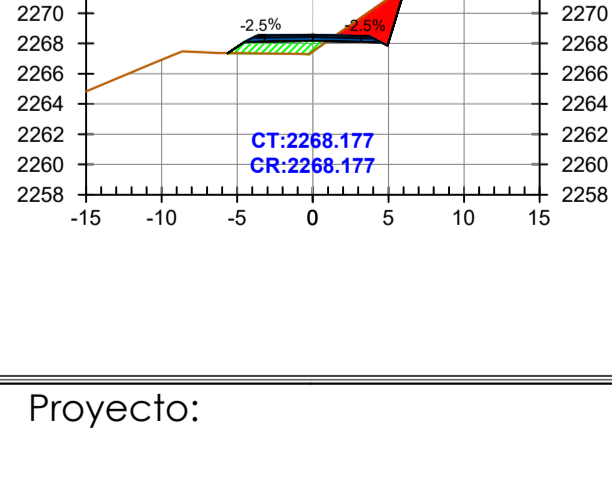
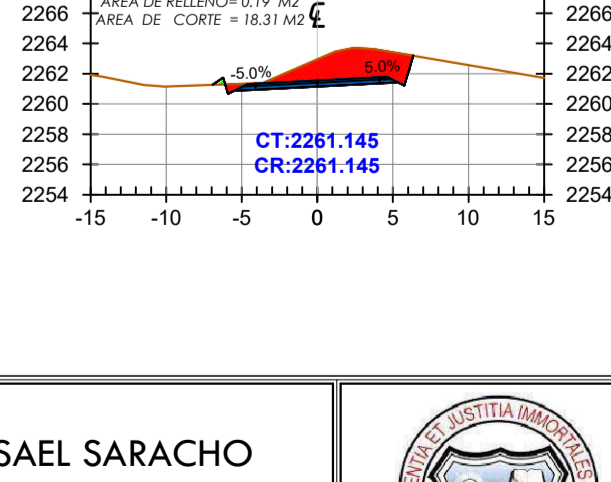
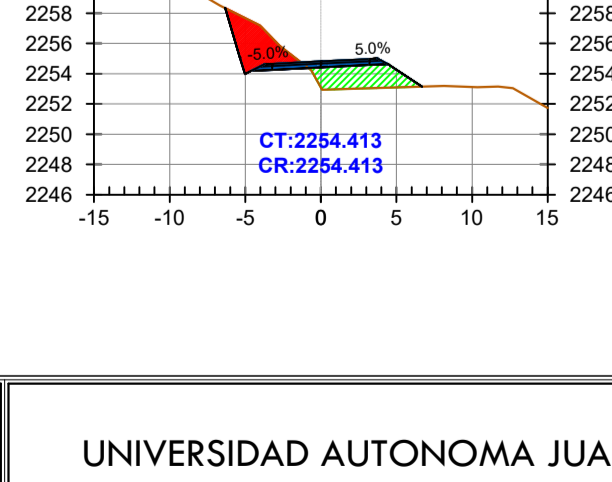
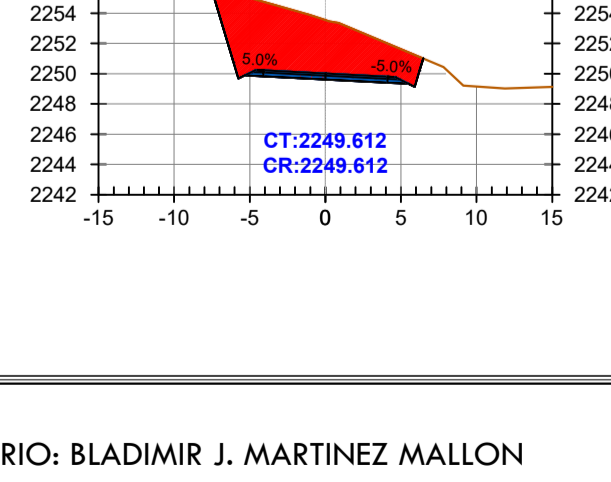
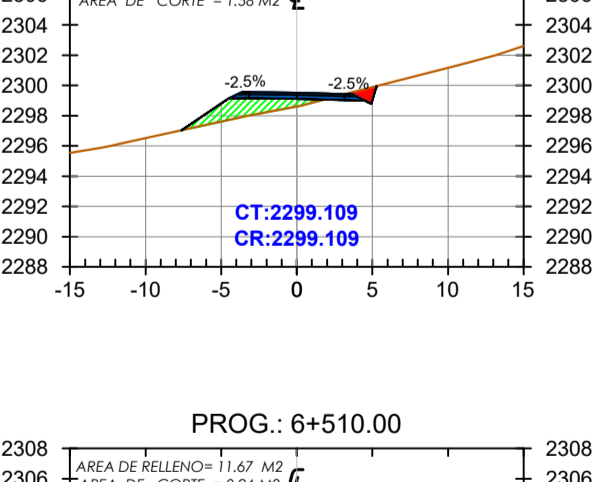
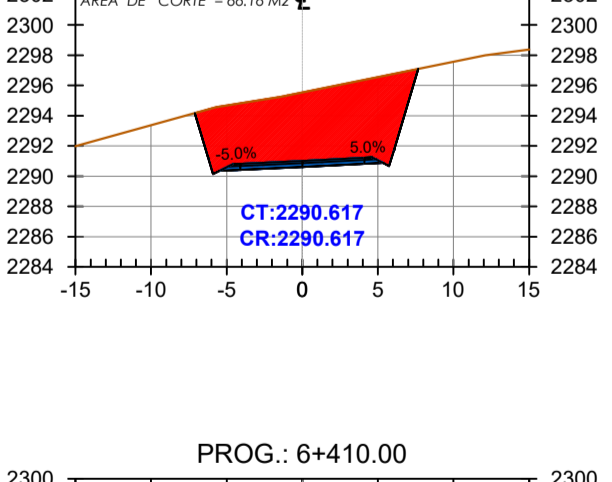
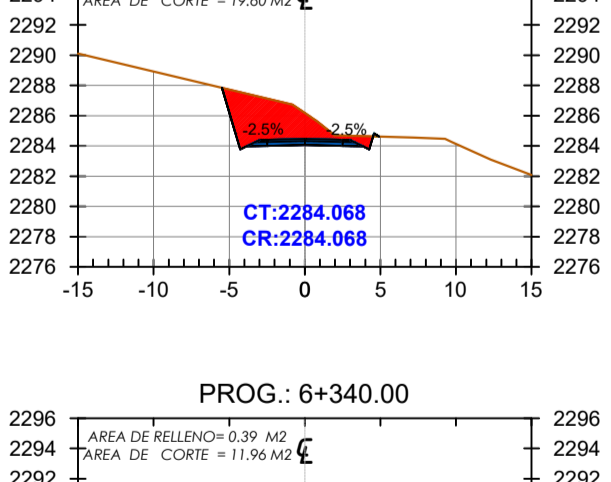
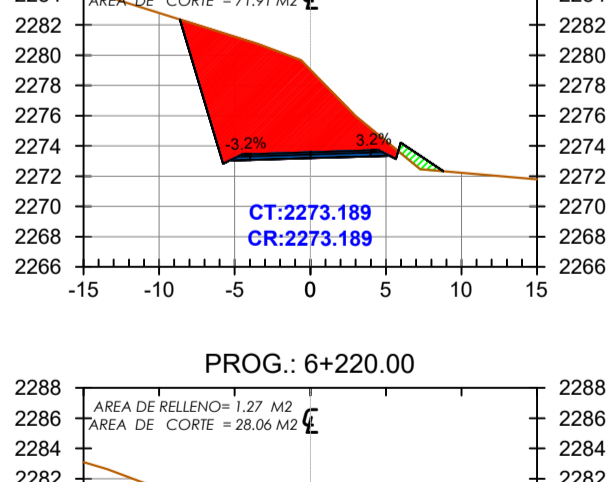
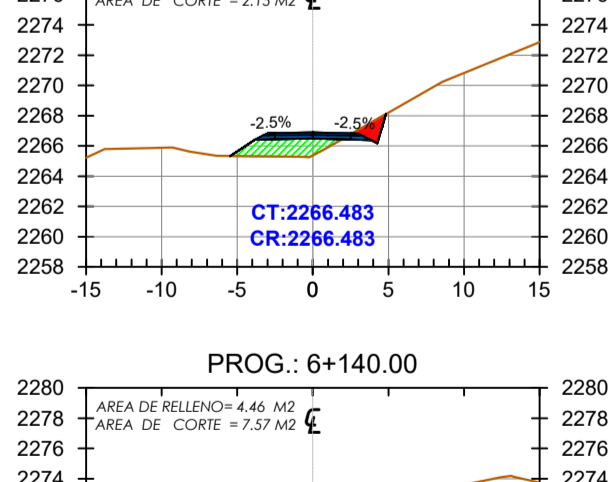
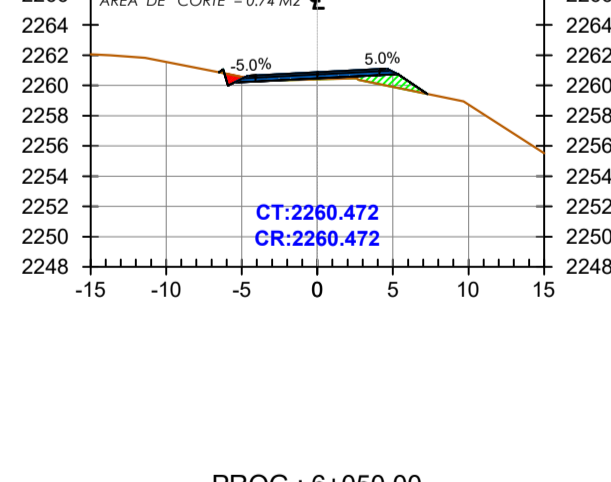
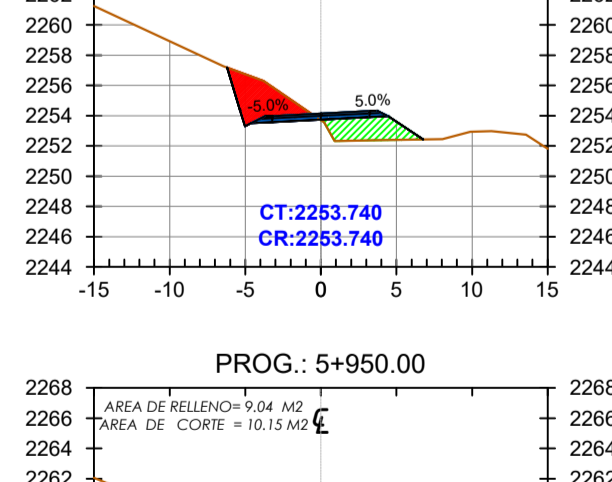
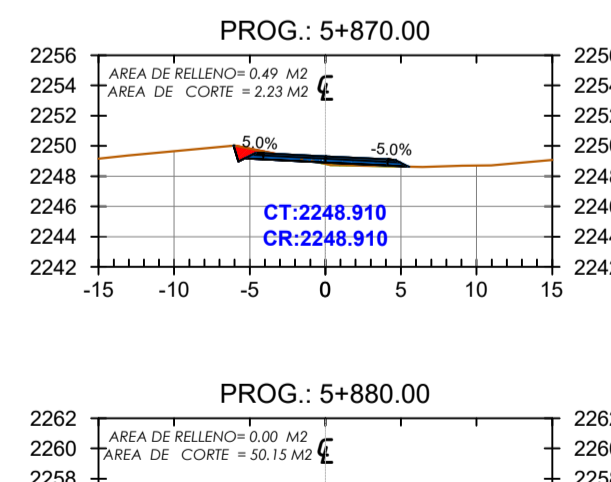
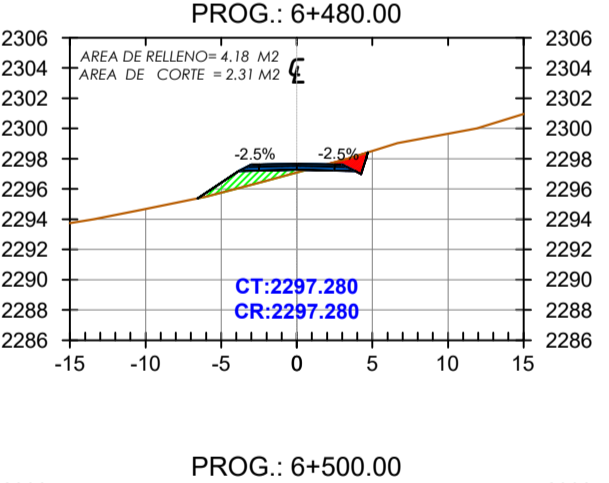
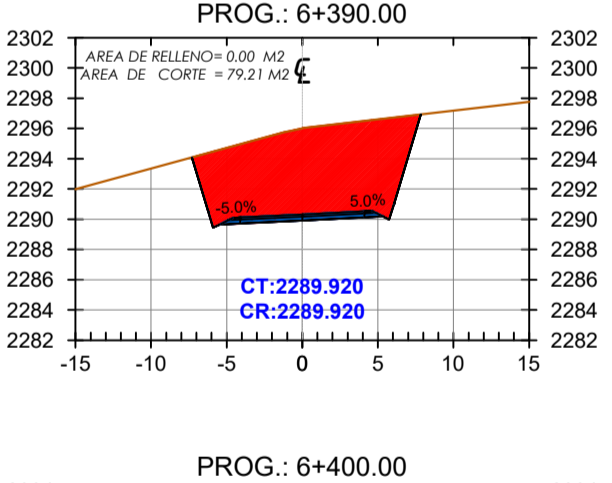
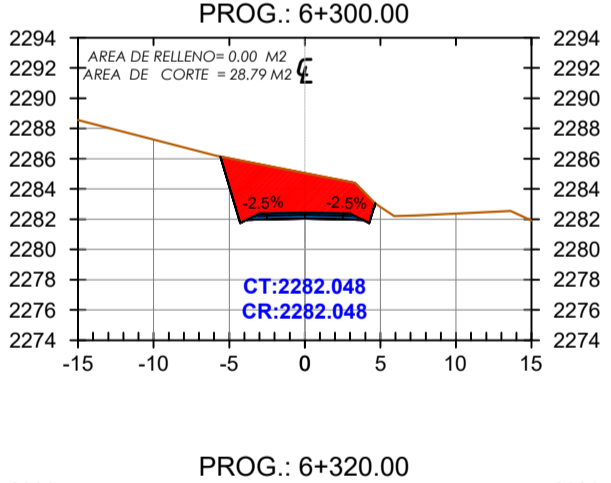
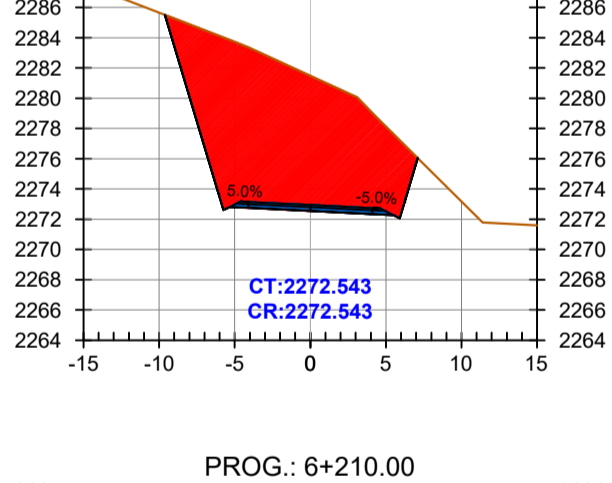
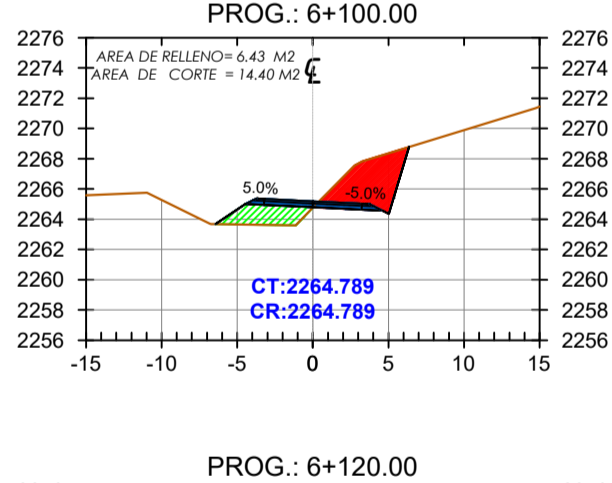
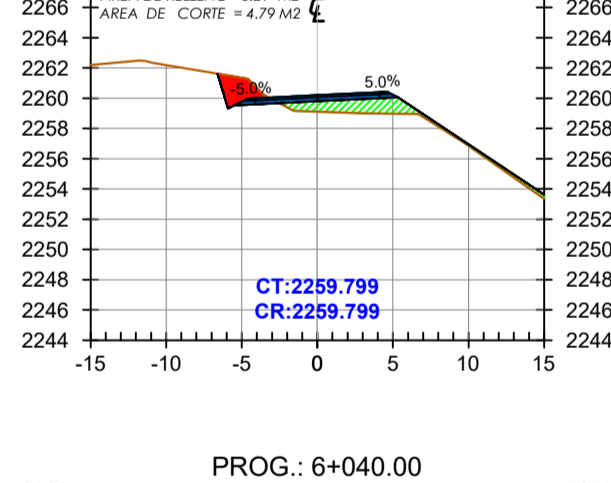
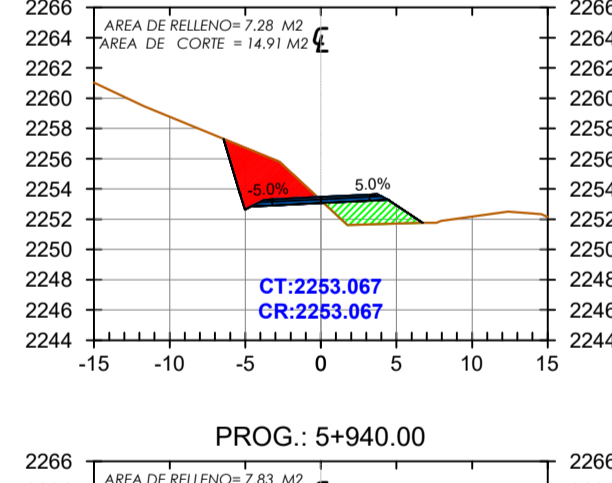
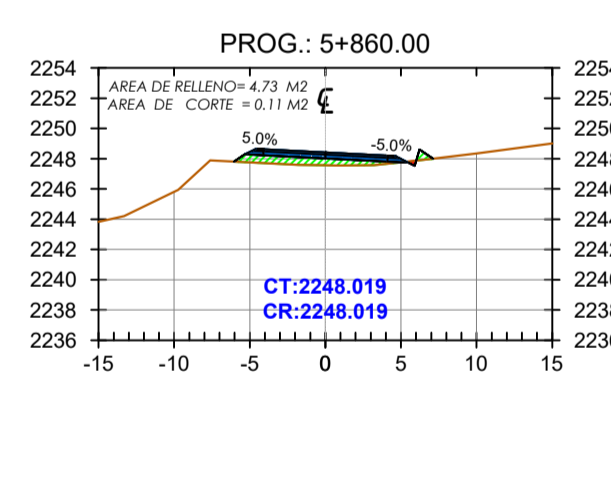
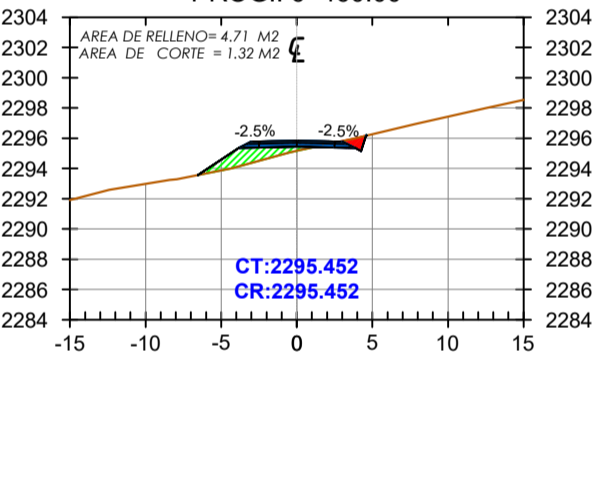
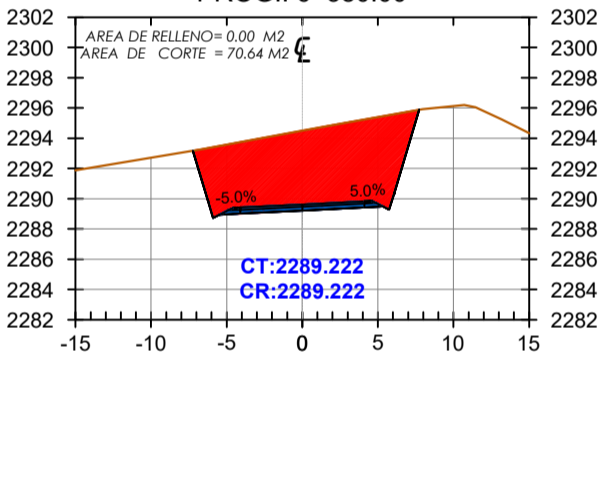
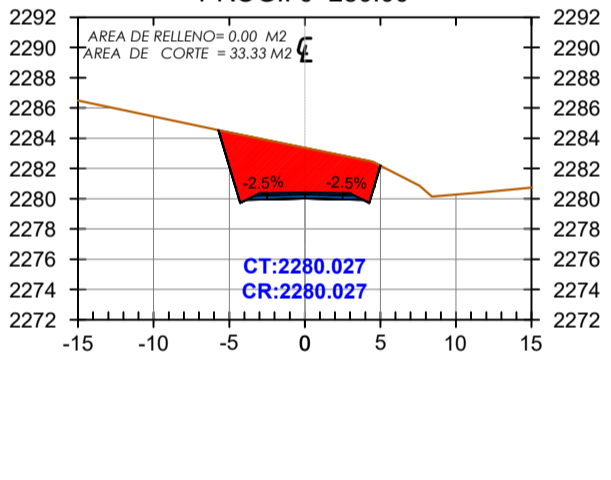
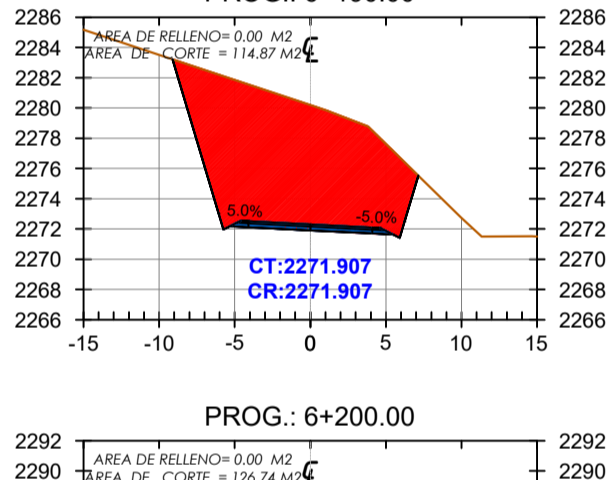
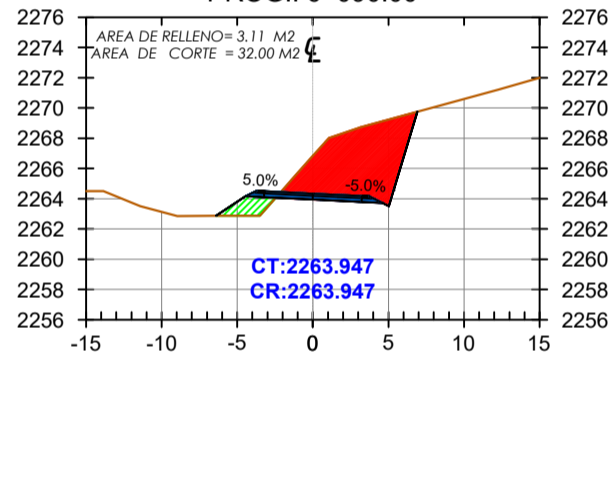
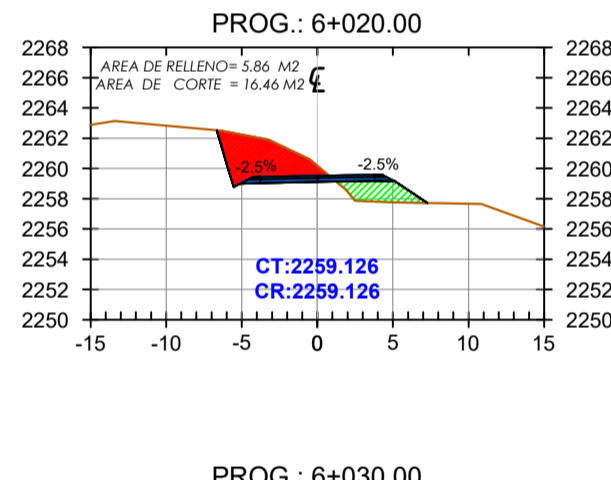
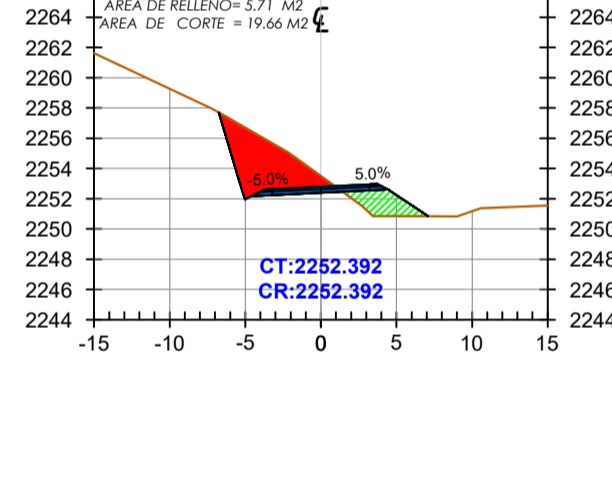
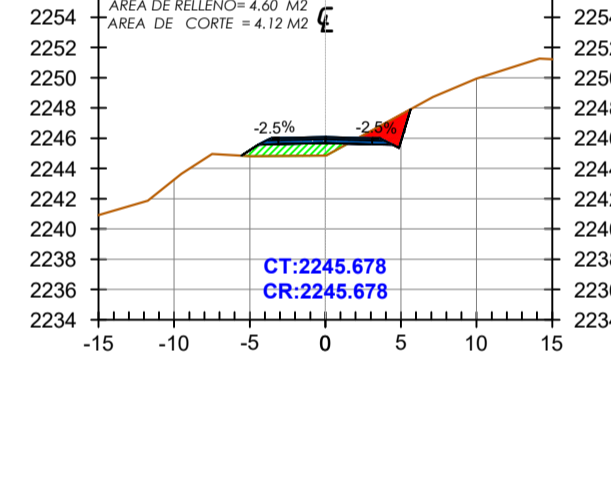
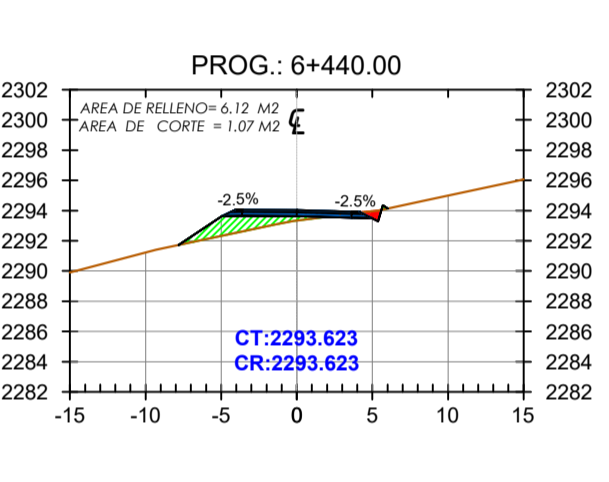
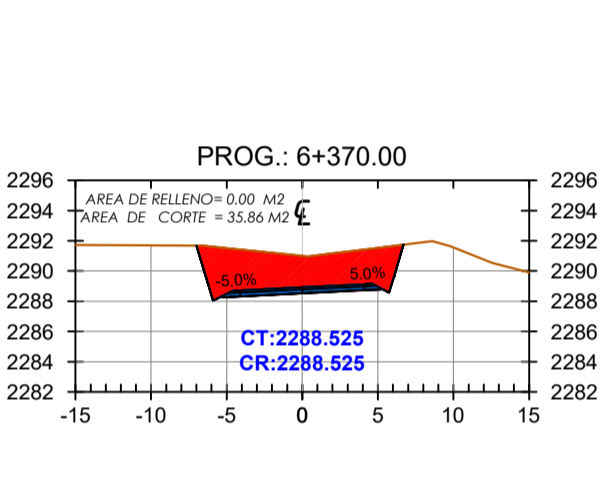
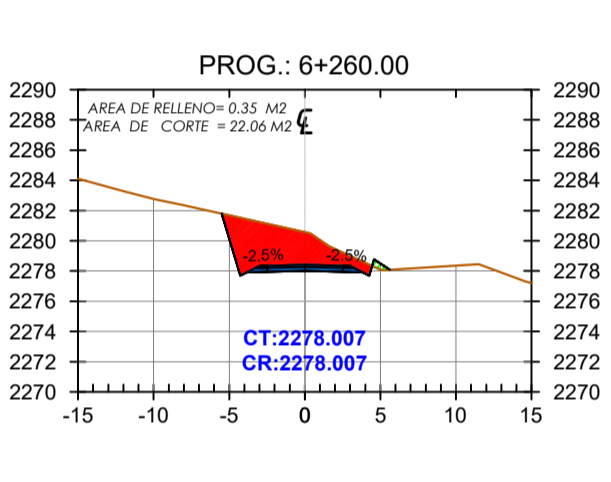
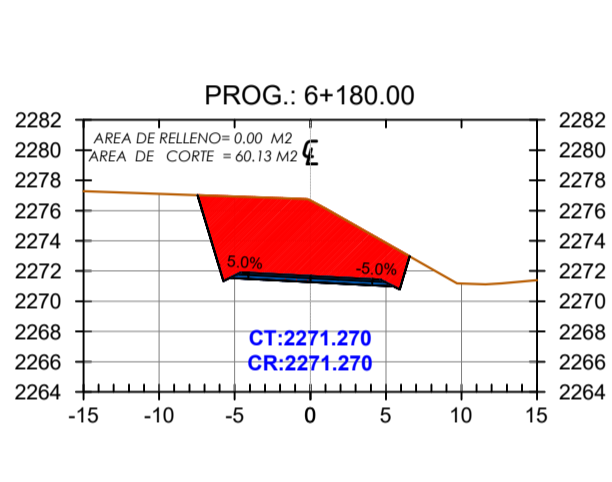
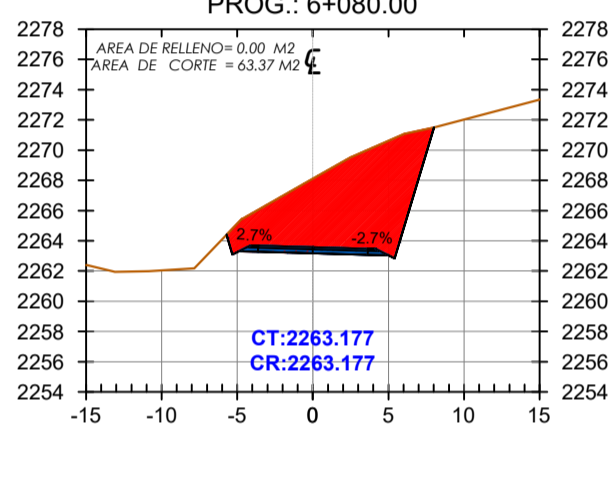
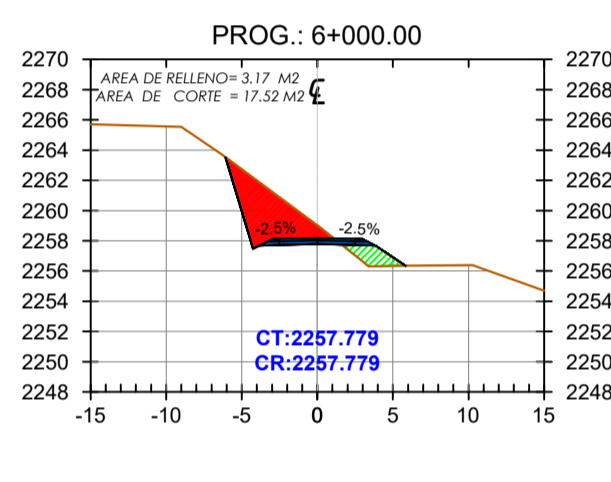
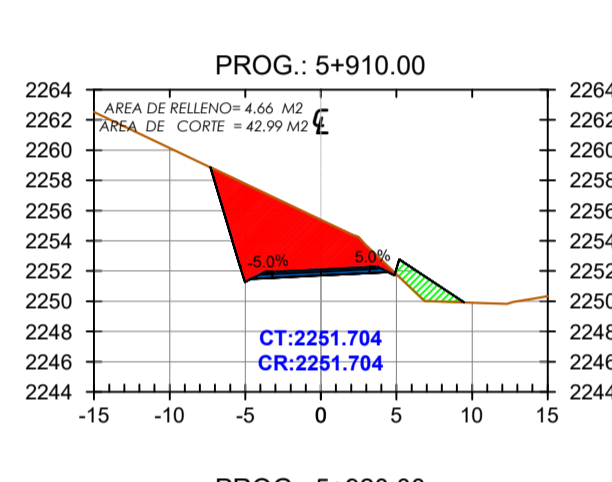
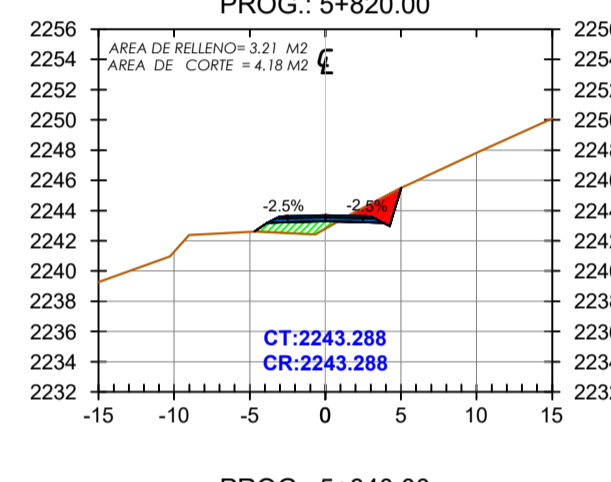
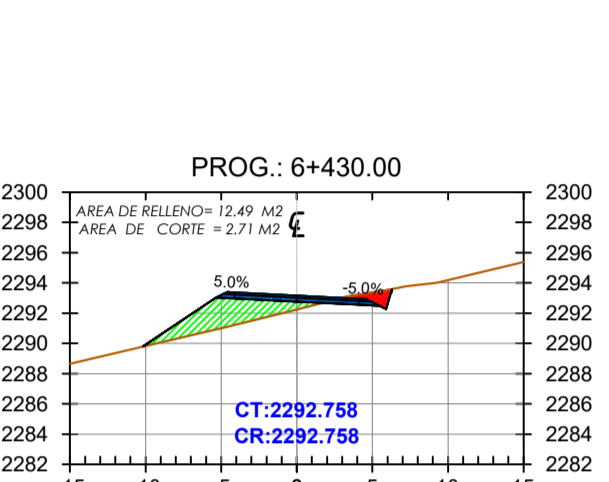
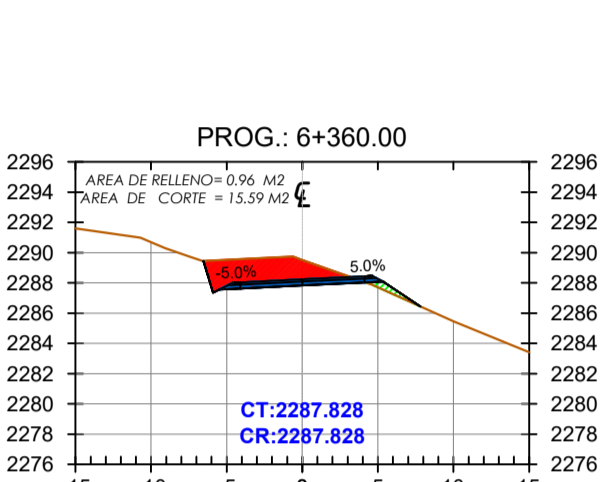
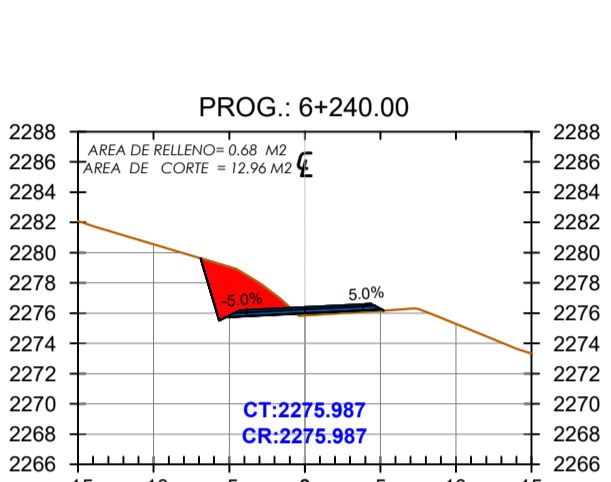
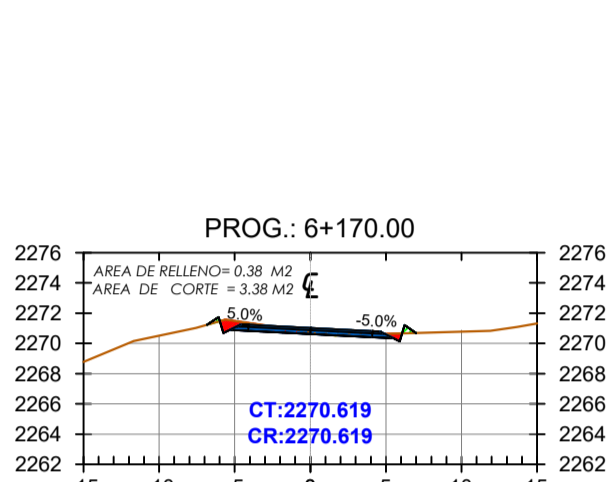
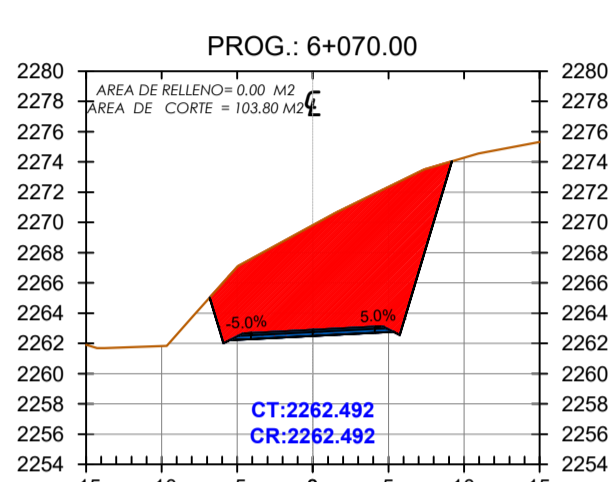
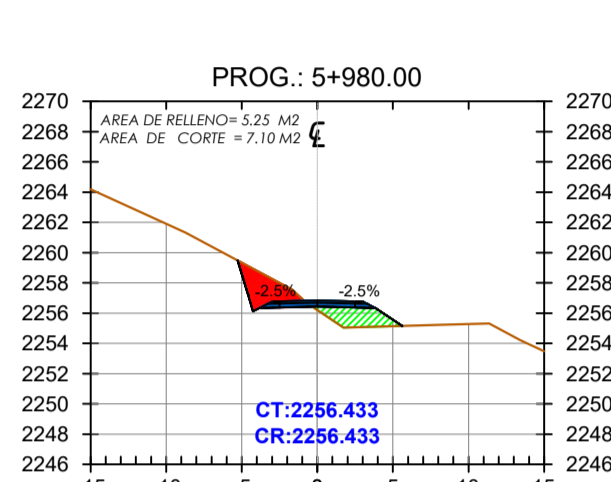
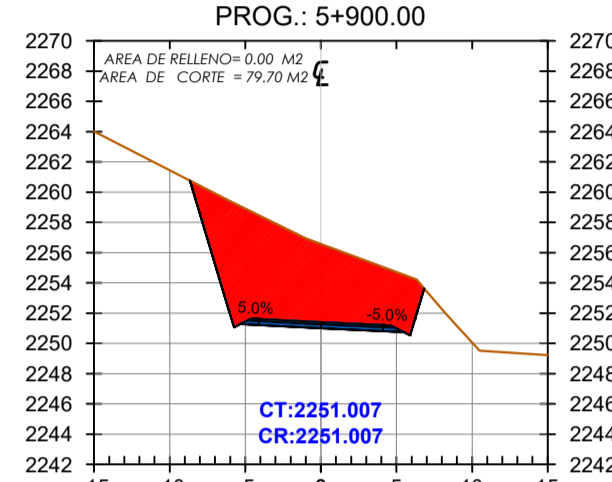
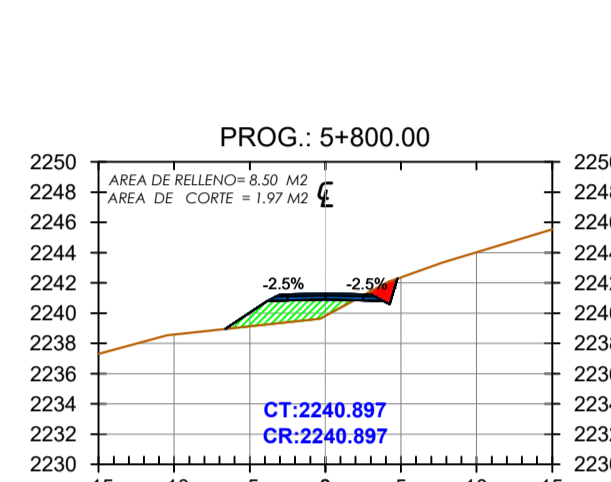
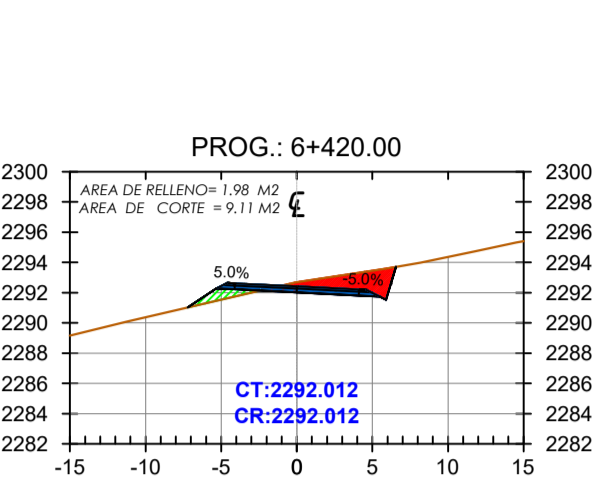
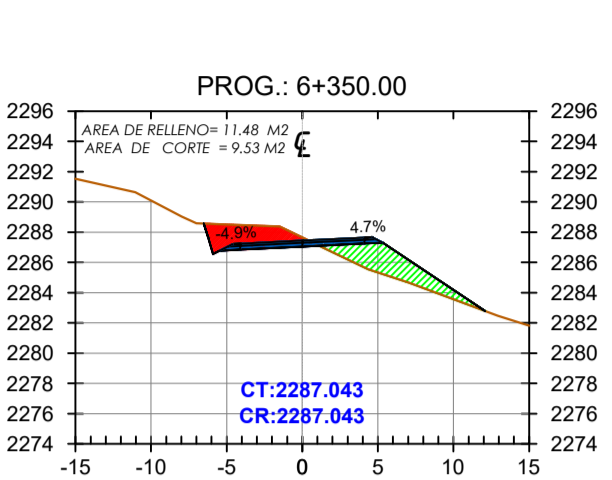
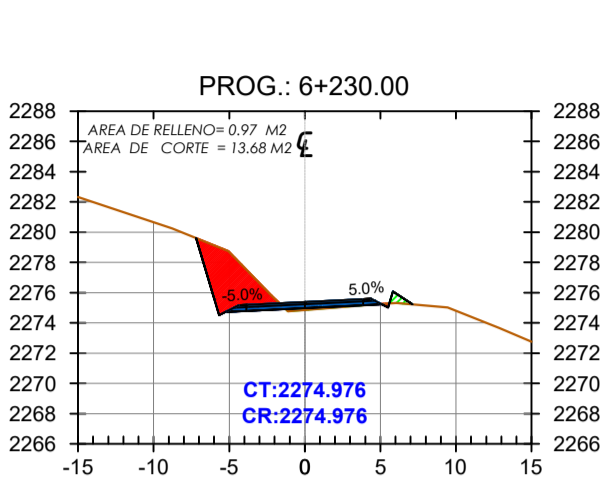
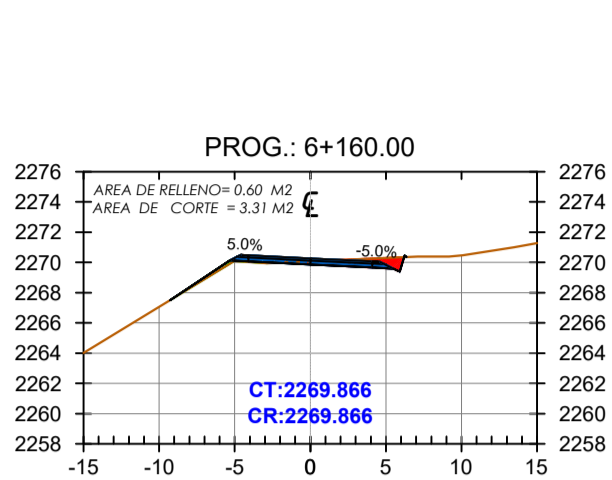
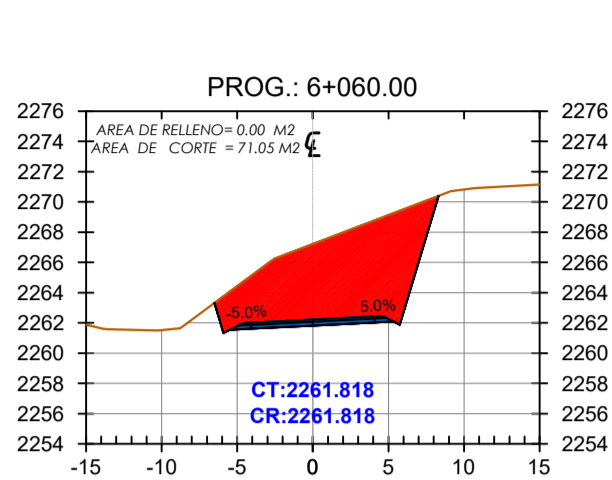
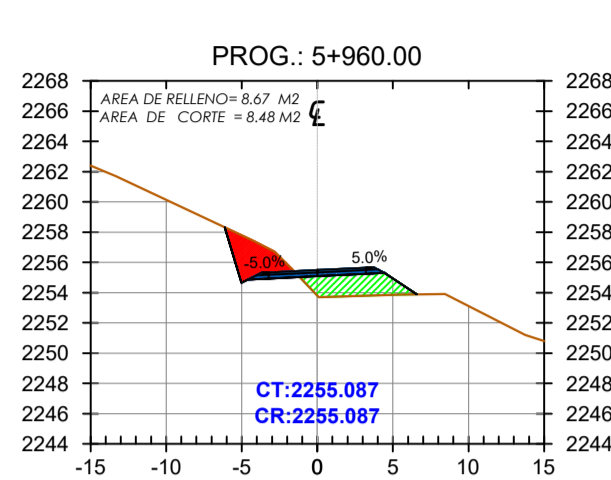
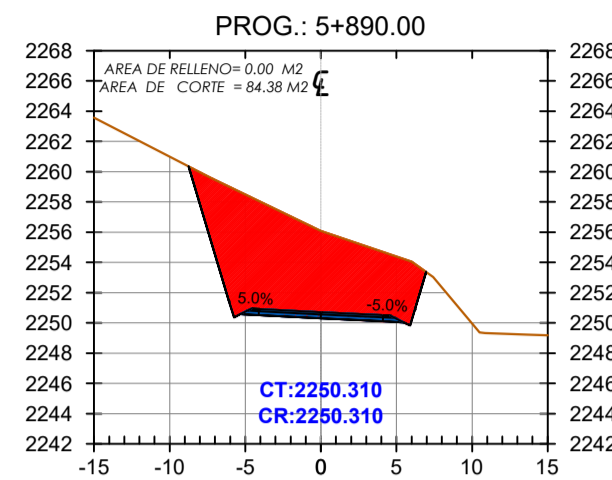
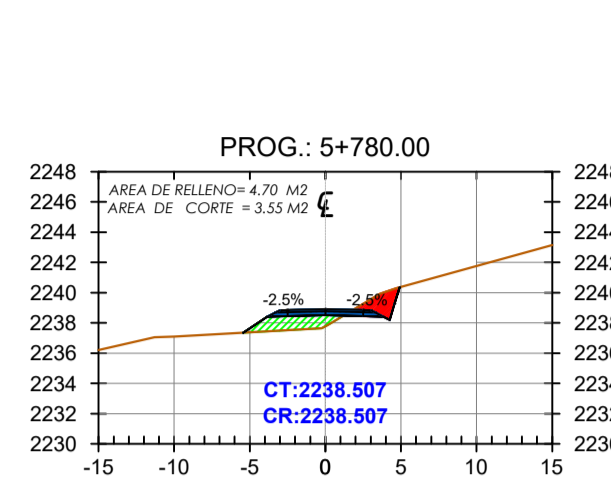

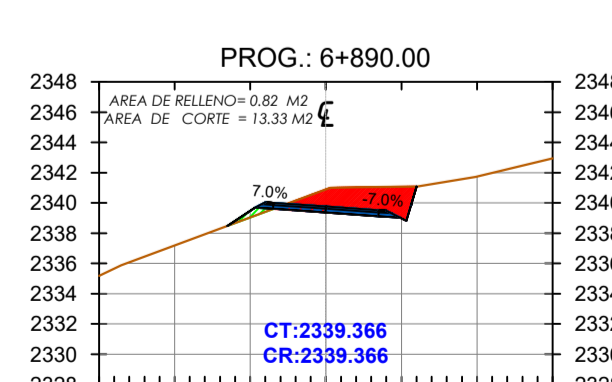
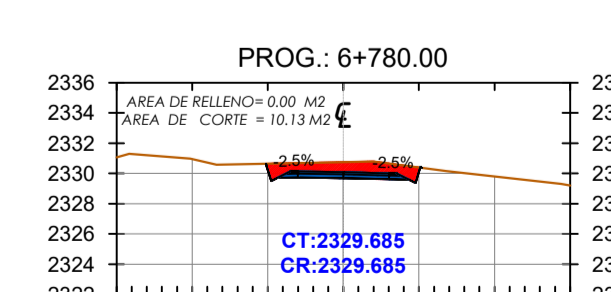
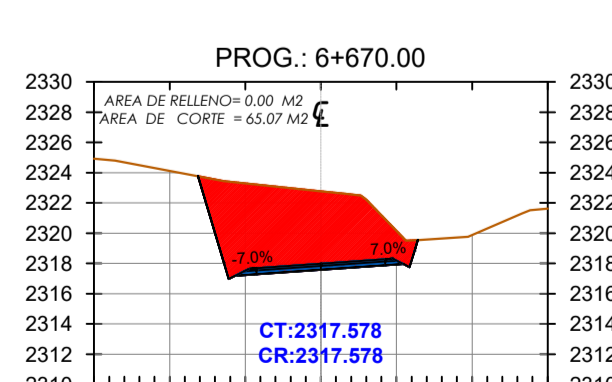
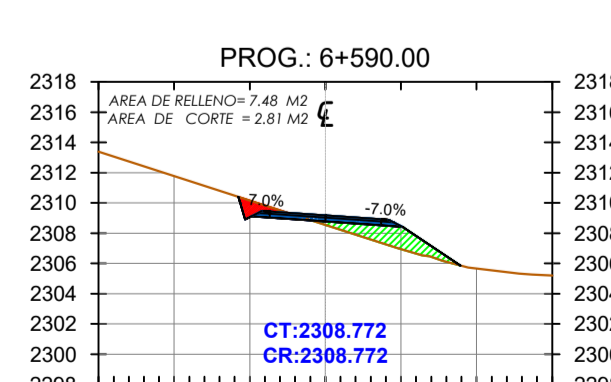
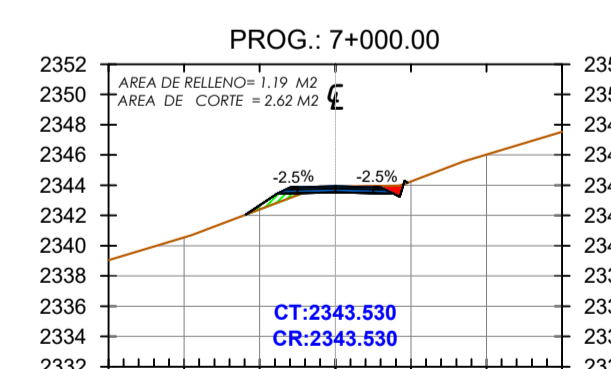
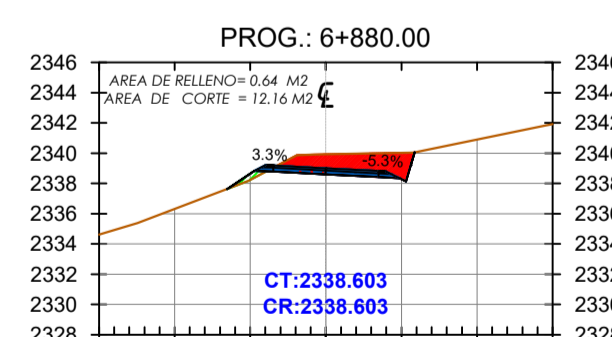
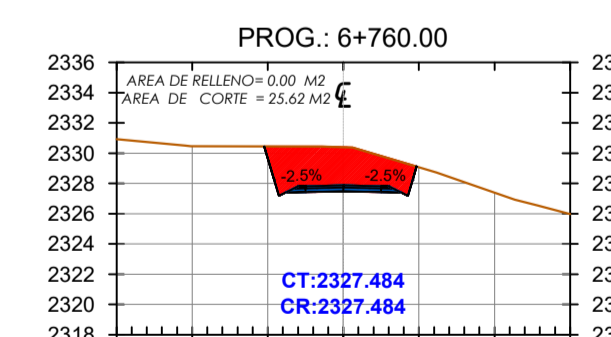
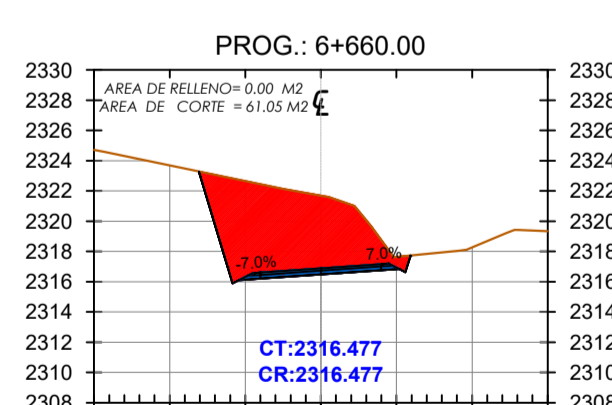
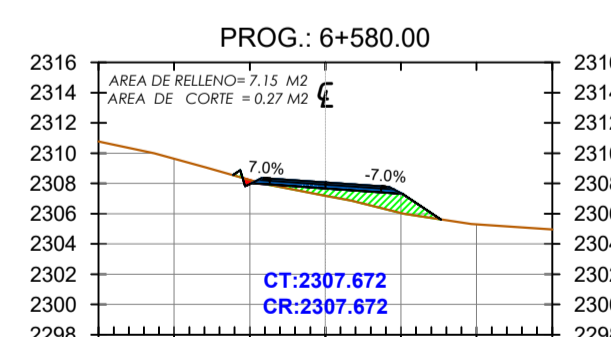
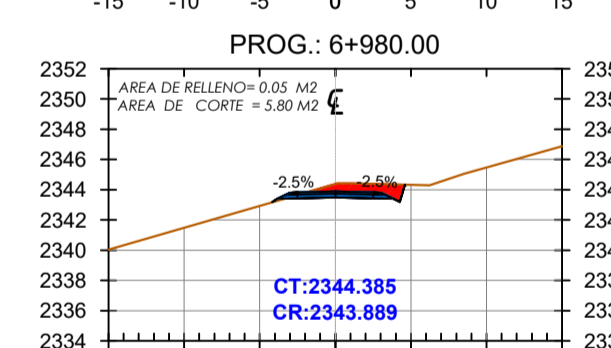
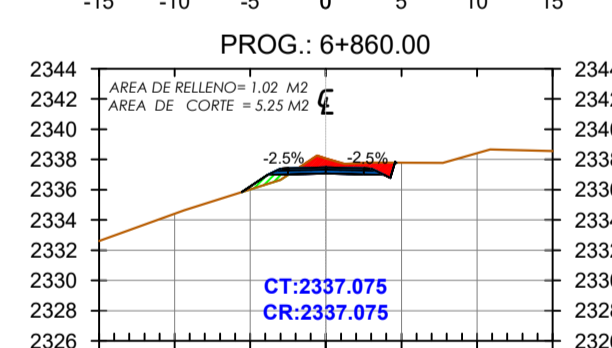
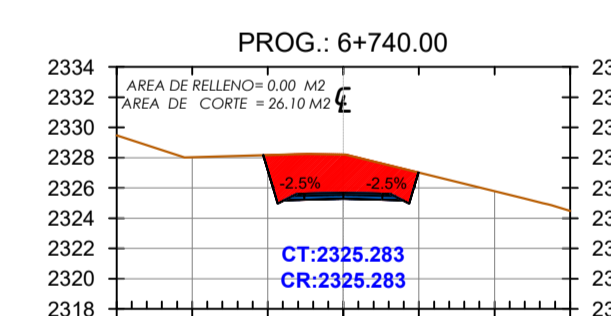
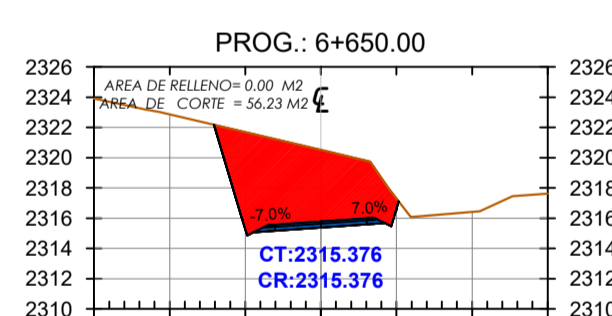
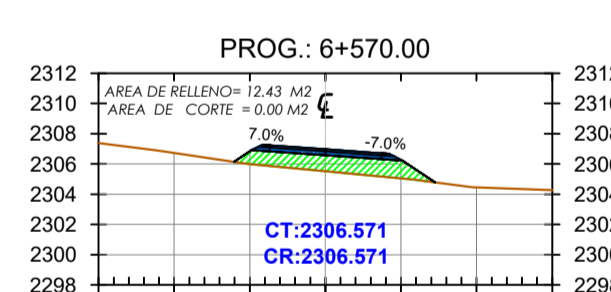
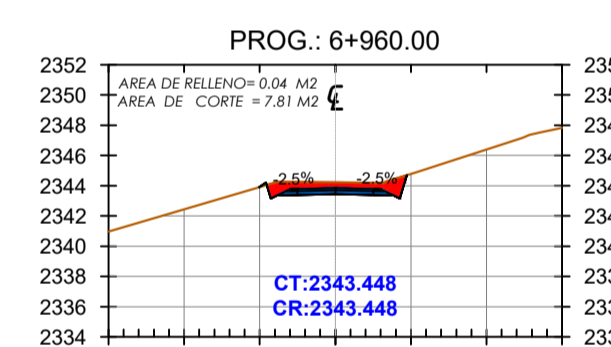
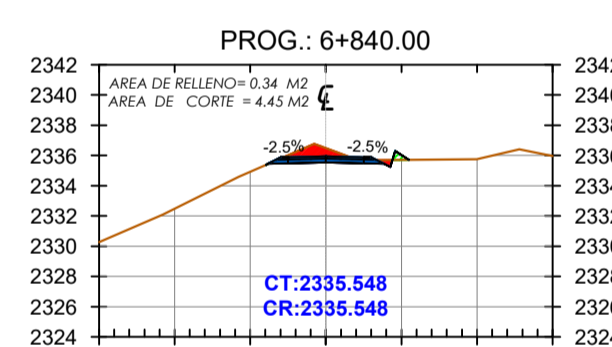
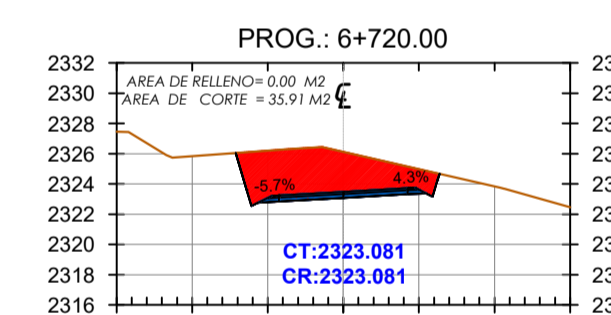
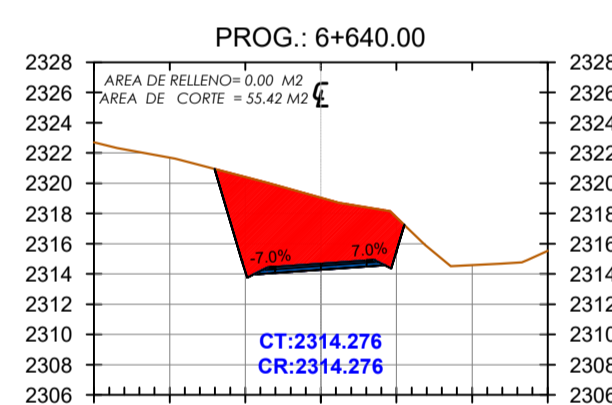
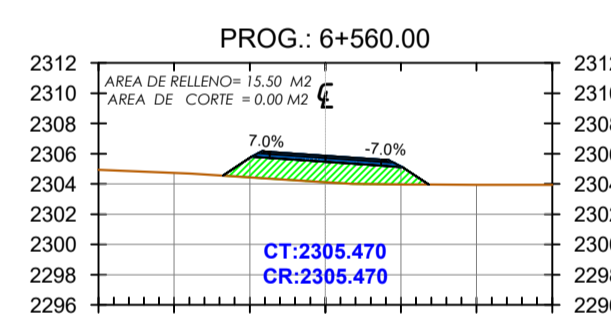
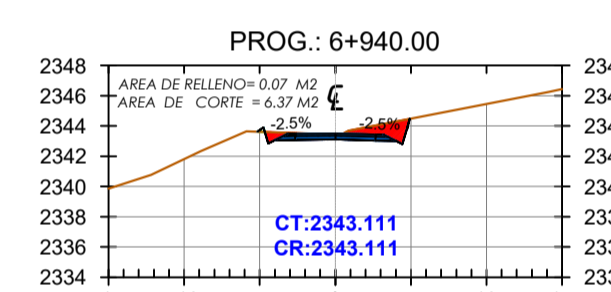
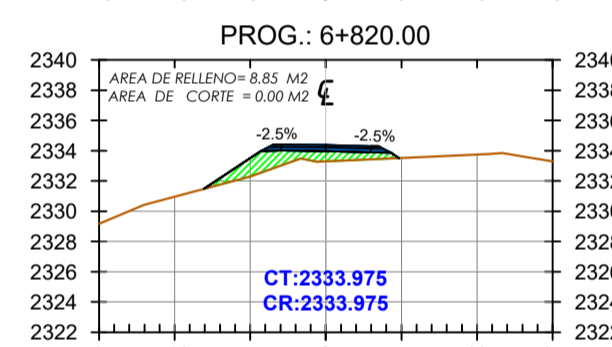
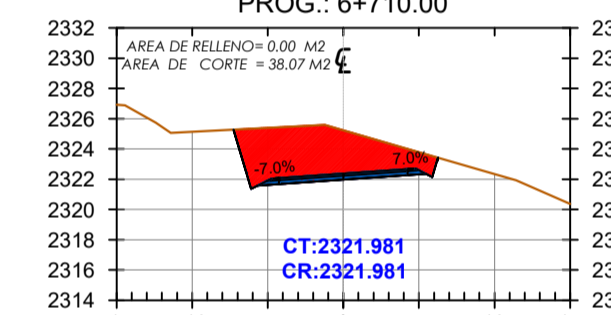
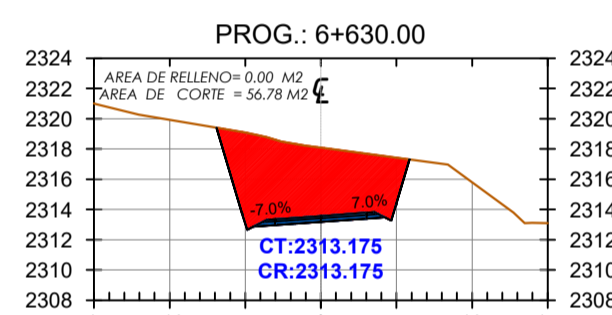
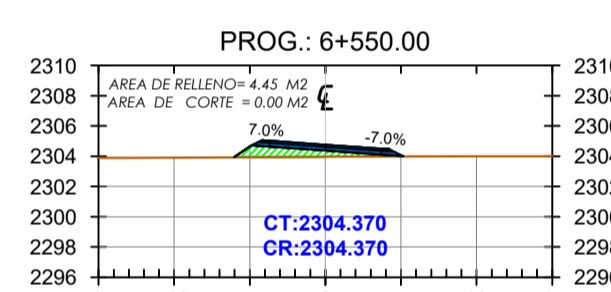
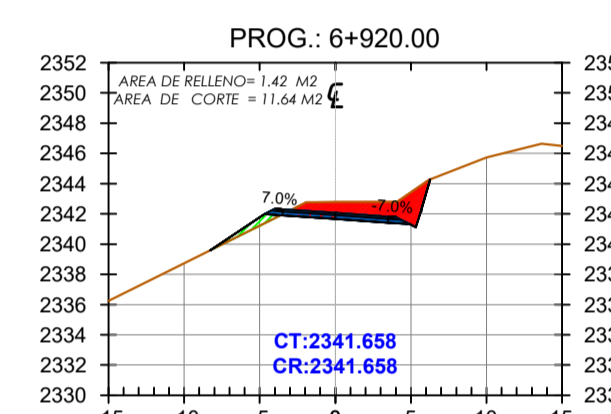
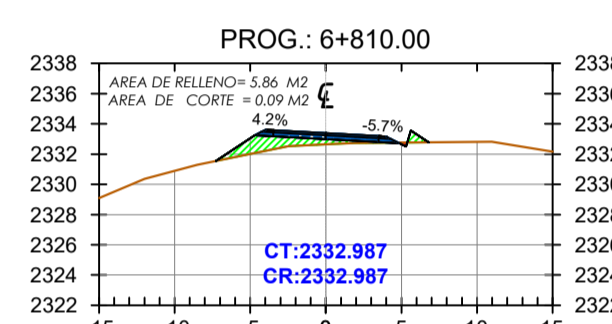
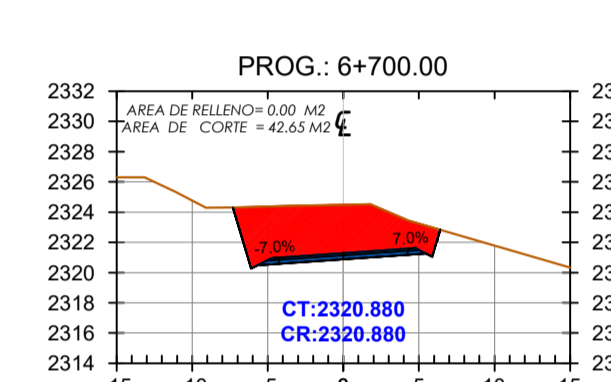
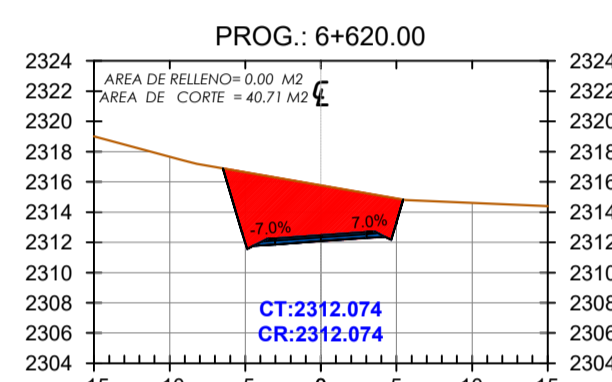
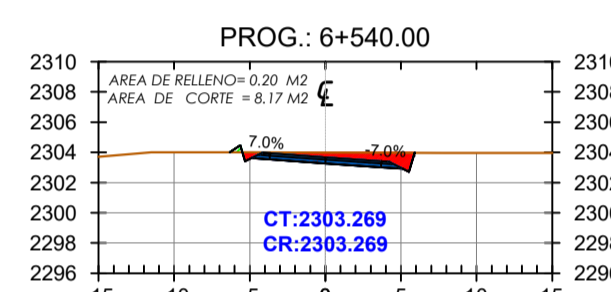
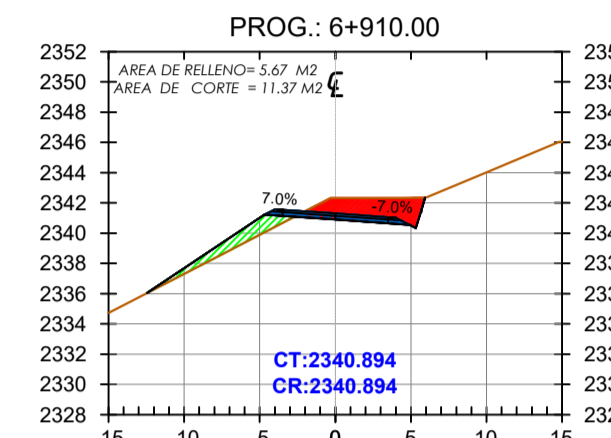
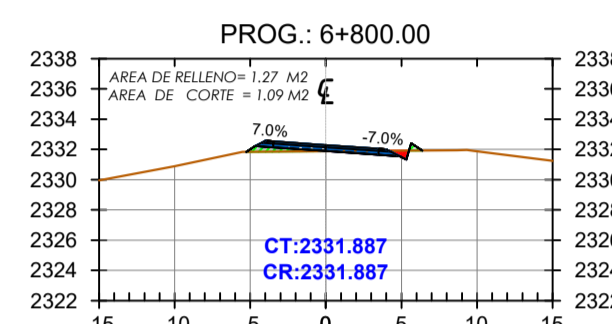
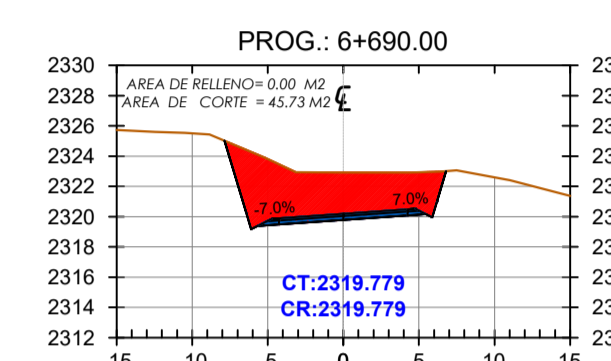
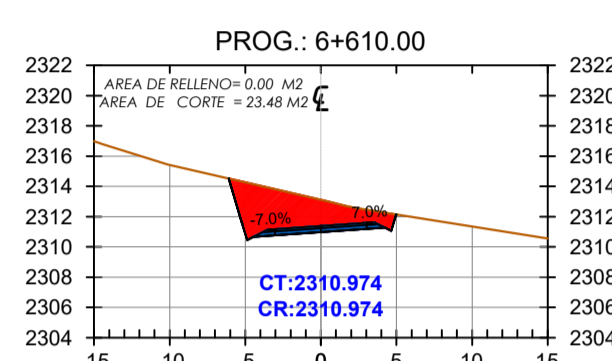
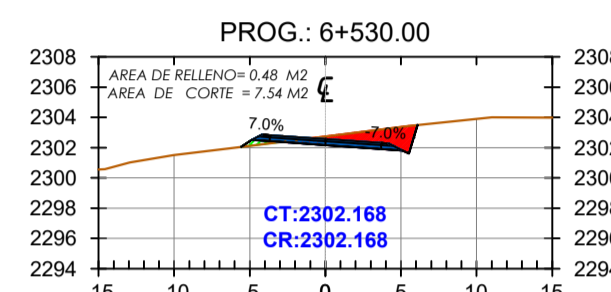
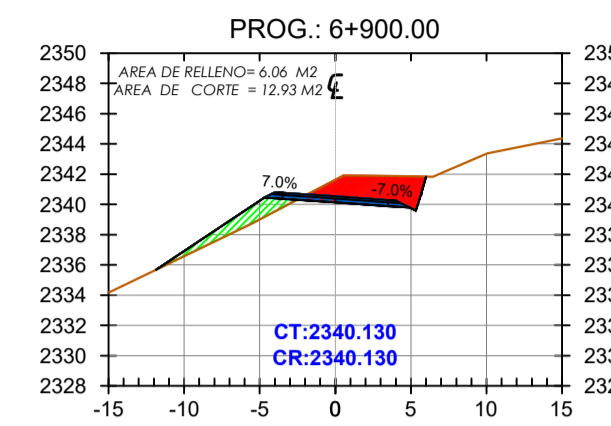
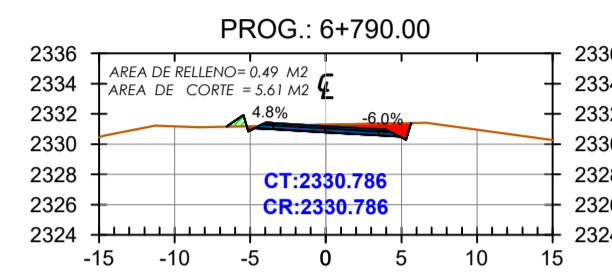
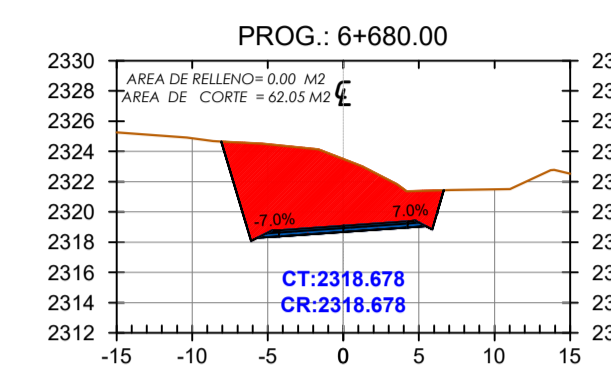
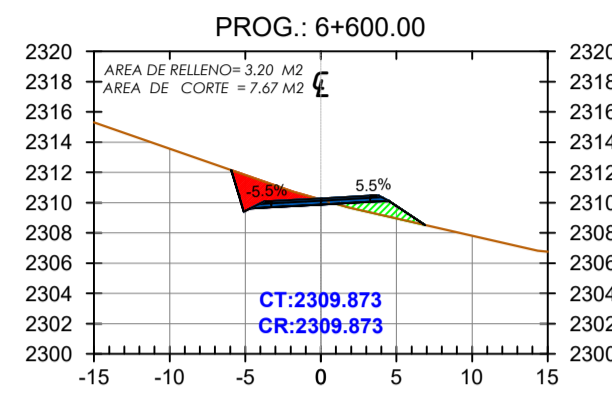
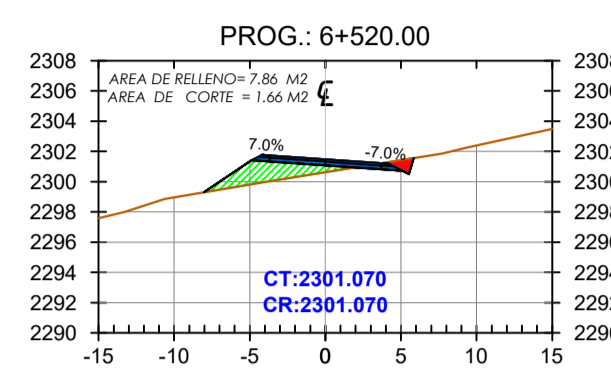

UNIVERSITARIO: BLADIMIR J. MARTINEZ MALLON

DOCENTE: MARCELO H. PACHECO NUÑES

UNIVERSIDAD AUTONOMA JUAN MISAEL SARACHO
 FACULTAD DE CIENCIAS Y TECNOLOGIA
 CARRERA DE INGENIERIA CIVIL
 ASIGNATURA: PROYECTO DE INGENIERIA CIVIL II CIV-502



Proyecto:

DISEÑO DE INGENIERIA TRAMO CARLAZO CENTRO - CARLAZO ESTE

Revisión:

Título: SECCIONES TRANSVERSALES

Escalas: 1:500

Progresivas: De: 6+520 A: 7+000

Nº de Lámina: 09/09

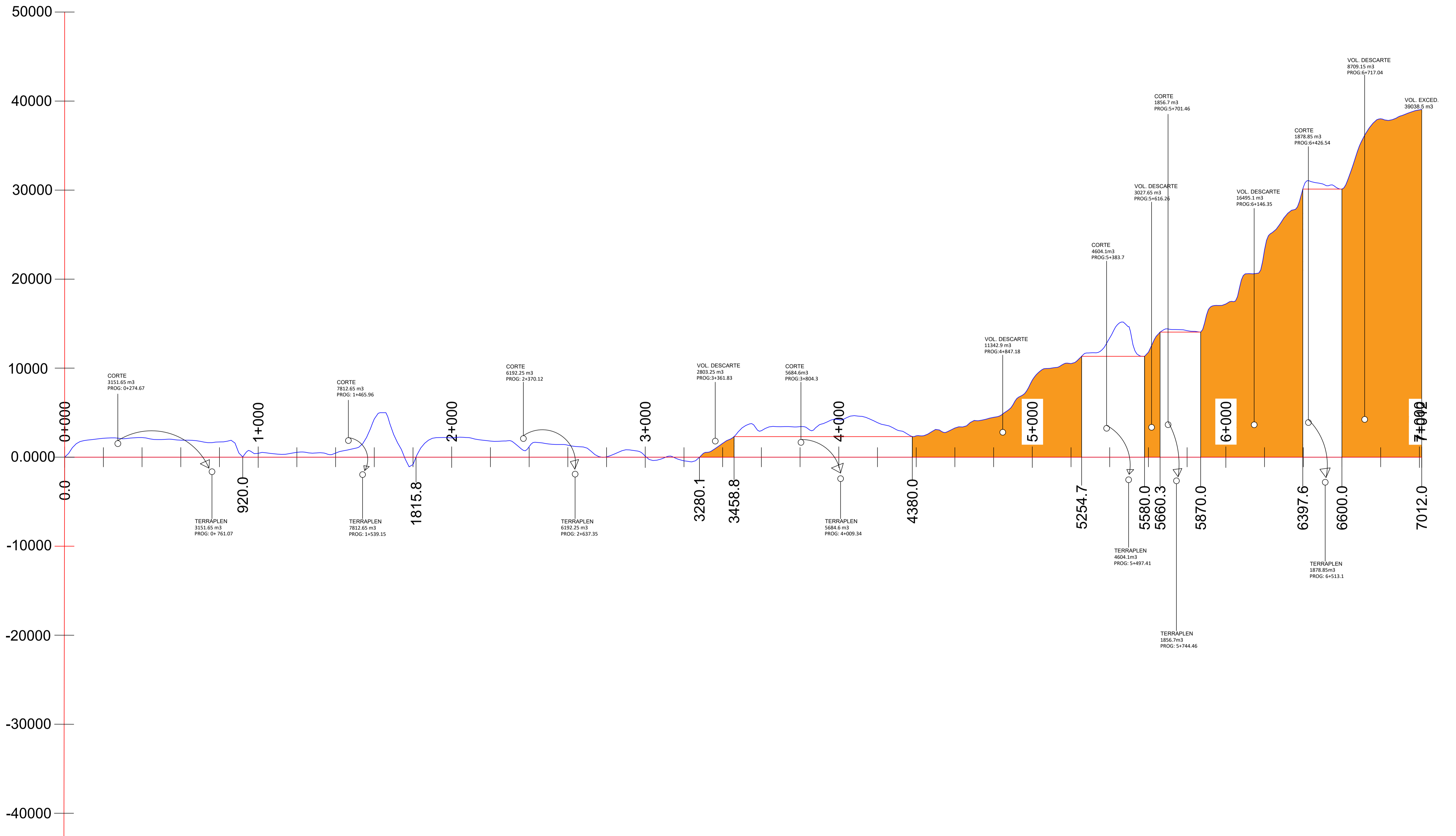

UNIVERSITARIO: BLADIMIR J. MARTINEZ MALLON
 DOCENTE: MARCELO H. PACHECO NUÑES

UNIVERSIDAD AUTONOMA JUAN MISAEL SARACHO
 FACULTAD DE CIENCIAS Y TECNOLOGIA
 CARRERA DE INGENIERIA CIVIL
 ASIGNATURA: PROYECTO DE INGENIERIA CIVIL II CIV-502



Proyecto:
 DISEÑO DE INGENIERIA TRAMO CARLAZO CENTRO - CARLAZO ESTE

Revisión:

Título: **DIAGRAMA DE MASAS**
 Escalas: **1:9000**
 Progresivas: De: 0+000, A: 7+012
 N° de Lámina: **1/1**

PERFIL LONGITUDINAL

Esc. 1:200

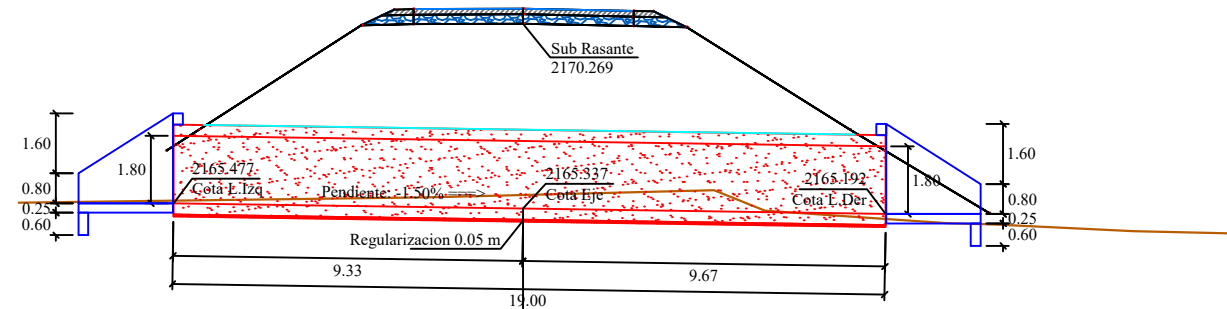

ALCANTARILLA	
Tipo:	CAJON
Sección:	DTC 3(2.0X1.8)
Esvío:	18.09°
Pendiente:	-1.50%
Longitud LI:	8.84
Longitud LD:	9.16
COTAS CONDUCTO	
Cota Izq.:	2165.469
Cota Eje:	2165.336
Cota Der.:	2165.199

VISTA FRONTAL

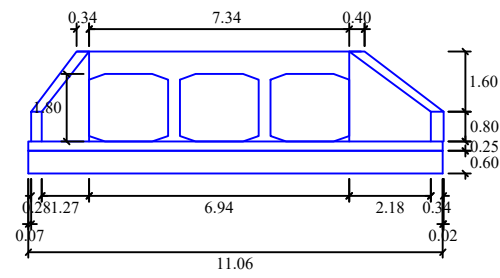

VISTA FRONTAL

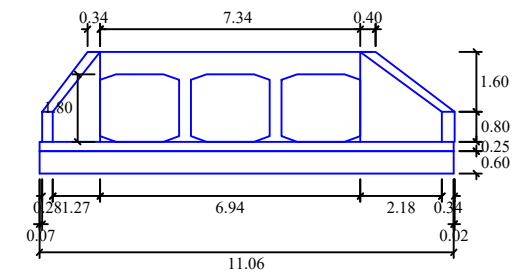

PLANTA

Esc. 1:200

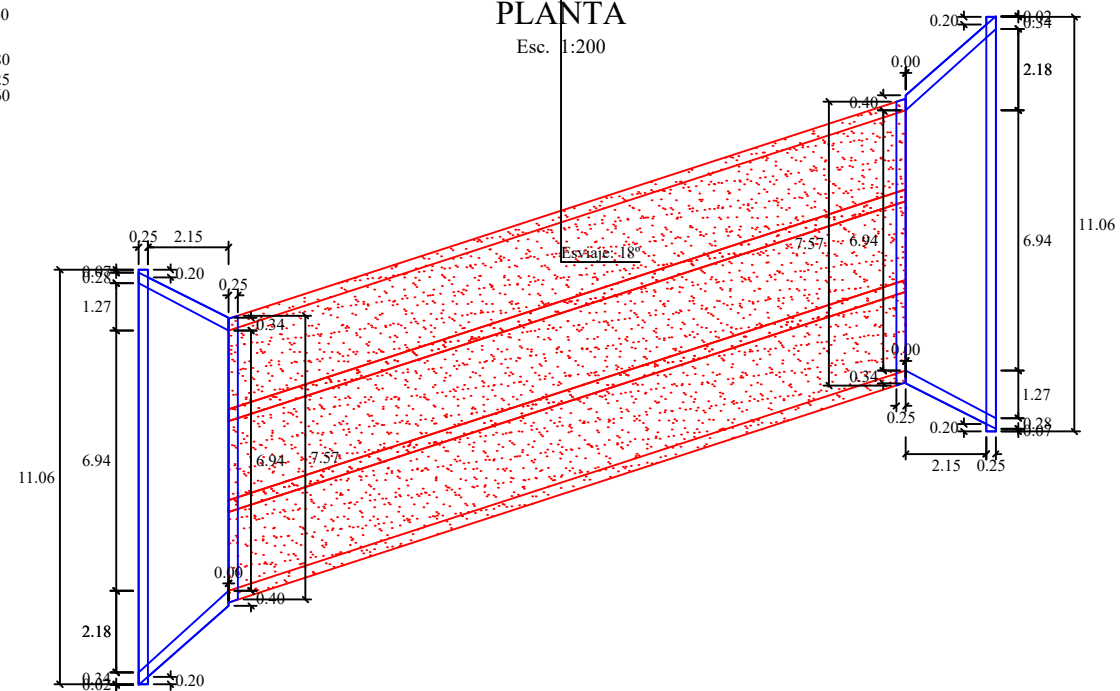

UNIVERSITARIO: BLADIMIR J. MARTINEZ MALLON

Proyecto:

DISEÑO DE INGENIERIA
TRAMO CARLAZO CENTRO - CARLAZO ESTE

DOCENTE: MARCELO H. PACHECO NUÑES

UNIVERSIDAD AUTONOMA JUAN MISAEL SARACHO
FACULTAD DE CIENCIAS Y TECNOLOGIA
CARRERA DE INGENIERIA CIVIL
ASIGNATURA: PROYECTO DE INGENIERIA CIVIL II CIV-502



Revisión:

OBRAS DE DRENAJE

ALCANTARILLA DTC 3(2X1.8)

PLANTA PERFIL

Prog.: 0+897.34

LAMINA:	ESCALA:
1/11	INDICADA

PERFIL LONGITUDINAL

Esc. 1:75

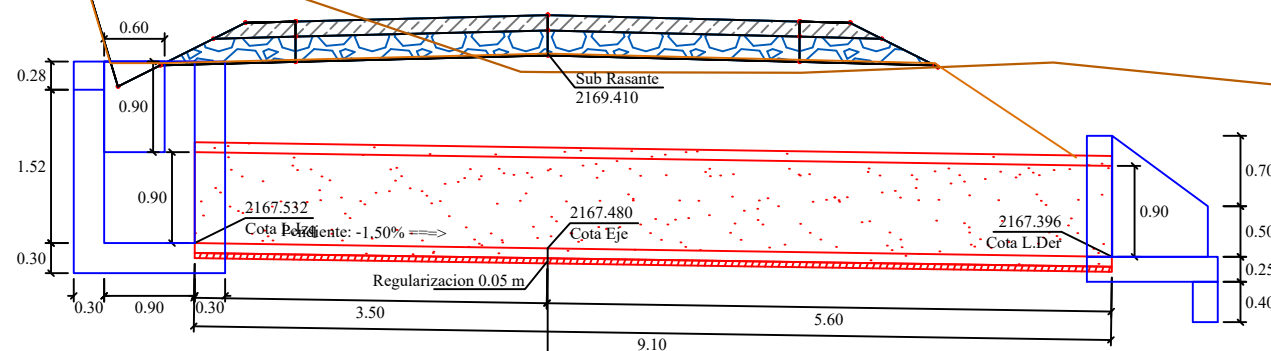

ALCANTARILLA	
Tipo.....:	TUBO
Seccion...:	1ATH Ø 0.9
Esviaje....:	0.00°
Pendiente..:	-1.50%
Longitud LI.:	3.50
Longitud LD.:	5.60

COTAS CONDUCTO	
Cota Izq.:	2167.532
Cota Eje.:	2167.480
Cota Der.:	2167.396

PLANTA

Esc. 1:75

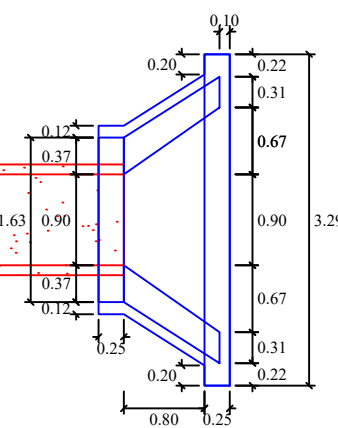
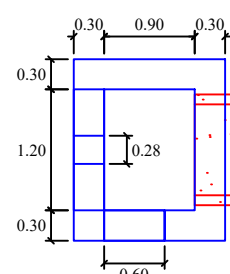
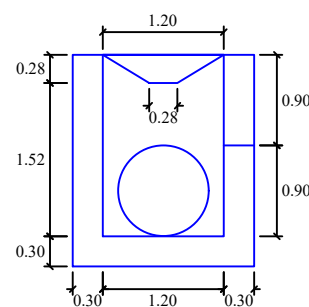

VISTA FRONTAL

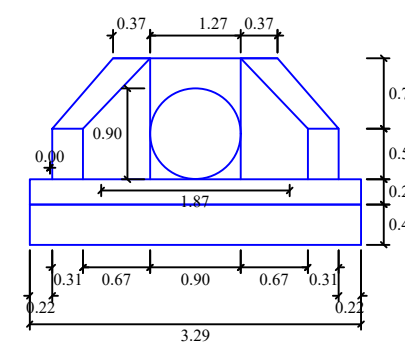

UNIVERSITARIO: BLADIMIR J. MARTINEZ MALLON	Proyecto:	UNIVERSIDAD AUTONOMA JUAN MISAEL SARACHO FACULTAD DE CIENCIAS Y TECNOLOGIA CARRERA DE INGENIERIA CIVIL ASIGNATURA: PROYECTO DE INGENIERIA CIVIL II CIV-502		Revisión:	OBRAS DE DRENAJE		Prog.: 1+135
	DOCENTE: MARCELO H. PACHECO NUÑES				DISEÑO DE INGENIERIA TRAMO CARLAZO CENTRO - CARLAZO ESTE	ALCANTARILLA 1ATH Ø 0.9	
					PLANTA PERFIL		

PERFIL LONGITUDINAL

Esc. 1:75

ALCANTARILLA	
Tipo.....:	TUBO
Seccion...:	1ATH Ø 0.9
Esviaje....:	0.00°
Pendiente..:	-1.60%
Longitud LI.:	4.50
Longitud LD.:	7.50

COTAS CONDUCTO	
Cota Izq.:	2168.318
Cota Eje.:	2168.246
Cota Der.:	2168.126

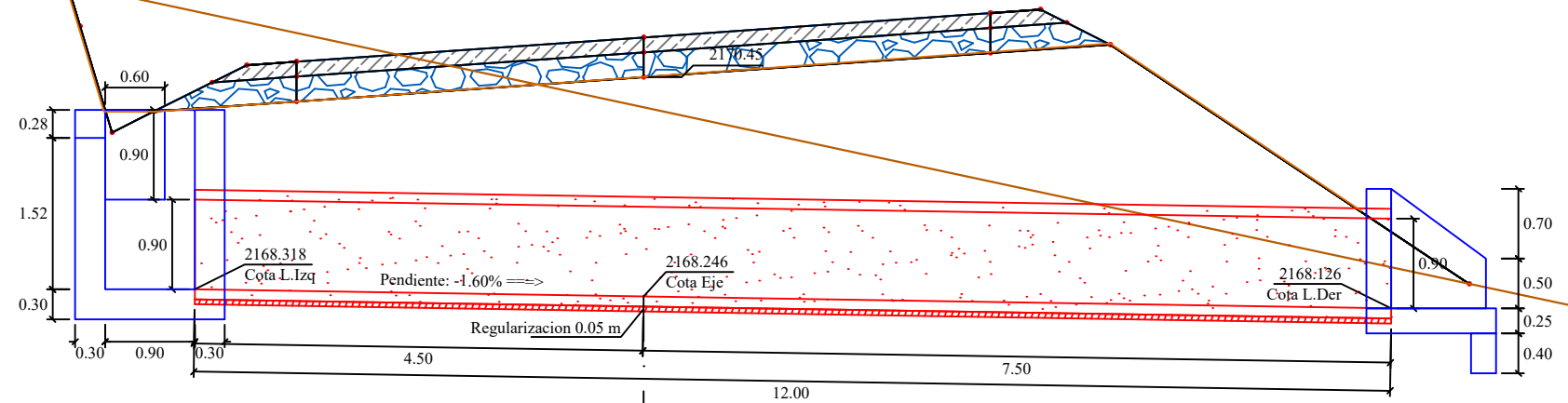

PLANTA

Esc. 1:75

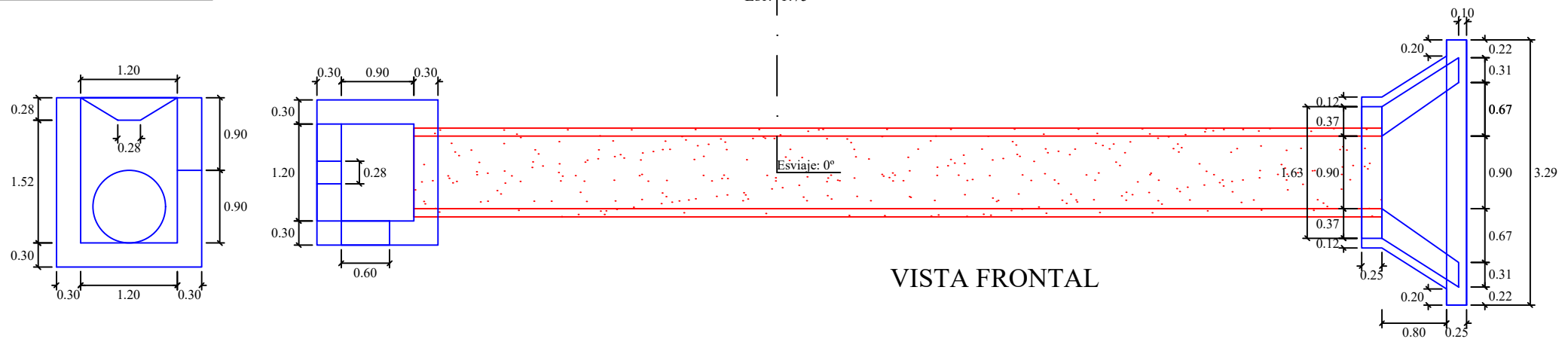

VISTA FRONTAL

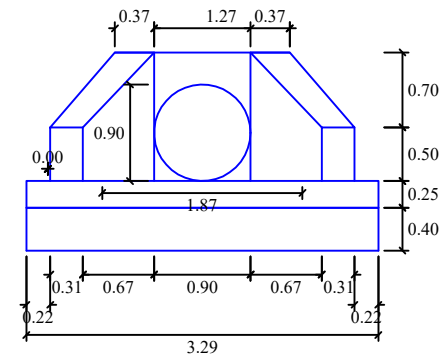

UNIVERSITARIO: BLADIMIR J. MARTINEZ MALLON

Proyecto:

DISEÑO DE INGENIERIA
TRAMO CARLAZO CENTRO - CARLAZO ESTE

DOCENTE: MARCELO H. PACHECO NUÑES

UNIVERSIDAD AUTONOMA JUAN MISAEL SARACHO
FACULTAD DE CIENCIAS Y TECNOLOGIA
CARRERA DE INGENIERIA CIVIL
ASIGNATURA: PROYECTO DE INGENIERIA CIVIL II CIV-502



Revisión:

OBRAS DE DRENAJE

ALCANTARILLA 1ATH Ø 0.9

PLANTA PERFIL

Prog.: 1+365

LAMINA: 3/11
ESCALA: INDICADA

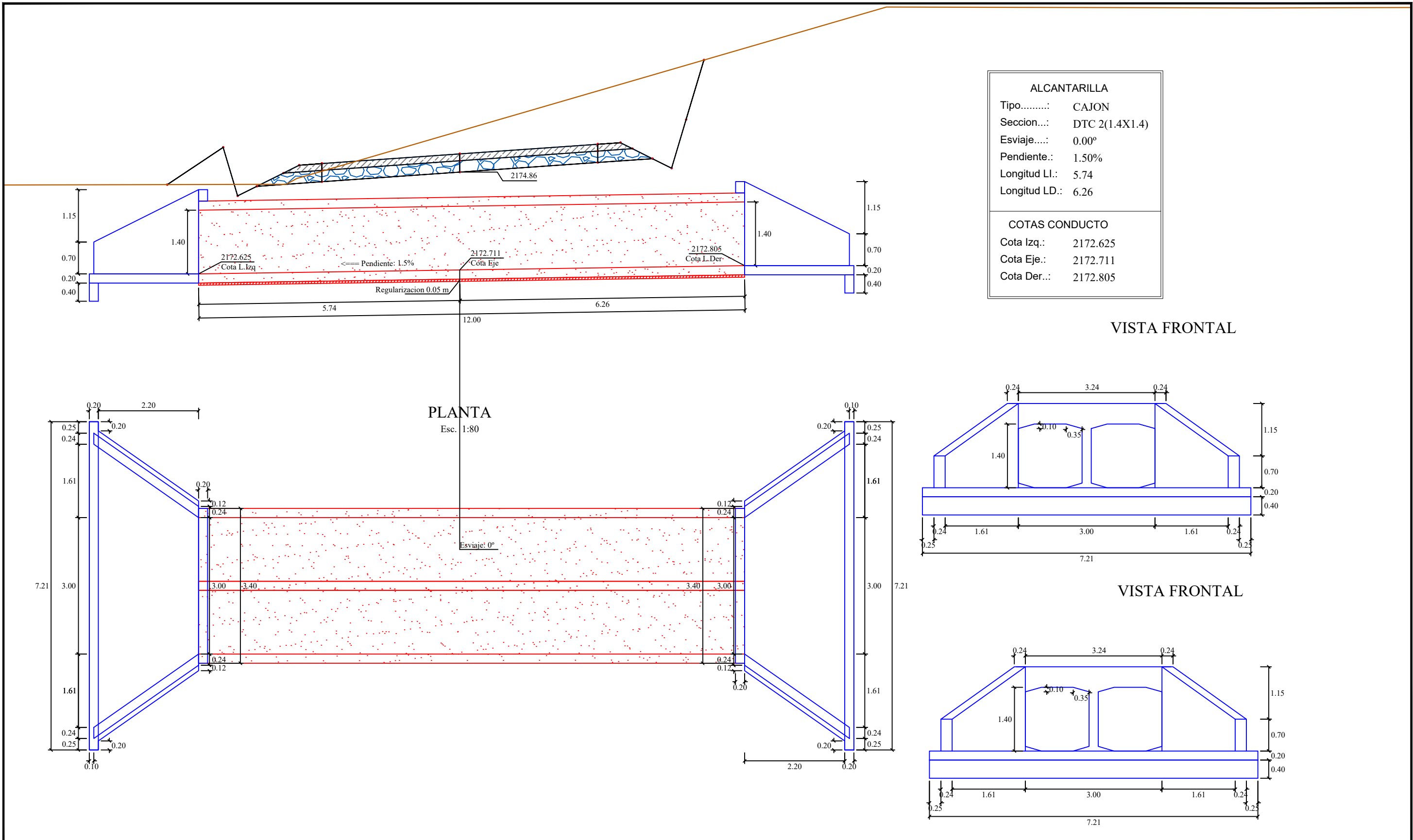

UNIVERSITARIO: BLADIMIR J. MARTINEZ MALLON DOCENTE: MARCELO H. PACHECO NUÑES	Proyecto: DISEÑO DE INGENIERIA TRAMO CARLAZO CENTRO - CARLAZO ESTE	UNIVERSIDAD AUTONOMA JUAN MISAEL SARACHO FACULTAD DE CIENCIAS Y TECNOLOGIA CARRERA DE INGENIERIA CIVIL ASIGNATURA: PROYECTO DE INGENIERIA CIVIL II CIV-502		Revisión:	OBRAS DE DRENAJE	Prog.: 2+420
				ALCANTARILLA DTC 2(1.4X1.4)	LAMINA: 4/11	ESCALA: INDICADA
					PLANTA PERFIL	

PERFIL LONGITUDINAL

Esc. 1:120

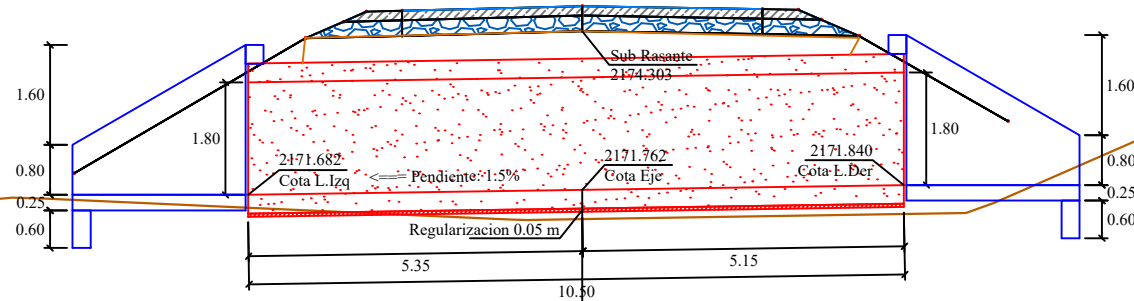

ALCANTARILLA	
Tipo.....	CAJON
Seccion....	DTC 3(2.0X1.8)
Esviaje....	30.00°
Pendiente..	1.50%
Longitud LI:	5.35
Longitud LD:	5.15
COTAS CONDUCTO	
Cota Izq.:	2171.682
Cota Eje:	2171.762
Cota Der.:	2171.840

PLANTA

Esc. 1:120

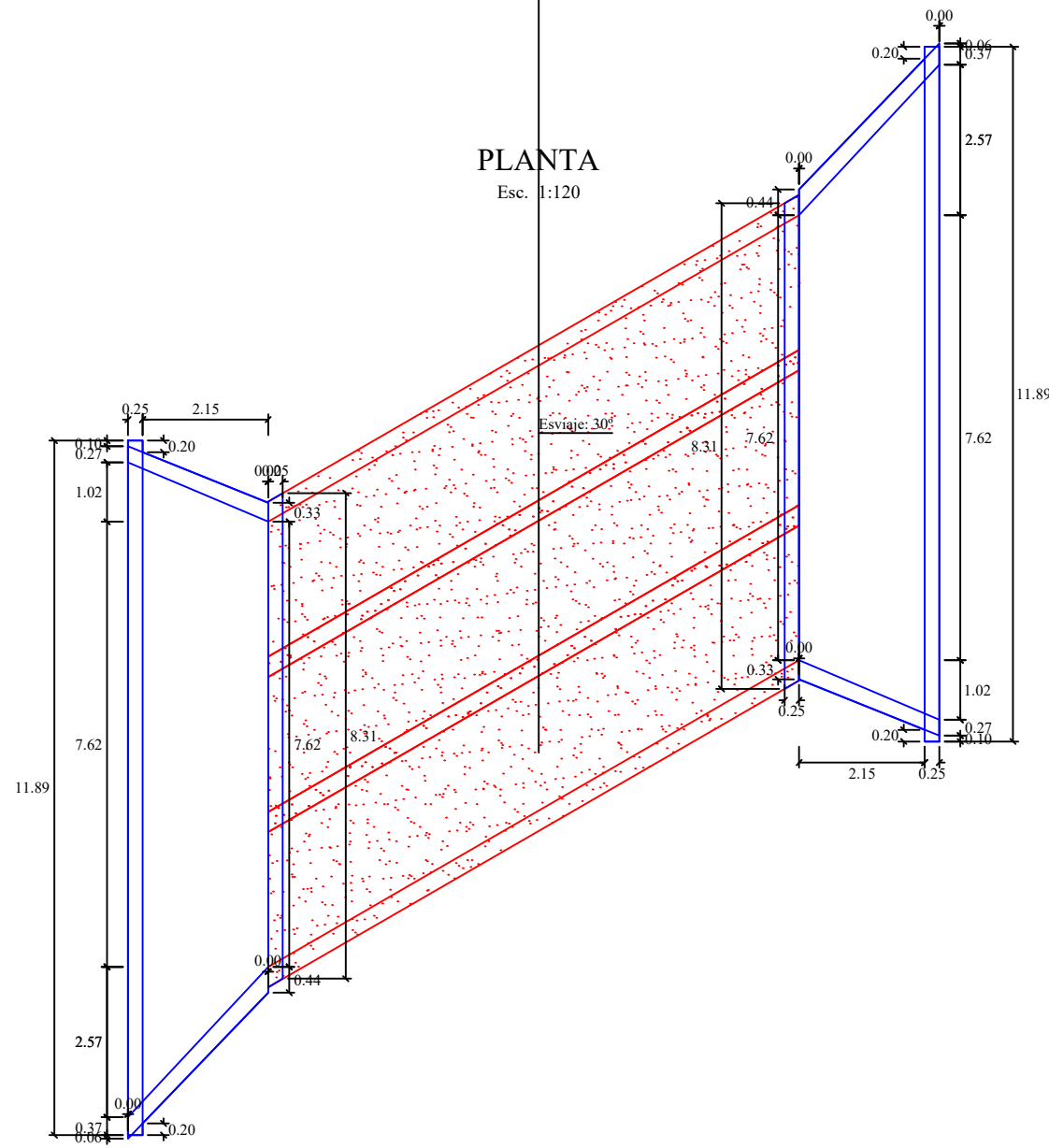

VISTA FRONTAL

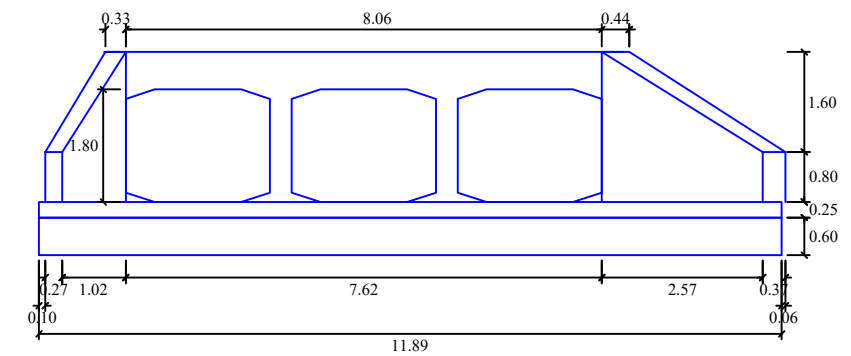

VISTA FRONTAL

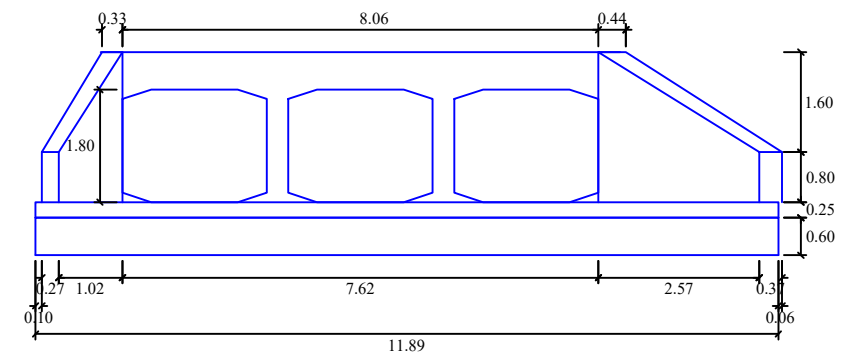

UNIVERSITARIO: BLADIMIR J. MARTINEZ MALLON

Proyecto:

DISEÑO DE INGENIERIA
 TRAMO CARLAZO CENTRO - CARLAZO ESTE

DOCENTE: MARCELO H. PACHECO NUÑES

UNIVERSIDAD AUTONOMA JUAN MISAEL SARACHO
 FACULTAD DE CIENCIAS Y TECNOLOGIA
 CARRERA DE INGENIERIA CIVIL
 ASIGNATURA: PROYECTO DE INGENIERIA CIVIL II CIV-502



Revisión:

OBRAS DE DRENAJE

ALCANTARILLA DTC 3(2X2)

PLANTA PERFIL

Prog.: 2+730

LAMINA: 5/11
 ESCALA: INDICADA

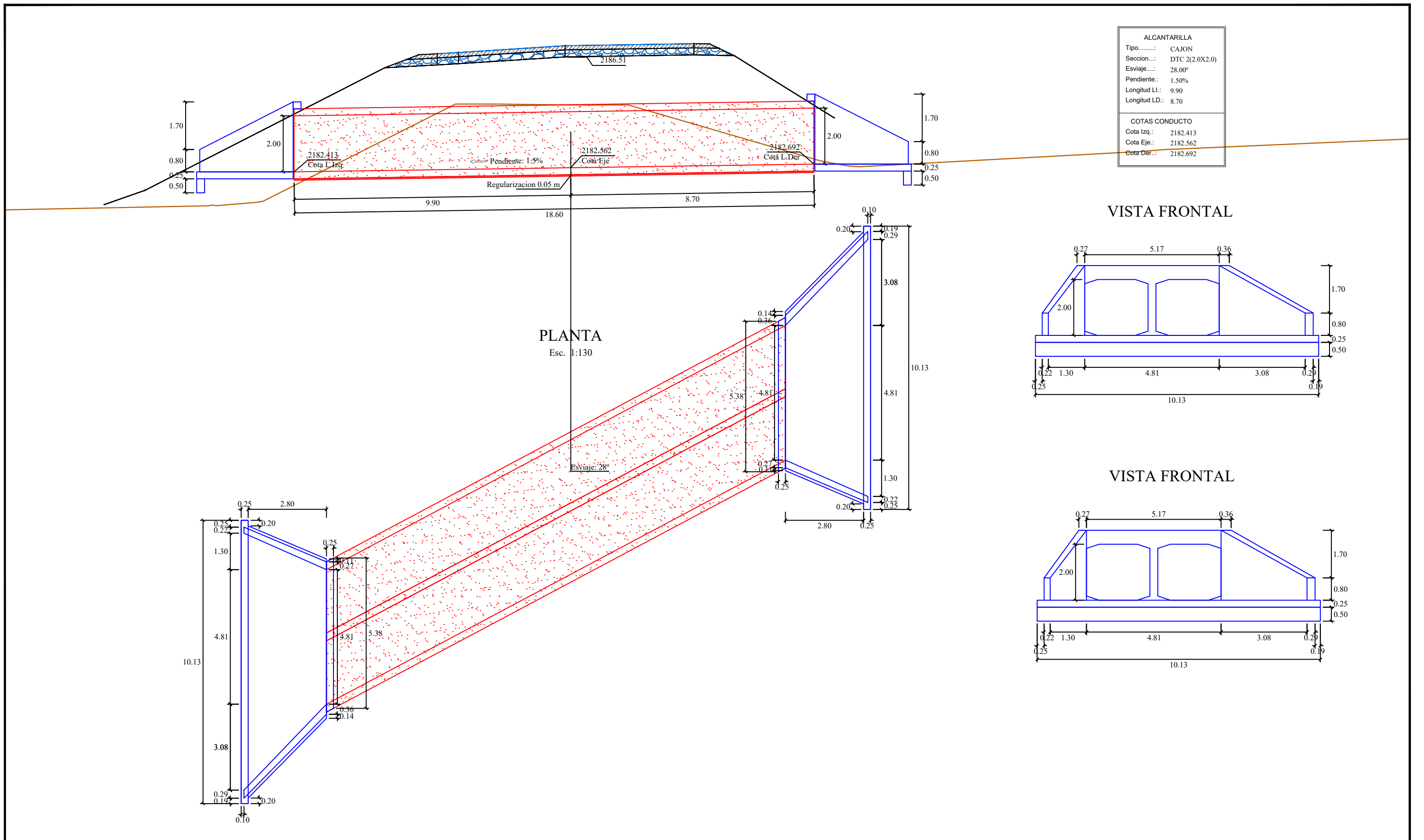

UNIVERSITARIO: BLADIMIR J. MARTINEZ MALLON

Proyecto:

DISEÑO DE INGENIERIA
TRAMO CARLAZO CENTRO - CARLAZO ESTE

DOCENTE: MARCELO H. PACHECO NUÑES

UNIVERSIDAD AUTONOMA JUAN MISAEL SARACHO
FACULTAD DE CIENCIAS Y TECNOLOGIA
CARRERA DE INGENIERIA CIVIL
ASIGNATURA: PROYECTO DE INGENIERIA CIVIL II CIV-502



Revisión:

OBRAS DE DRENAJE
ALCANTARILLA DTC 2(2X2)
PLANTA PERFIL

Prog.: 3+572

LAMINA: 6/11
ESCALA: INDICADA

PERFIL LONGITUDINAL

Esc. 1:75

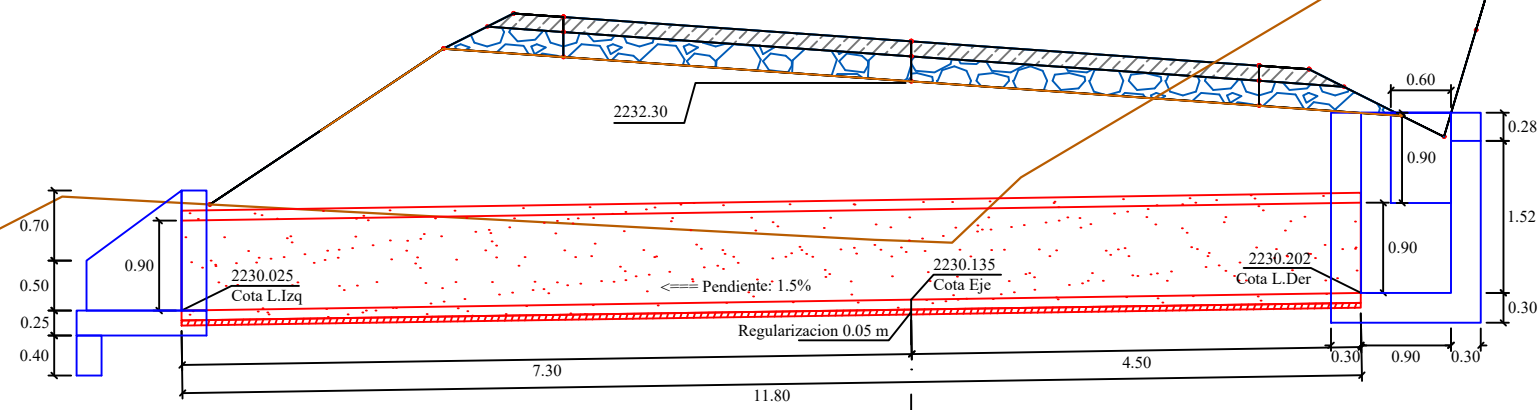

ALCANTARILLA	
Tipo.....:	TUBO
Seccion....:	1ATH Ø 0.9
Esviaje.....:	0.00°
Pendiente..:	1.50%
Longitud LI.:	7.30
Longitud LD.:	4.50
COTAS CONDUCTO	
Cota Izq.:	2230.025
Cota Eje.:	2230.135
Cota Der.:	2230.202

PLANTA

Esc. 1:75

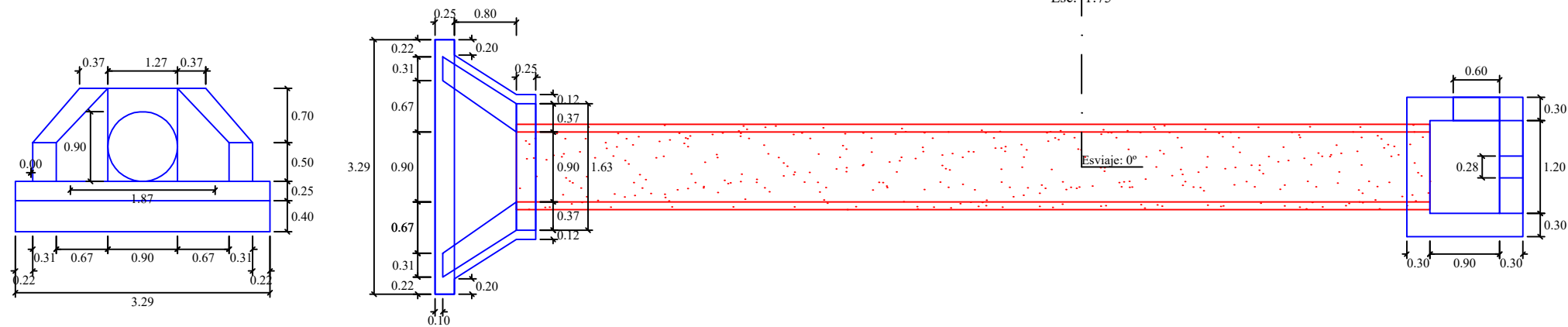

VISTA FRONTAL

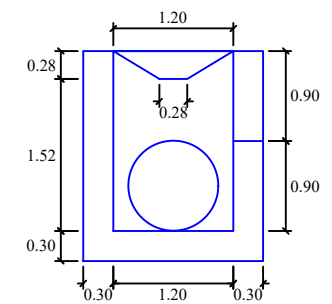

UNIVERSITARIO: BLADIMIR J. MARTINEZ MALLON

Proyecto:

DISEÑO DE INGENIERIA
TRAMO CARLAZO CENTRO - CARLAZO ESTE

DOCENTE: MARCELO H. PACHECO NUÑES

UNIVERSIDAD AUTONOMA JUAN MISAEL SARACHO
FACULTAD DE CIENCIAS Y TECNOLOGIA
CARRERA DE INGENIERIA CIVIL
ASIGNATURA: PROYECTO DE INGENIERIA CIVIL II CIV-502



Revisión:

OBRAS DE DRENAJE

ALCANTARILLA 1ATH Ø 0.9

PLANTA PERFIL

Prog.: 4+180

LAMINA: 7/11 ESCALA: INDICADA

PERFIL LONGITUDINAL

Esc. 1:100

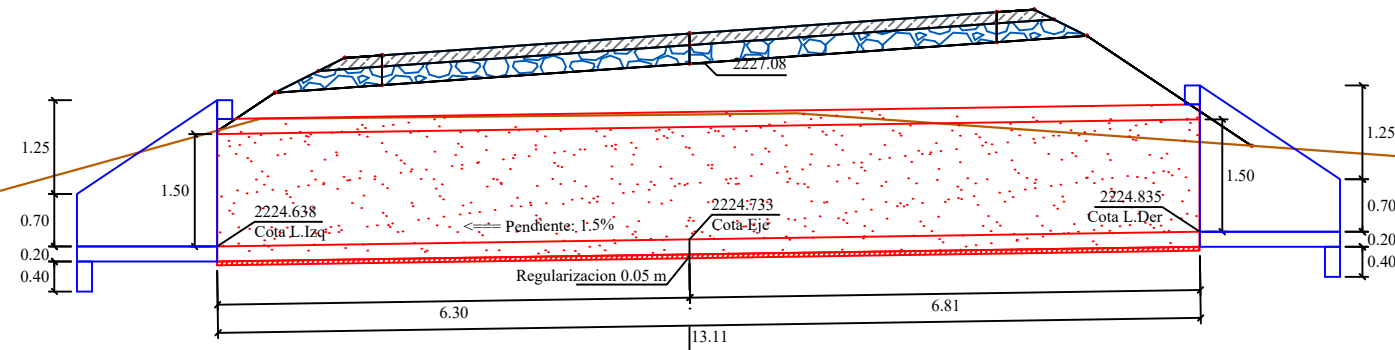

ALCANTARILLA	
Tipo.....	CAJON
Seccion....	DTC 2(1.5X1.5)
Esviaje....	0.00°
Pendiente..	1.50%
Longitud LI:	6.30
Longitud LD:	6.81
COTAS CONDUCTO	
Cota Izq.:	2224.638
Cota Eje.:	2224.733
Cota Der.:	2224.835

PLANTA

Esc. 1:100

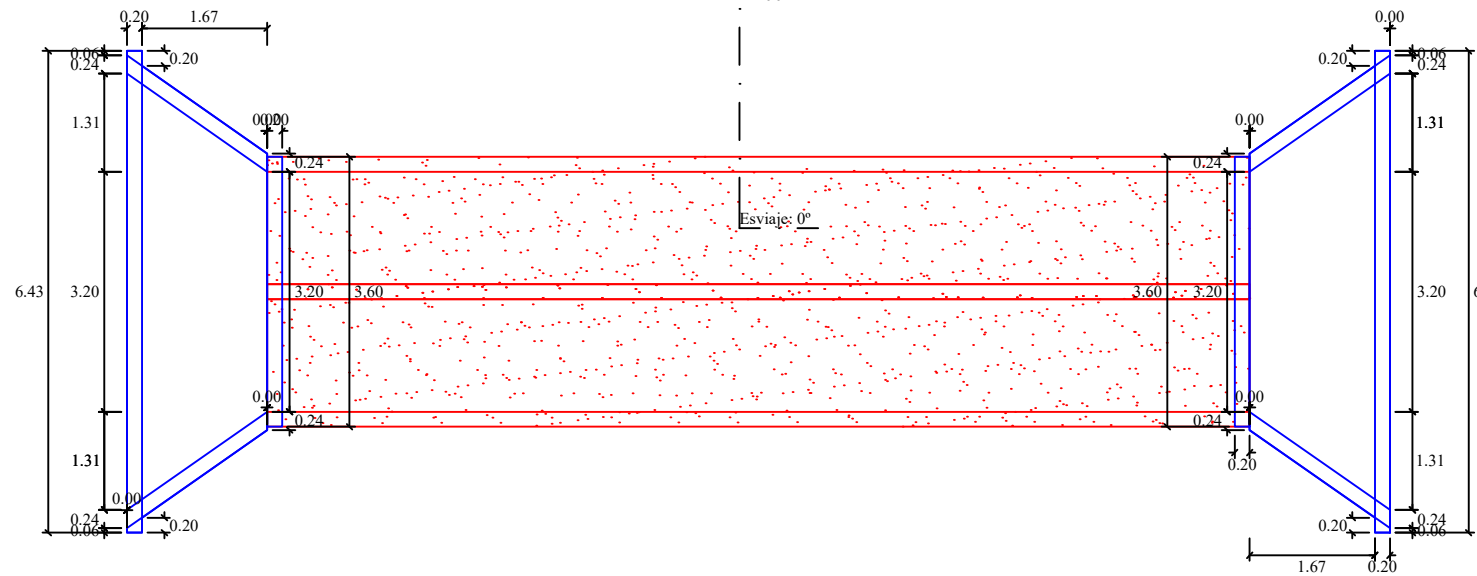

VISTA FRONTAL

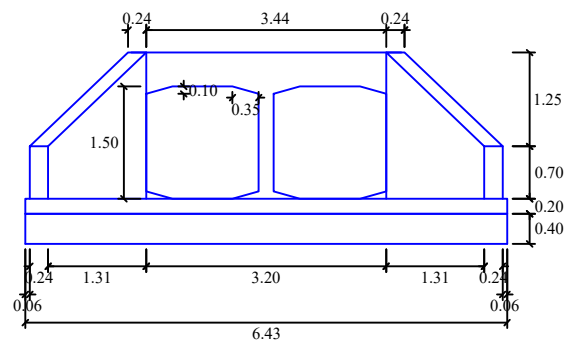

VISTA FRONTAL

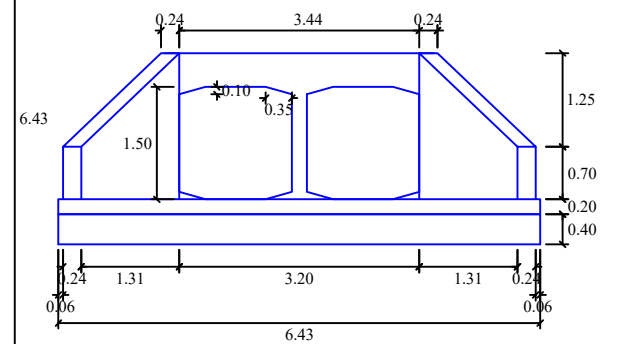

UNIVERSITARIO: BLADIMIR J. MARTINEZ MALLON

Proyecto:

DISEÑO DE INGENIERIA
TRAMO CARLAZO CENTRO - CARLAZO ESTE

DOCENTE: MARCELO H. PACHECO NUÑES

UNIVERSIDAD AUTONOMA JUAN MISAEL SARACHO
FACULTAD DE CIENCIAS Y TECNOLOGIA
CARRERA DE INGENIERIA CIVIL
ASIGNATURA: PROYECTO DE INGENIERIA CIVIL II CIV-502



Revisión:

OBRAS DE DRENAJE

ALCANTARILLA DTC 2(1.5X1.5)

PLANTA PERFIL

Prog.: 4+531

LAMINA: 8/11
ESCALA: INDICADA

PERFIL LONGITUDINAL
Esc. 1:75

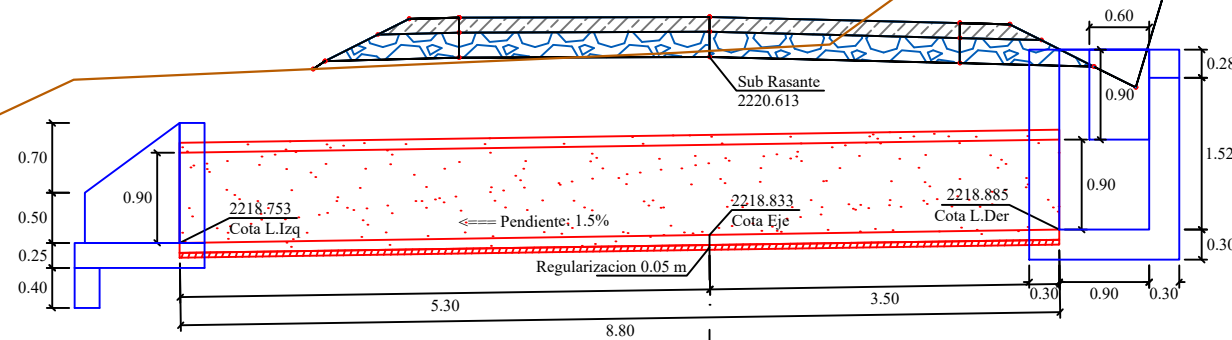

ALCANTARILLA	
Tipo.....:	TUBO
Seccion...:	1ATH Ø 0.9
Esviaje....:	0.00°
Pendiente..:	1.50%
Longitud LI.:	5.30
Longitud LD.:	3.50
COTAS CONDUCTO	
Cota Izq.:	2218.753
Cota Eje.:	2218.833
Cota Der.:	2218.885

PLANTA
Esc. 1:75

VISTA FRONTAL

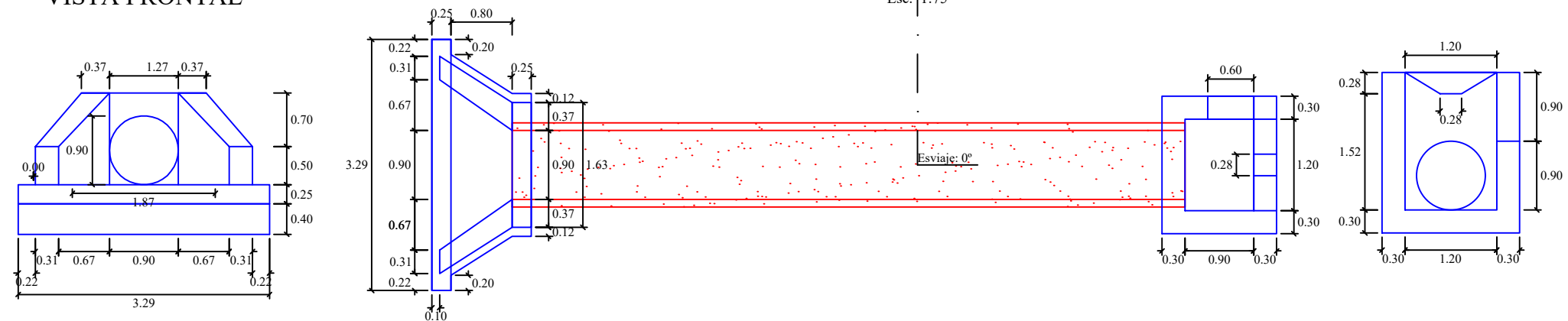

UNIVERSITARIO: BLADIMIR J. MARTINEZ MALLON

Proyecto:

DISEÑO DE INGENIERIA
TRAMO CARLAZO CENTRO - CARLAZO ESTE

DOCENTE: MARCELO H. PACHECO NUÑES

UNIVERSIDAD AUTONOMA JUAN MISAEL SARACHO
FACULTAD DE CIENCIAS Y TECNOLOGIA
CARRERA DE INGENIERIA CIVIL
ASIGNATURA: PROYECTO DE INGENIERIA CIVIL II CIV-502



Revisión:

OBRAS DE DRENAJE

ALCANTARILLA 1ATH Ø 0.9

PLANTA PERFIL

Prog.: 4+760

LAMINA:	ESCALA:
9/11	INDICADA

PERFIL LONGITUDINAL

Esc. 1:75

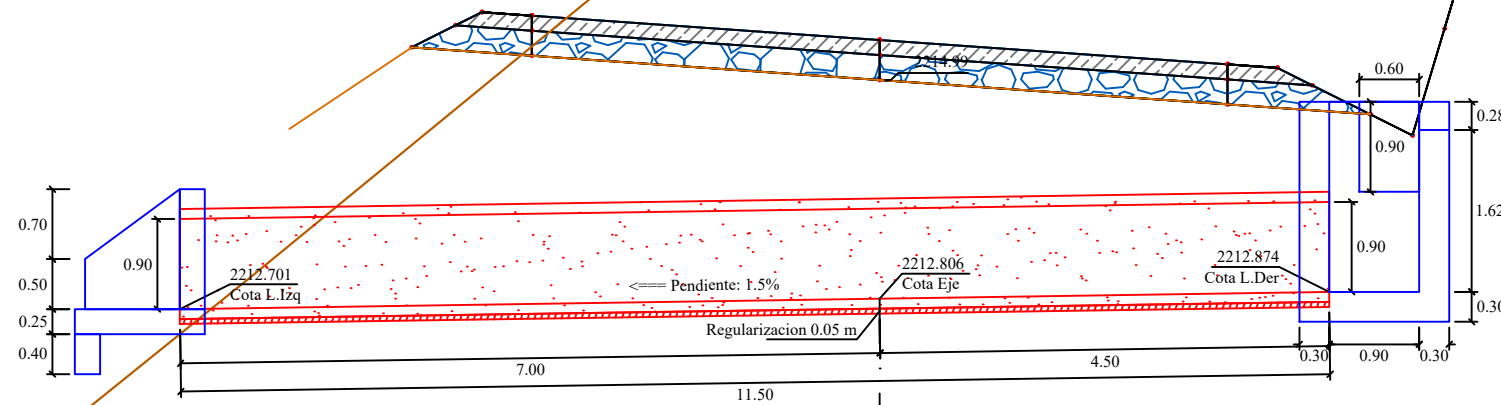

ALCANTARILLA	
Tipo.....:	TUBO
Seccion...:	1ATH Ø 0.9
Esviaje....:	0.00°
Pendiente.:	1.50%
Longitud LI.:	7.00
Longitud LD.:	4.50
COTAS CONDUCTO	
Cota Izq.:	2212.701
Cota Eje.:	2212.806
Cota Der.:	2212.874

PLANTA

Esc. 1:75

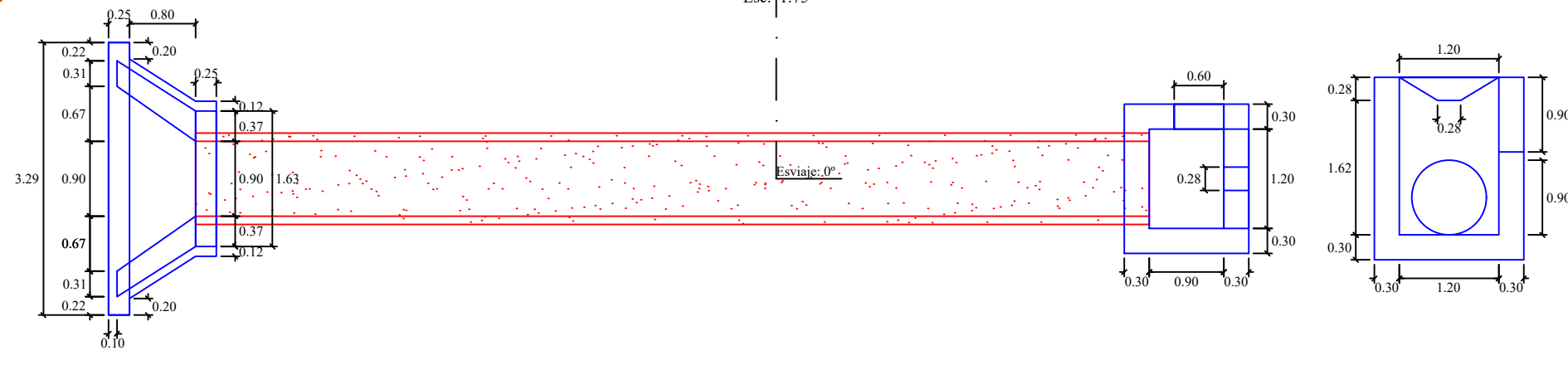

VISTA FRONTAL

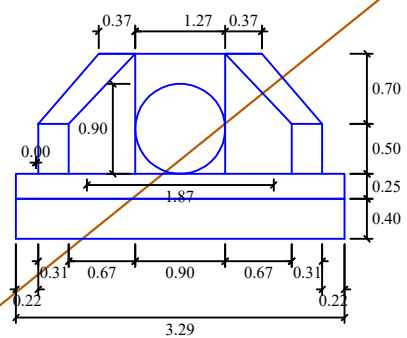

UNIVERSITARIO: BLADIMIR J. MARTINEZ MALLON

Proyecto:

DISEÑO DE INGENIERIA
TRAMO CARLAZO CENTRO - CARLAZO ESTE

DOCENTE: MARCELO H. PACHECO NUÑES

UNIVERSIDAD AUTONOMA JUAN MISAEL SARACHO
FACULTAD DE CIENCIAS Y TECNOLOGIA
CARRERA DE INGENIERIA CIVIL
ASIGNATURA: PROYECTO DE INGENIERIA CIVIL II CIV-502



Revisión:

OBRAS DE DRENAJE

ALCANTARILLA 1ATH Ø 0.9

PLANTA PERFIL

Prog.: 4+960

LAMINA:	ESCALA:
10/11	INDICADA

PERFIL LONGITUDINAL

Esc. 1:75

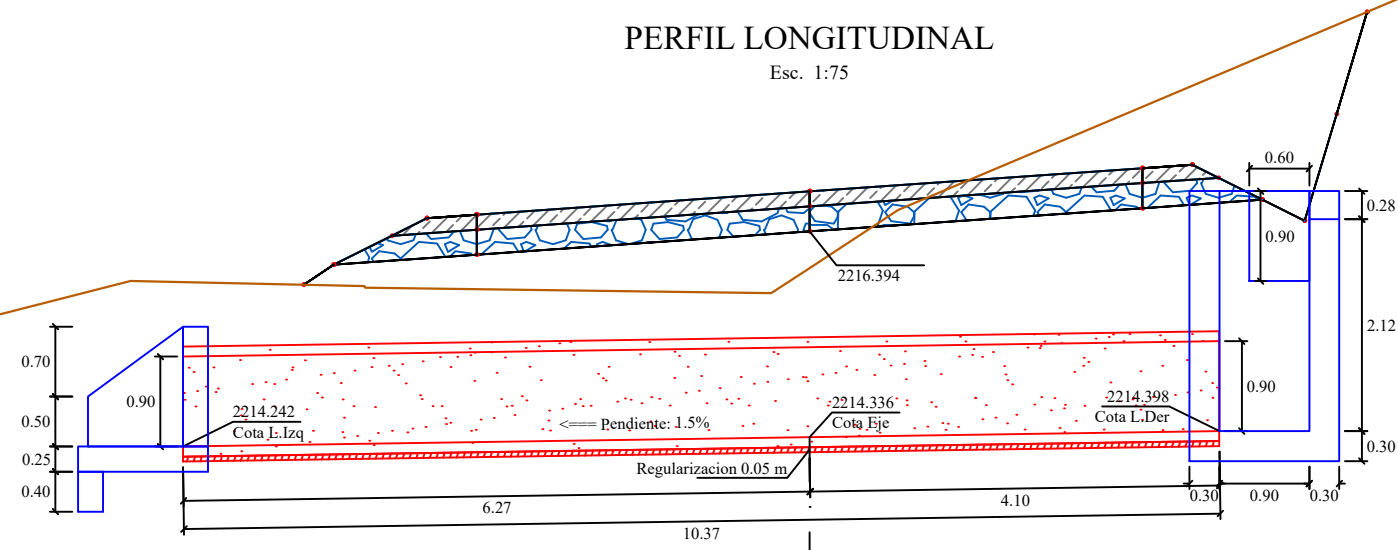

ALCANTARILLA	
Tipo.....:	TUBO
Seccion...:	1ATH Ø 0.9
Esviaje....:	0.00°
Pendiente.:	1.50%
Longitud LI.:	6.27
Longitud LD.:	4.10
COTAS CONDUCTO	
Cota Izq.:	2214.242
Cota Eje.:	2214.336
Cota Der.:	2214.398

PLANTA

Esc. 1:75

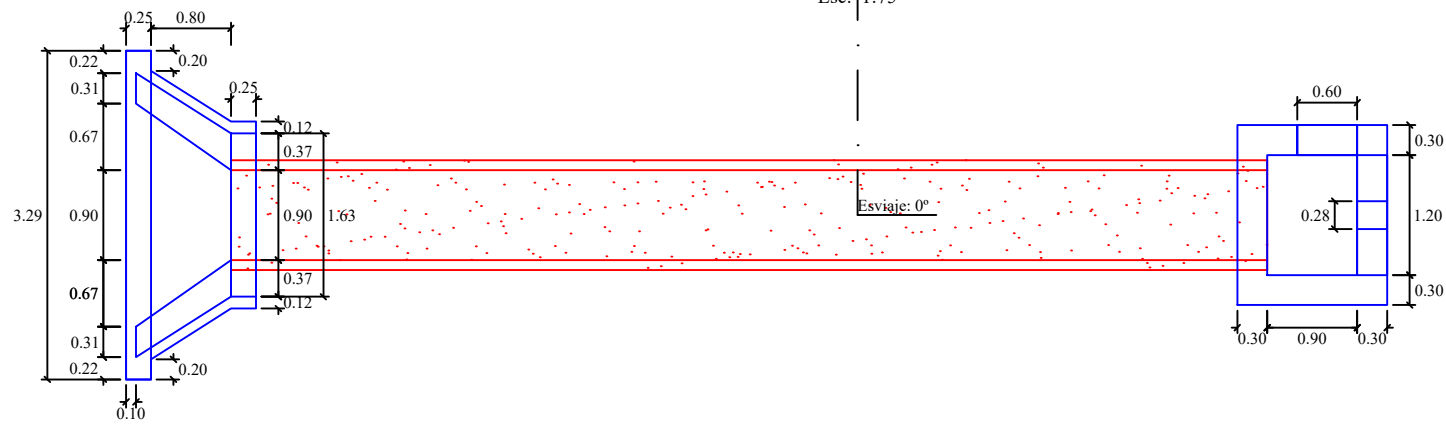

VISTA FRONTAL

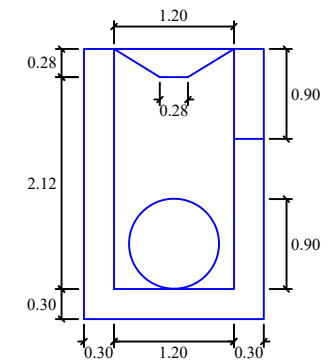
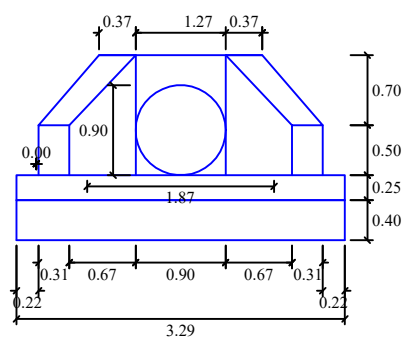

UNIVERSITARIO: BLADIMIR J. MARTINEZ MALLON

Proyecto:

DISEÑO DE INGENIERIA
TRAMO CARLAZO CENTRO - CARLAZO ESTE

DOCENTE: MARCELO H. PACHECO NUÑES

UNIVERSIDAD AUTONOMA JUAN MISAEL SARACHO
FACULTAD DE CIENCIAS Y TECNOLOGIA
CARRERA DE INGENIERIA CIVIL
ASIGNATURA: PROYECTO DE INGENIERIA CIVIL II CIV-502



Revisión:

OBRAS DE DRENAJE

ALCANTARILLA 1ATH Ø 0.9

PLANTA PERFIL

Prog.: 5+090

LAMINA:	ESCALA:
11/11	INDICADA