

# I.ES.

INSTALACIÓN ESPECIAL  
ESCALA 1 : 100

• **AUTOR**  
BIANCA MOLINA VALLEJOS

• **DOCENTE**  
ARO. LUIS JAVIER SÁNCHEZ

• **MATERIA**  
PROYECTO DE GRADO - 501

ARQUITECTURA  
URBANISMO  
FACULTAD DE CIENCIAS Y TECNOLOGÍAS

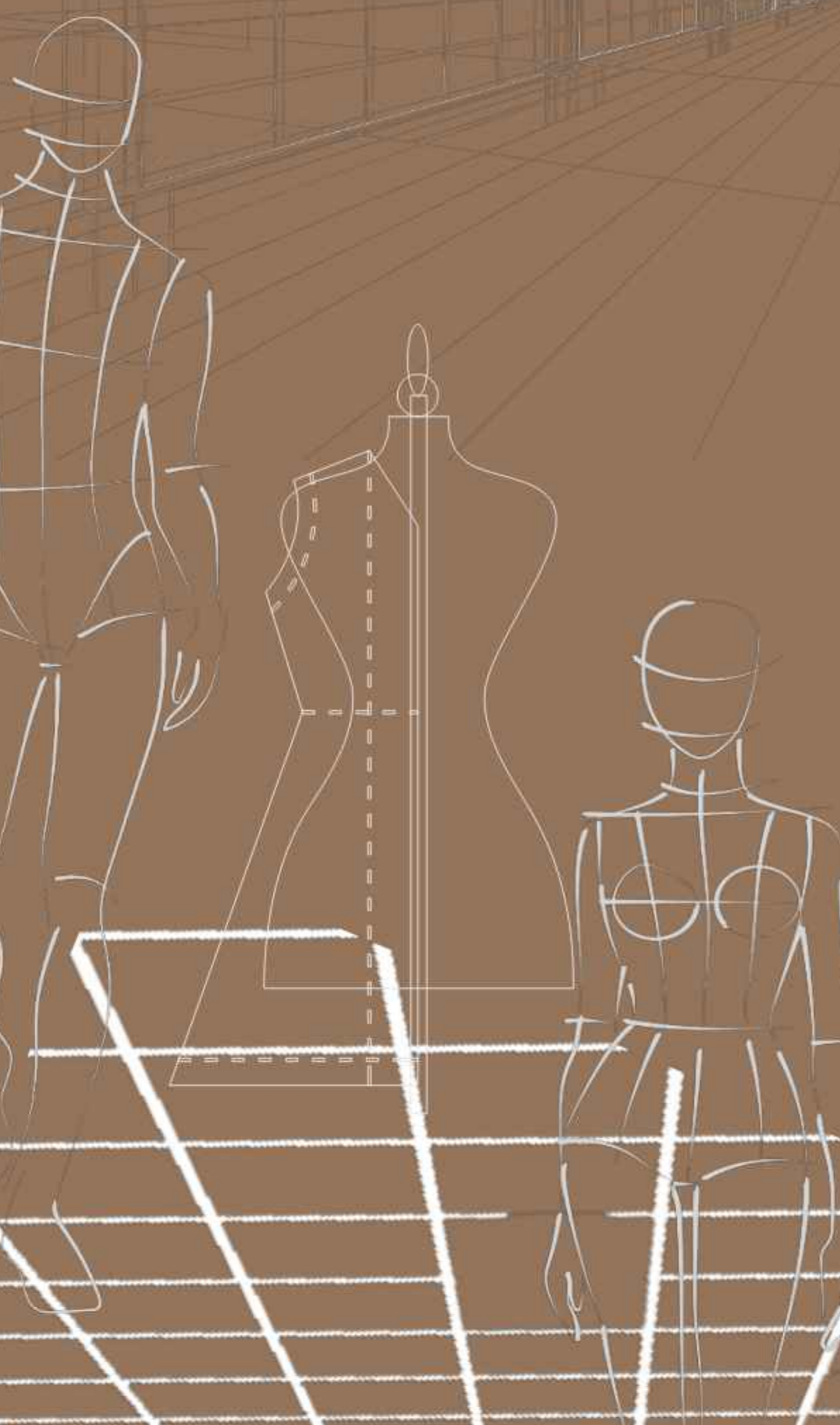

DISEÑO ARQUITECTÓNICO DEL MÓDULO PARA LA CREACIÓN DE LA CARRERA DE DISEÑO Y GESTIÓN DE LA MODA, DEPENDIENTE DE LA FACULTAD DE CIENCIAS Y TECNOLOGÍAS DE LA UAJMS. EN LA CIUDAD DE TARIJA

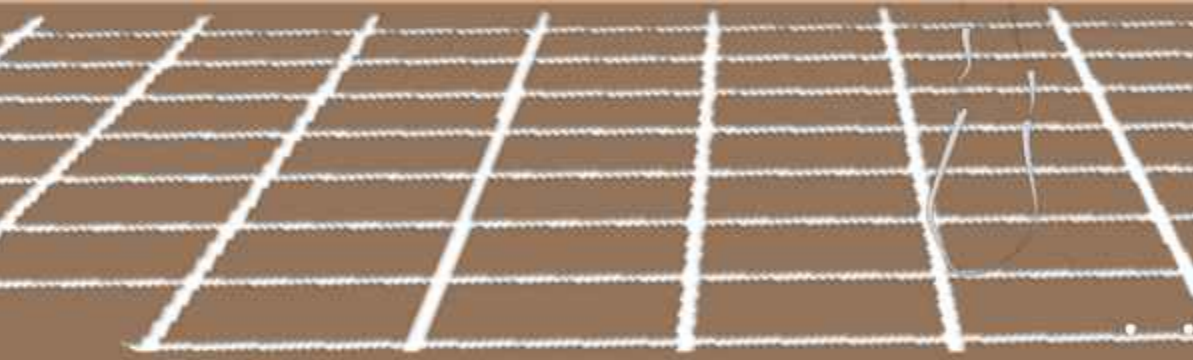

 **U.A.J.M.S.**  
2 0 2 2

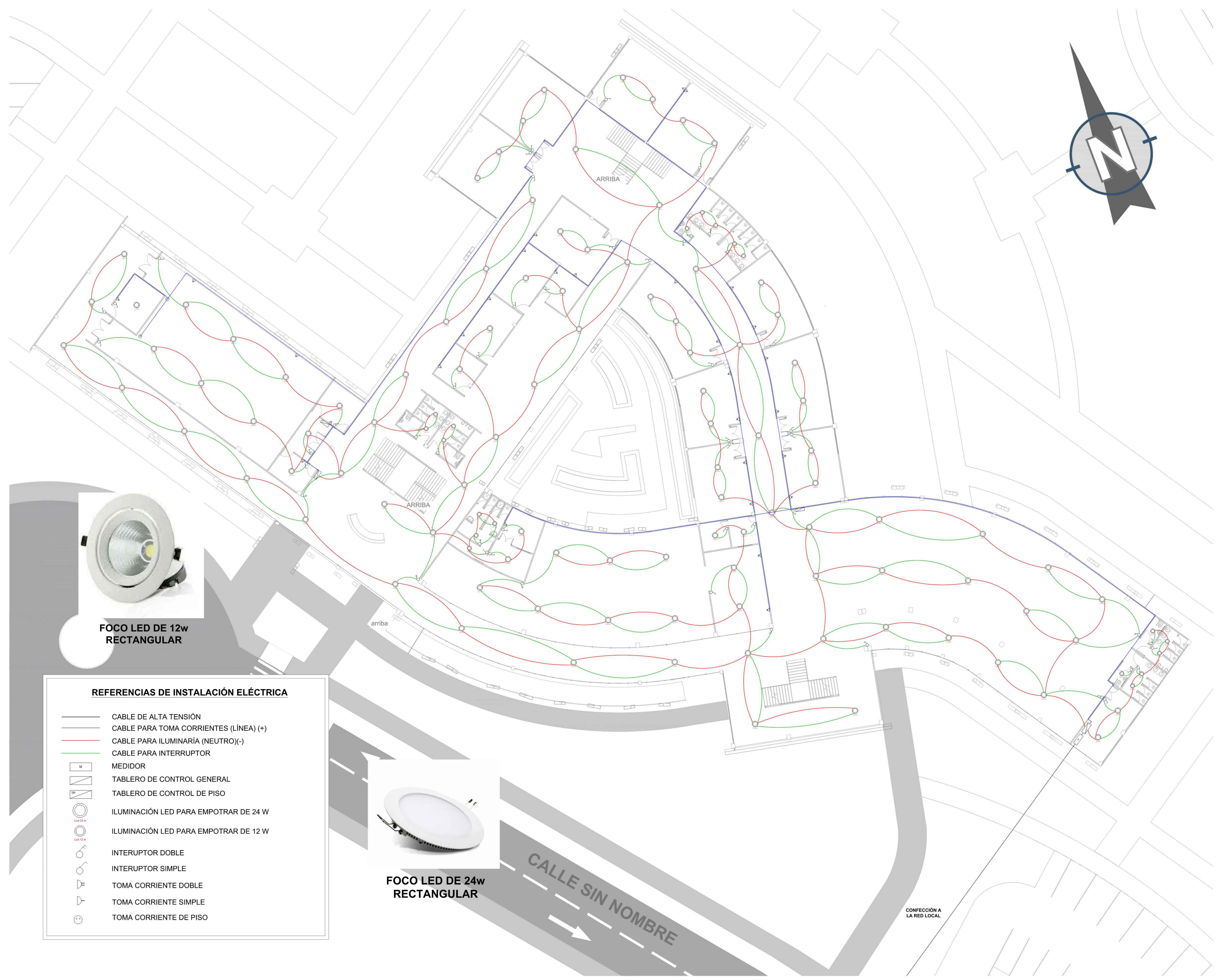
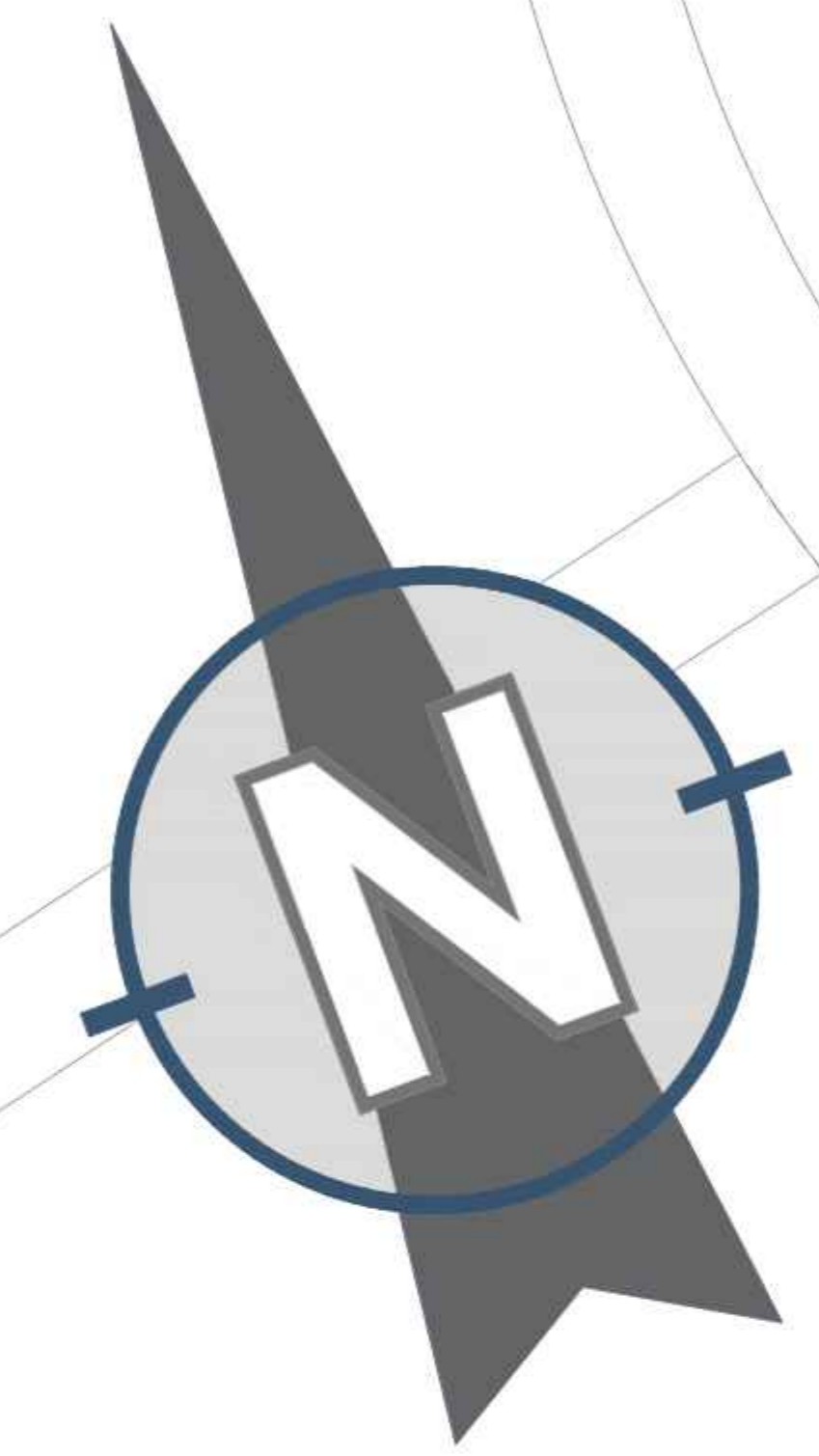















**FOCO LED DE 12w  
RECTANGULAR**



**FOCO LED DE 24w  
RECTANGULAR**

### REFERENCIAS DE INSTALACIÓN ELÉCTRICA

-  CABLE DE ALTA TENSION
-  CABLE PARA TOMA CORRIENTES (LÍNEA) (+)
-  CABLE PARA ILUMINARÍA (NEUTRO)(-)
-  CABLE PARA INTERRUPTOR
-  MEDIDOR
-  TABLERO DE CONTROL GENERAL
-  TABLERO DE CONTROL DE PISO
-  ILUMINACIÓN LED PARA EMPOTRAR DE 24 W
-  ILUMINACIÓN LED PARA EMPOTRAR DE 12 W
-  INTERRUPTOR DOBLE
-  INTERRUPTOR SIMPLE
-  TOMA CORRIENTE DOBLE
-  TOMA CORRIENTE SIMPLE
-  TOMA CORRIENTE DE PISO

CONFECCIÓN A LA RED LOCAL



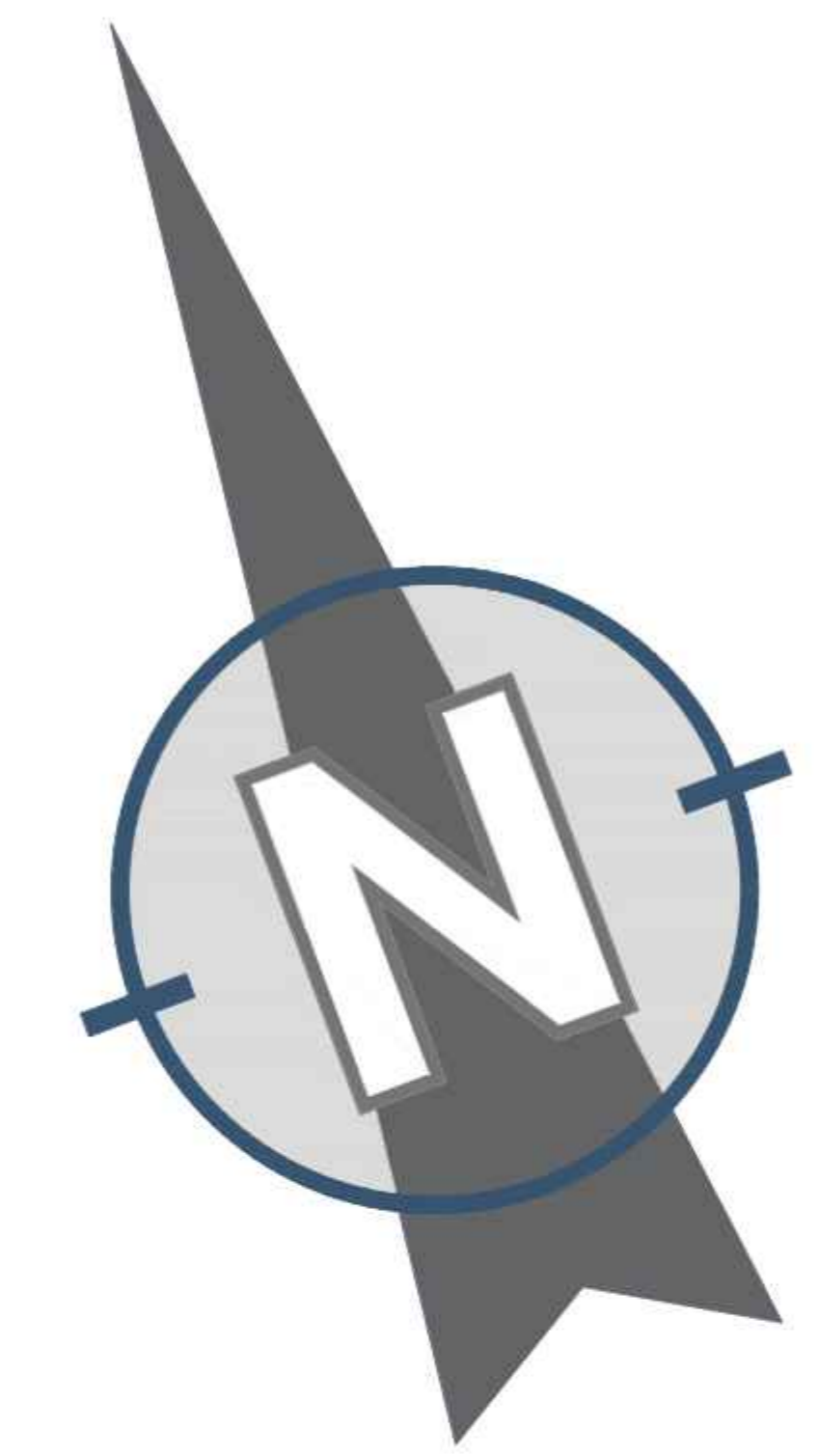











**FOCO LED DE 12w  
RECTANGULAR**

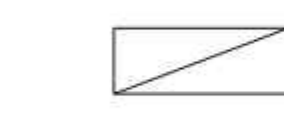
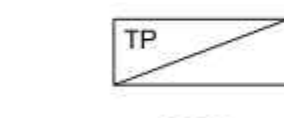
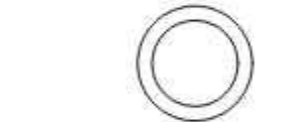

**FOCO LED DE 24w  
RECTANGULAR**

**REFERENCIAS DE INSTALACIÓN ELÉCTRICA**

-  CABLE DE ALTA TENSION
-  CABLE PARA TOMA CORRIENTES (LÍNEA) (+)
-  CABLE PARA ILUMINARÍA (NEUTRO)(-)
-  CABLE PARA INTERRUPTOR
-  MEDIDOR
-  TABLERO DE CONTROL GENERAL
-  TABLERO DE CONTROL DE PISO
-  ILUMINACIÓN LED PARA EMPOTRAR DE 24 W
-  ILUMINACIÓN LED PARA EMPOTRAR DE 12 W
-  INTERRUPTOR DOBLE
-  INTERRUPTOR SIMPLE
-  TOMA CORRIENTE DOBLE
-  TOMA CORRIENTE SIMPLE
-  TOMA CORRIENTE DE PISO

**I.ES.**

INSTALACIÓN ESPECIAL  
ESCALA 1 : 100

• **AUTOR**  
BIANCA MOLINA VALLEJOS

• **DOCENTE**  
ARO. LUIS JAVIER SÁNCHEZ

• **MATERIA**  
PROYECTO DE GRADO - 501

**ARQUITECTURA  
URBANISMO**  
FACULTAD DE CIENCIAS Y TECNOLOGÍAS

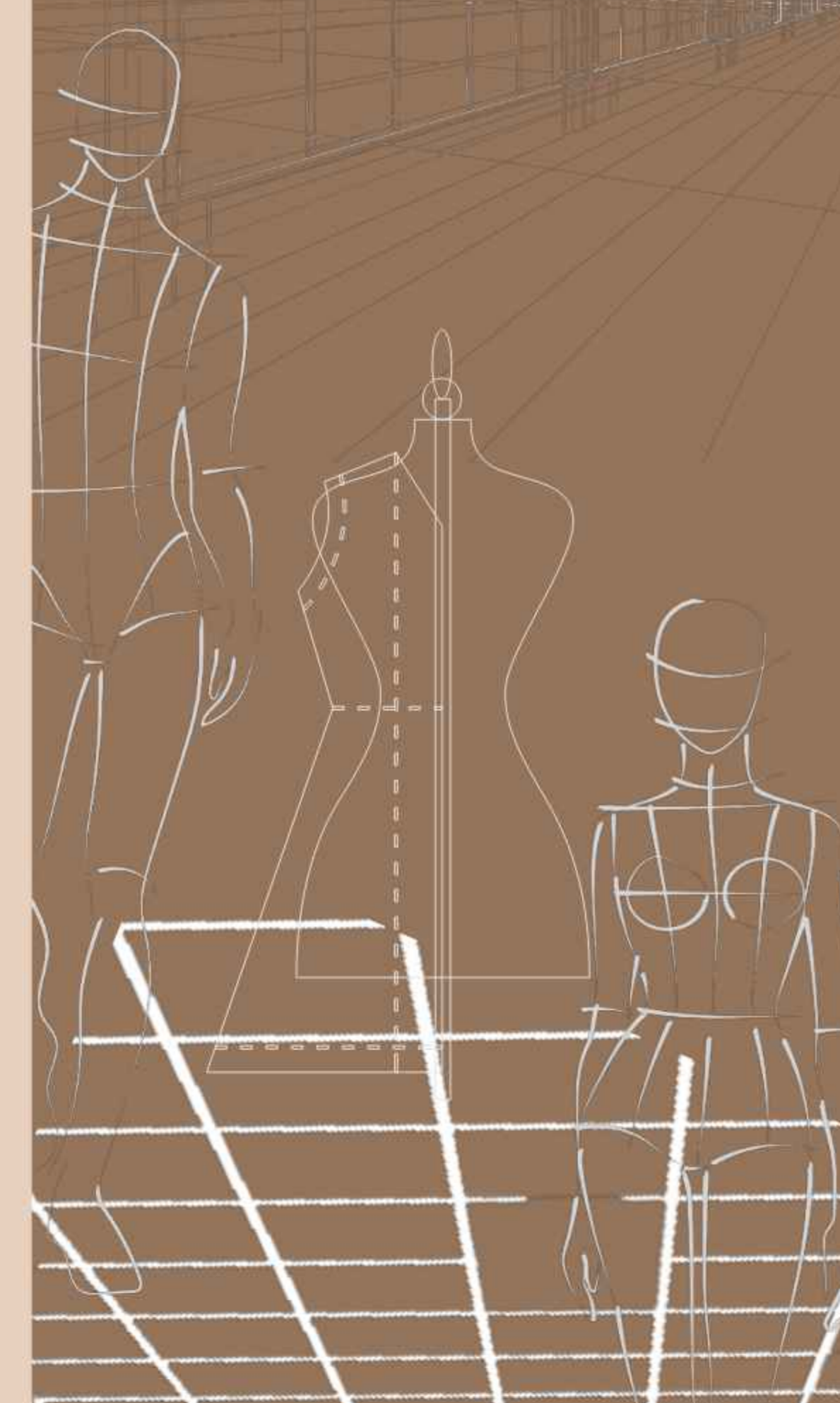

**D**ISEÑO ARQUITECTÓNICO DEL MÓDULO PARA LA CREACIÓN DE LA CARRERA DE DISEÑO Y GESTIÓN DE LA MODA, DEPENDIENTE DE LA FACULTAD DE CIENCIAS Y TECNOLOGÍAS DE LA UAJMS EN LA CIUDAD DE TARAJA



**U.A.J.M.S.**  
2022





# I.S.

INSTALACION SANITARIA  
ESCALA 1 : 100

- **AUTOR**  
BIANCA MOLINA VALLEJOS
- **DOCENTE**  
ARO. LUIS JAVIER SANCHEZ
- **MATERIA**  
PROYECTO DE GRADO - 501

**ARQUITECTURA  
URBANISMO**  
FACULTAD DE CIENCIAS Y TECNOLOGIAS

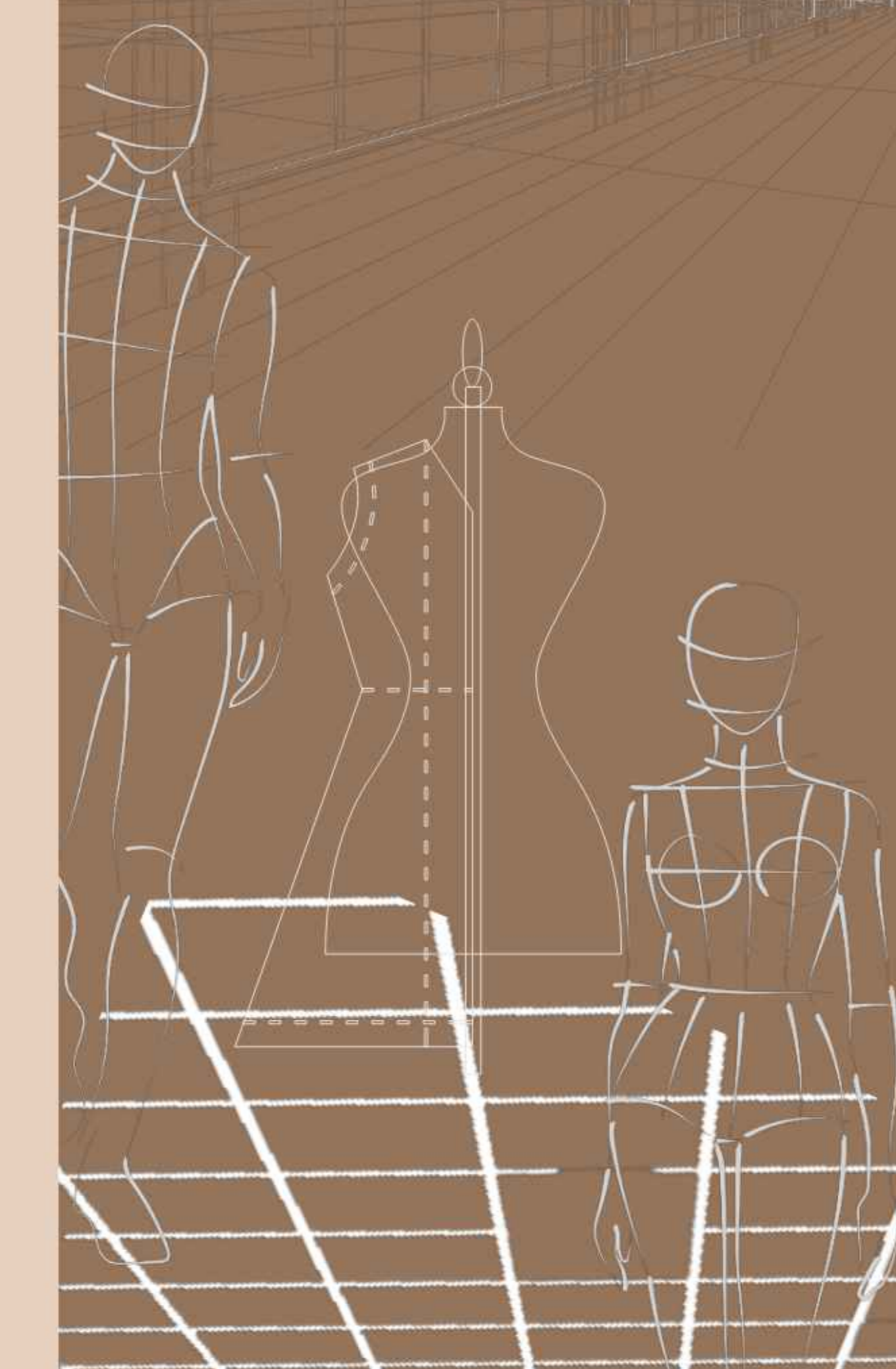

**D**ISEÑO ARQUITECTÓNICO DEL MÓDULO PARA LA CREACIÓN DE LA CARRERA DE DISEÑO Y GESTIÓN DE LA MODA, DEPENDIENTE DE LA FACULTAD DE CIENCIAS Y TECNOLOGÍAS DE LA UAJMS. EN LA CIUDAD DE TARAJA.



**U.A.J.M.S.**  
2 0 2 2







# I.S.

INSTALACION SANITARIA  
ESCALA 1 : 100

- **AUTOR**  
BIANCA MOLINA VALLEJOS
- **DOCENTE**  
ARO. LUIS JAVIER SÁNCHEZ
- **MATERIA**  
PROYECTO DE GRADO - 501

**ARQUITECTURA  
URBANISMO**  
FACULTAD DE CIENCIAS Y TECNOLOGÍAS

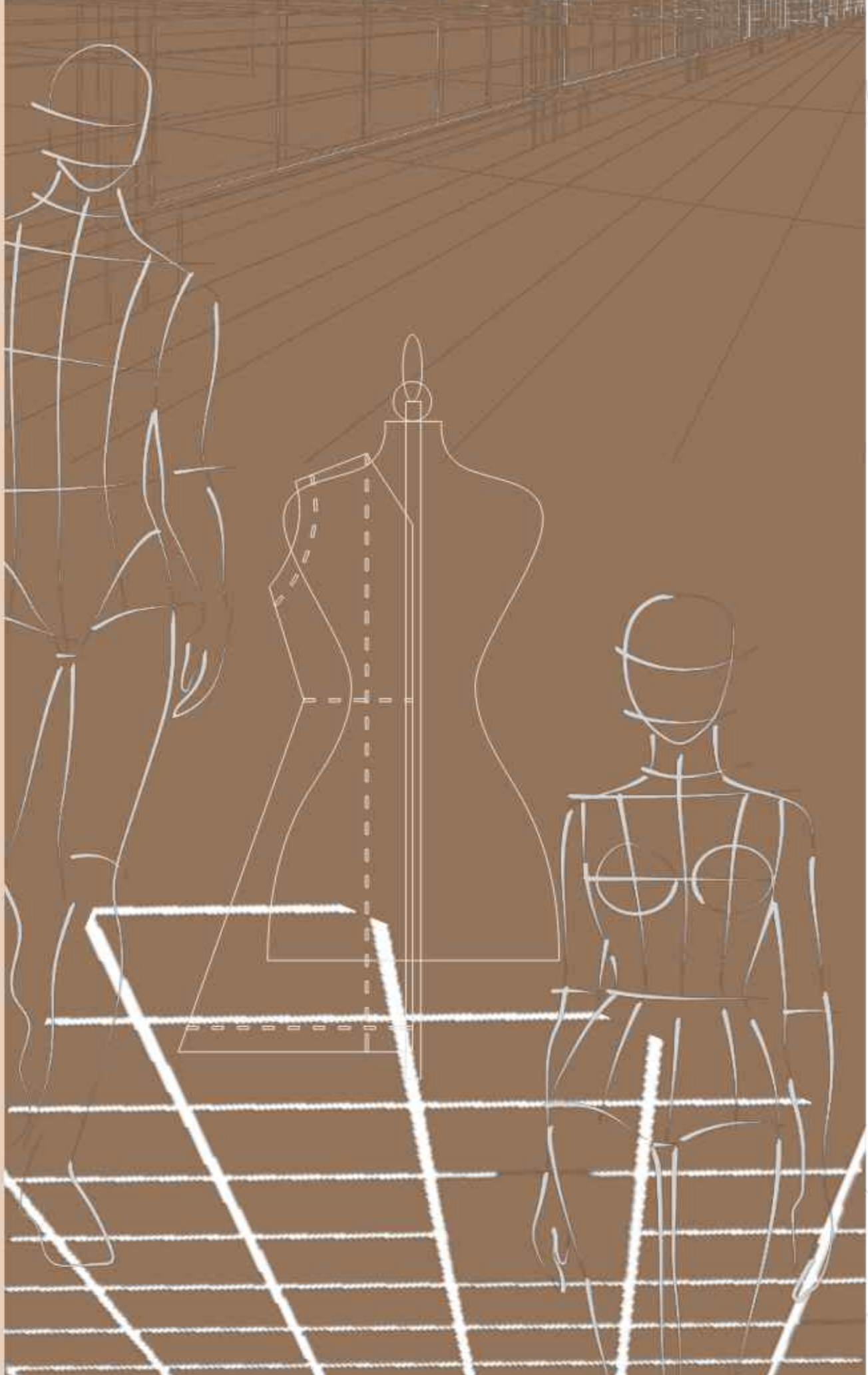

**D**ISEÑO ARQUITECTÓNICO DEL MÓDULO PARA LA CREACIÓN DE LA CARRERA DE DISEÑO Y GESTIÓN DE LA MODA, DEPENDIENTE DE LA FACULTAD DE CIENCIAS Y TECNOLOGÍAS DE LA UAJMS. EN LA CIUDAD DE TARAJA



**U.A.J.M.S.**  
2022



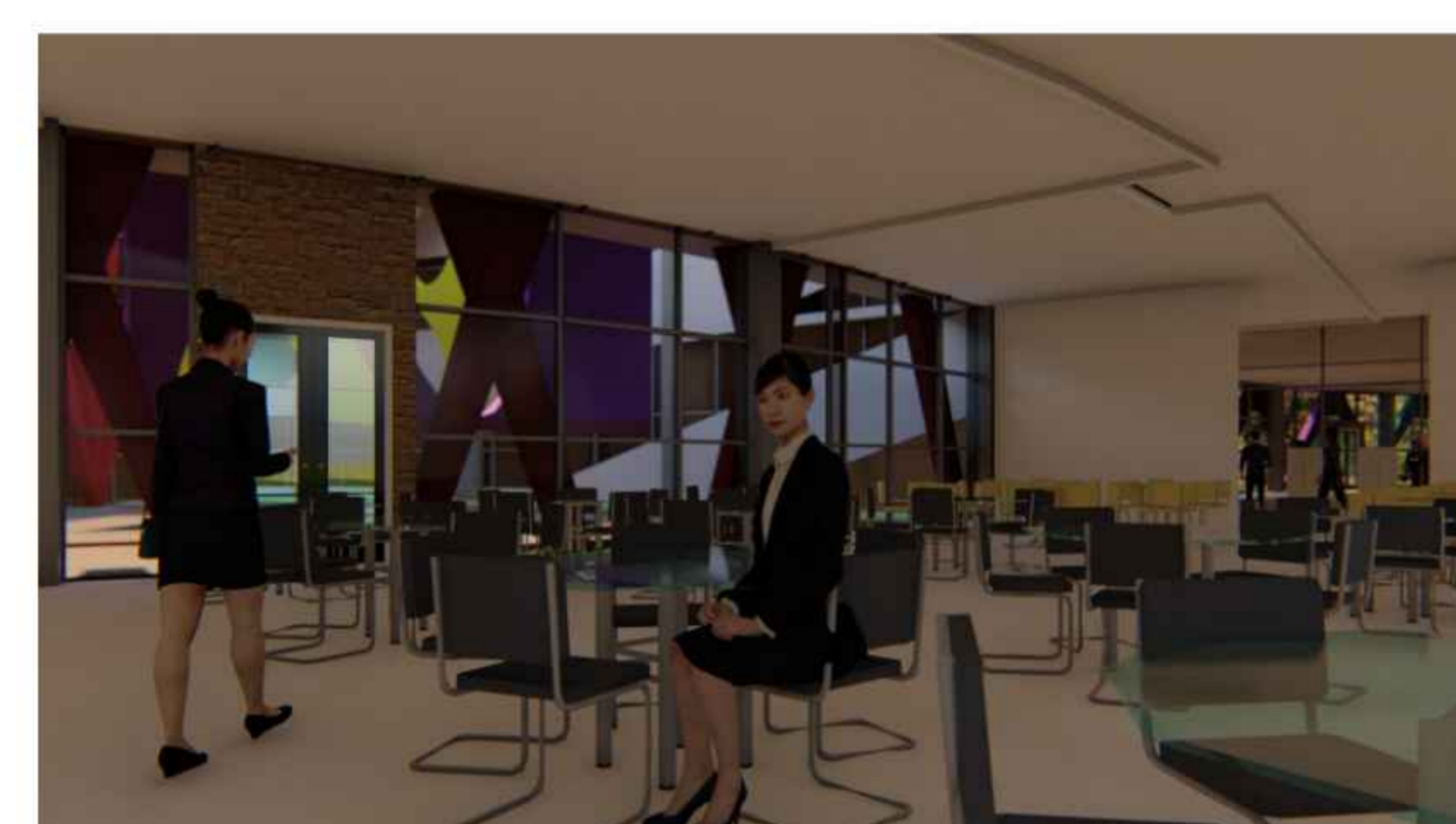

# P.I.E.

PERSPECTIVAS INT. - EXT.  
ESCALA 1 : 100

AUTOR  
BIANCA MOLINA VALLEJOS

DOCENTE  
ARO. LUIS JAVIER SÁNCHEZ

MATERIA  
PROYECTO DE GRADO - 501

ARQUITECTURA  
URBANISMO  
FACULTAD DE CIENCIAS Y TECNOLOGÍAS

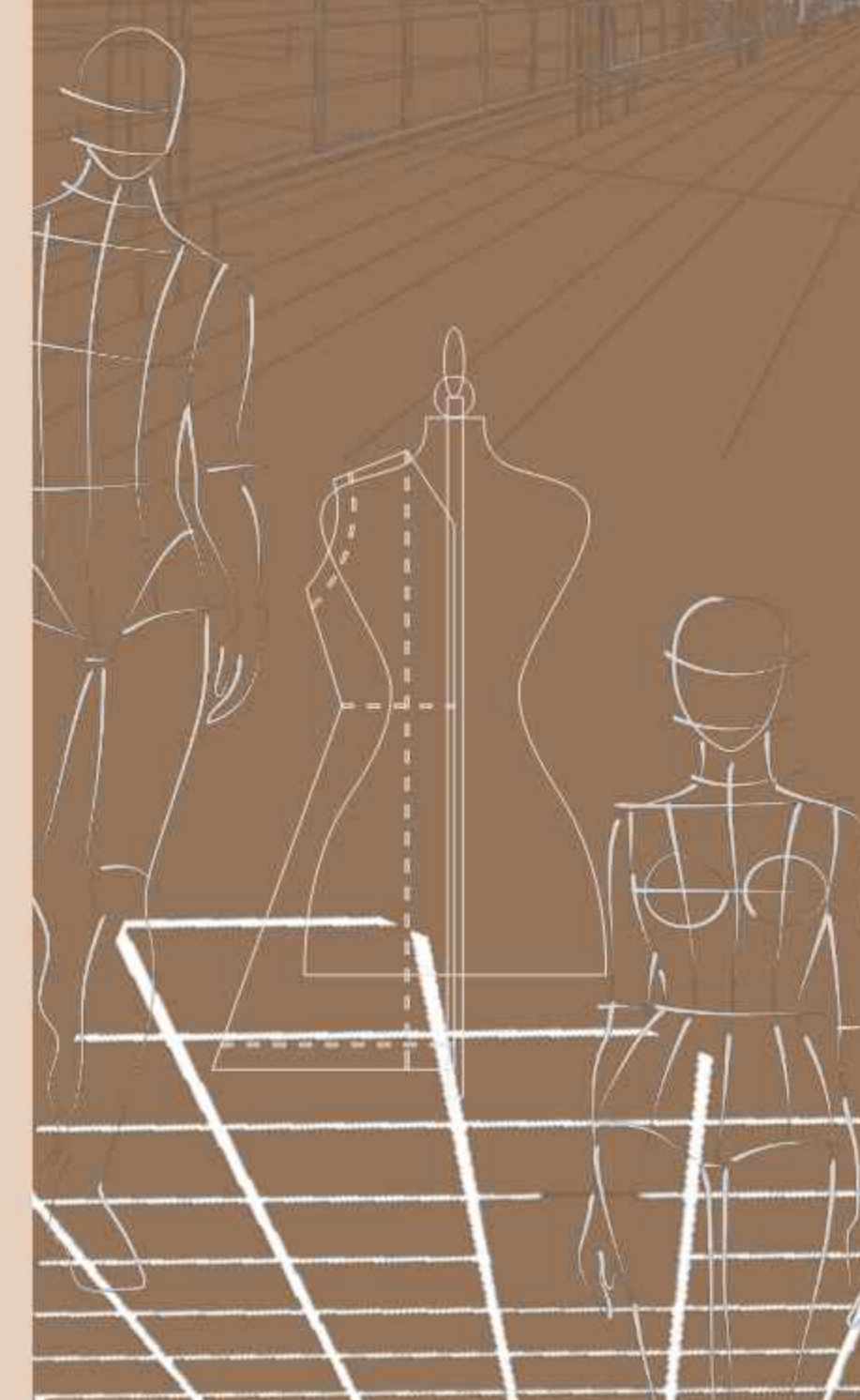

DISEÑO ARQUITECTÓNICO DEL MÓDULO  
PARA LA CREACIÓN DE LA CARRERA DE  
DISEÑO Y GESTIÓN DE LA MODA,  
DEPENDIENTE DE LA FACULTAD DE CIENCIAS  
Y TECNOLOGÍAS DE LA UAJMS, EN LA  
CIUDAD DE TARIJA



U.A.J.M.S.  
2022





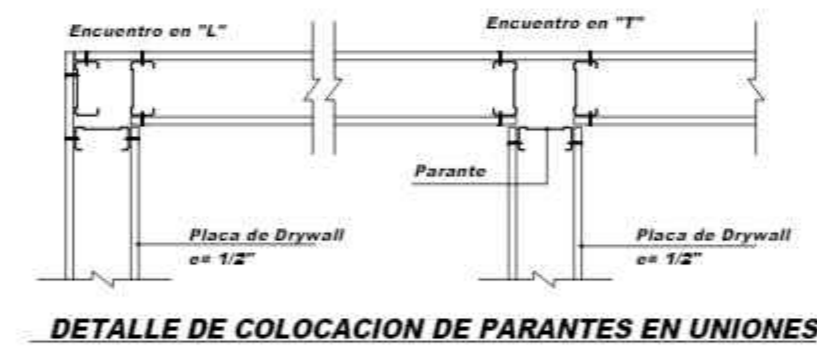
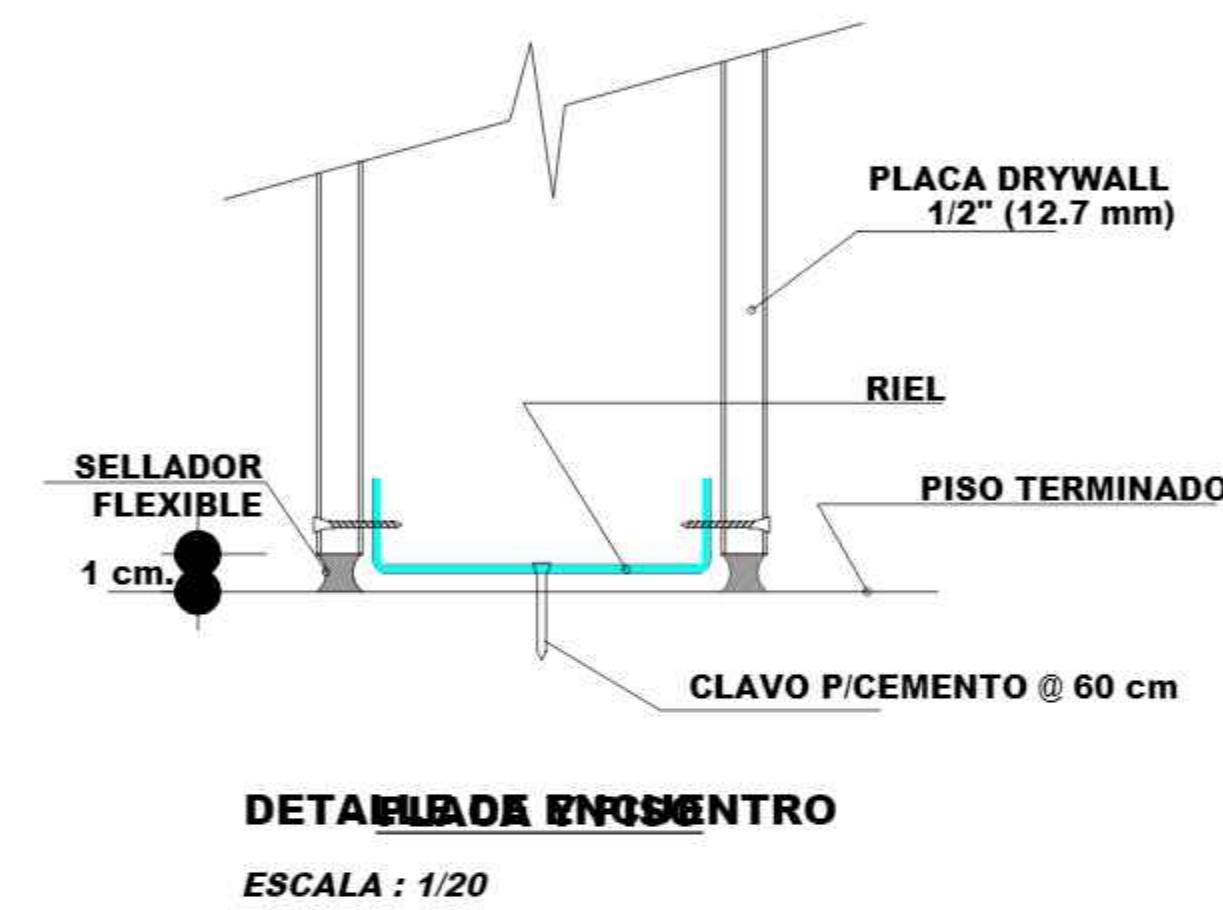
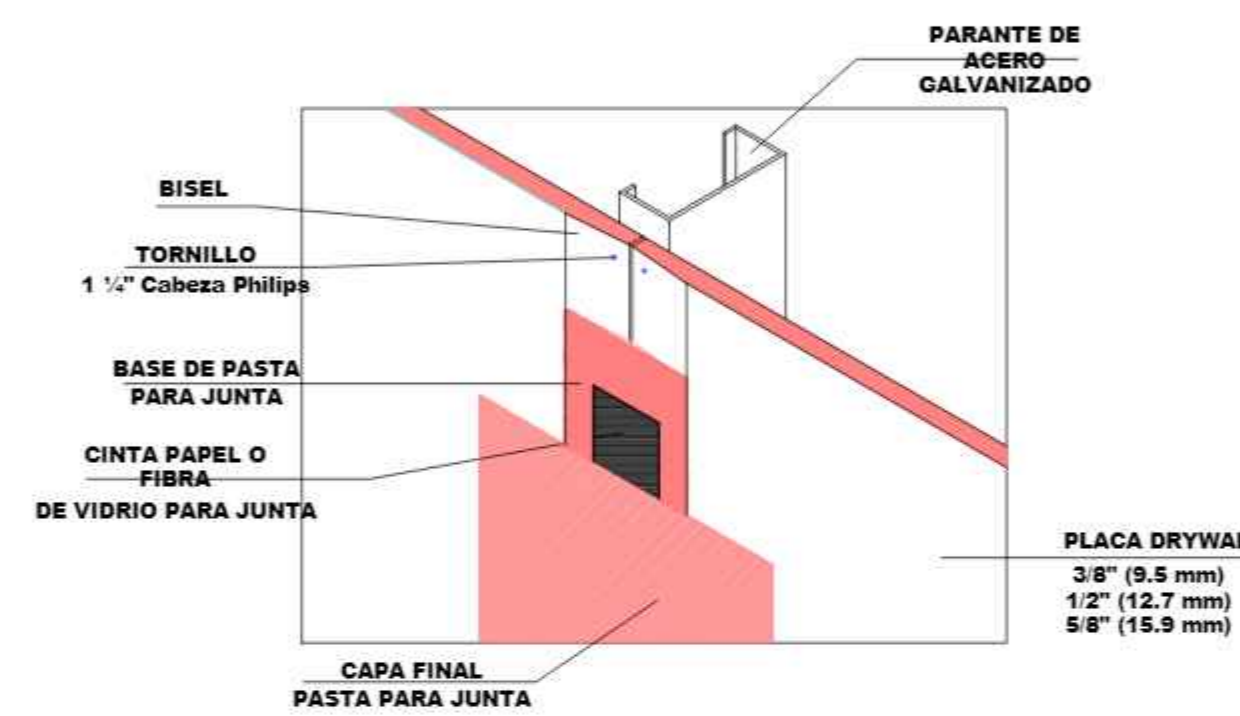
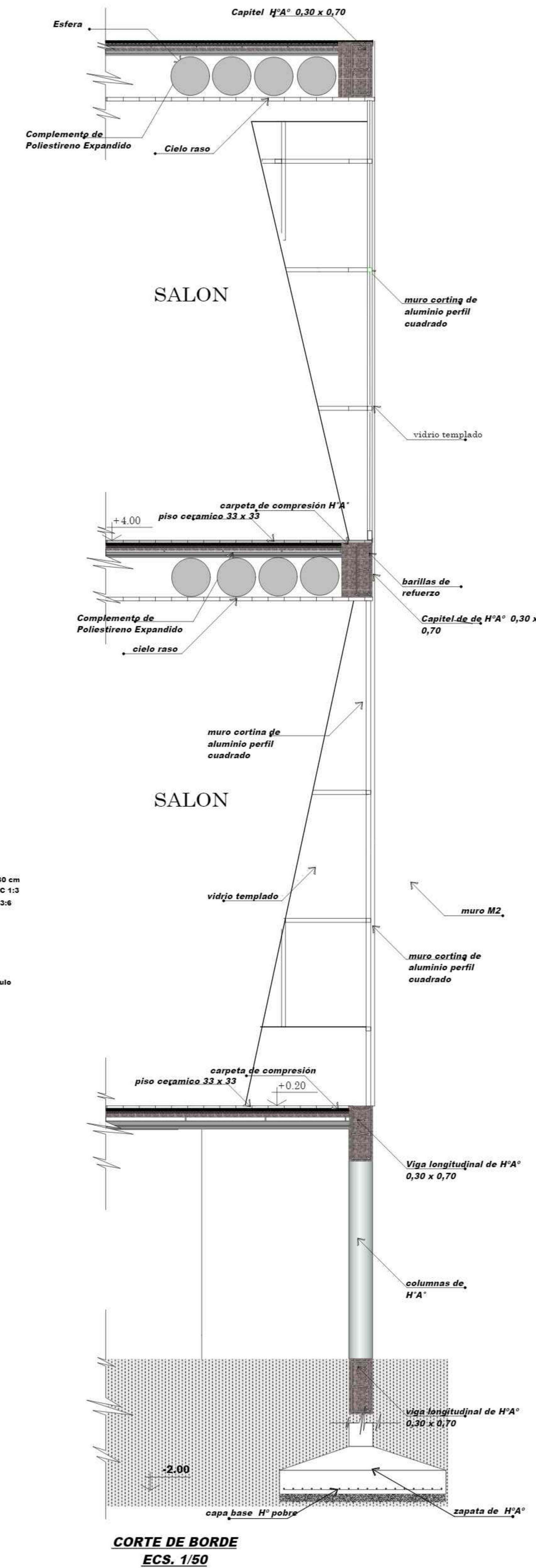
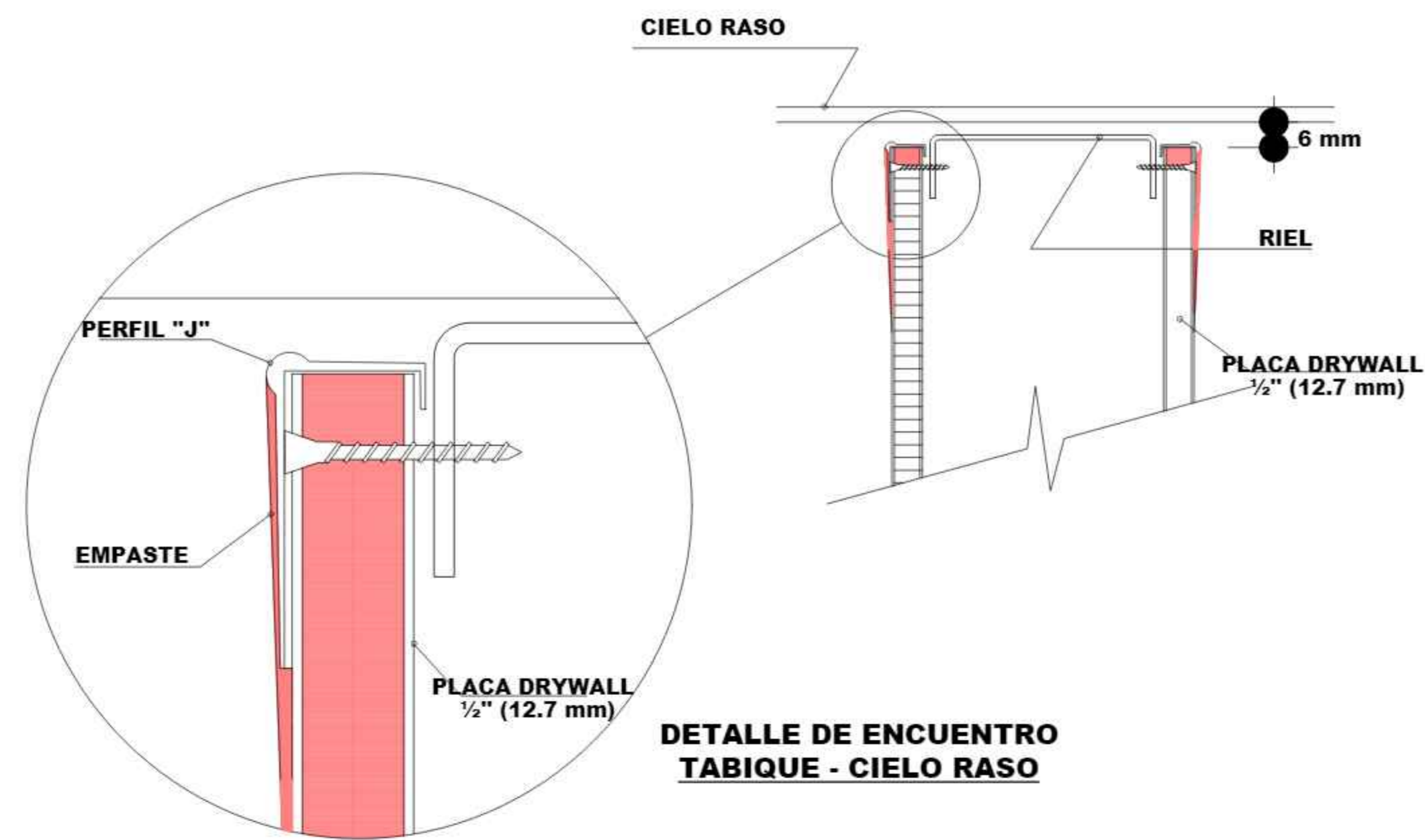
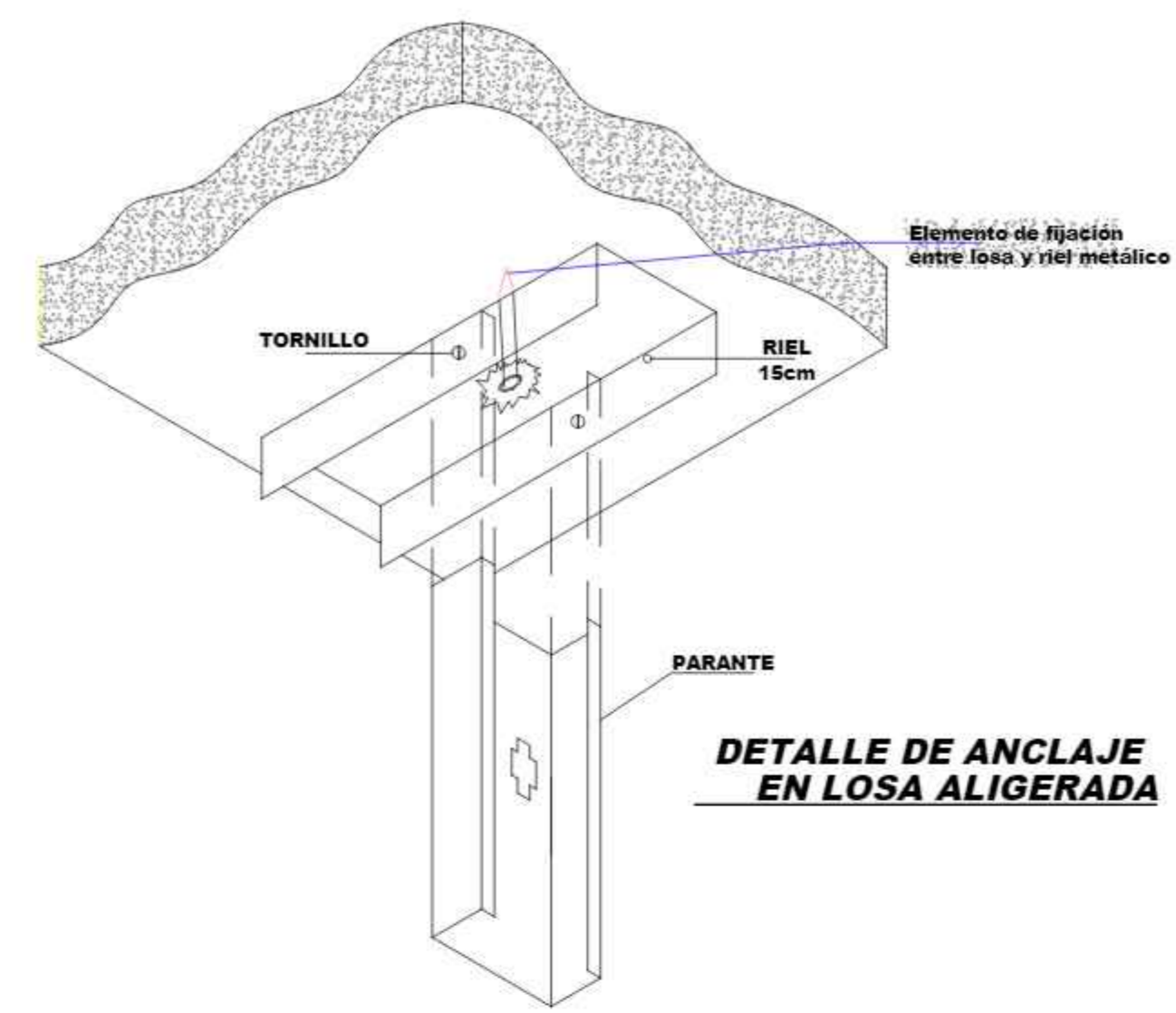

**DETALLE DE UNION DE PLANCHAS DRYWALL**

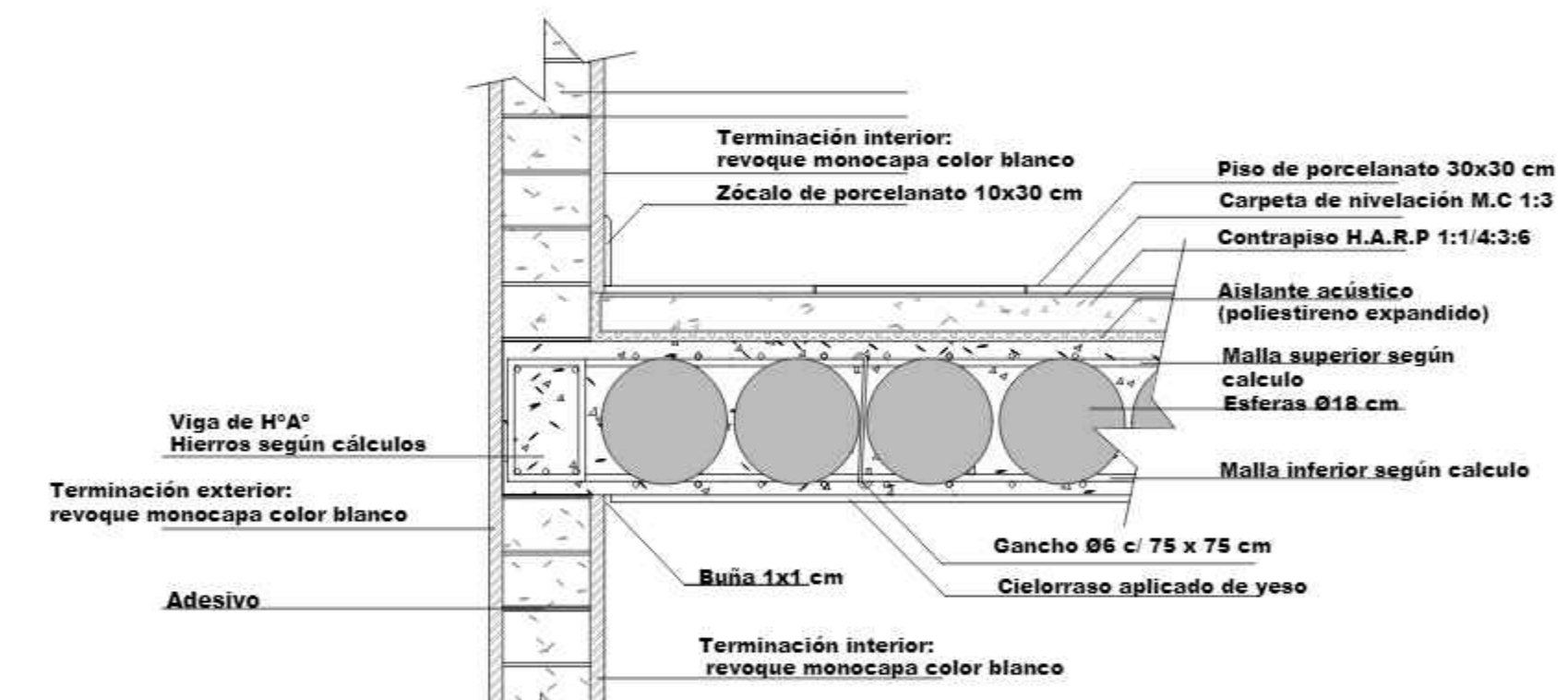
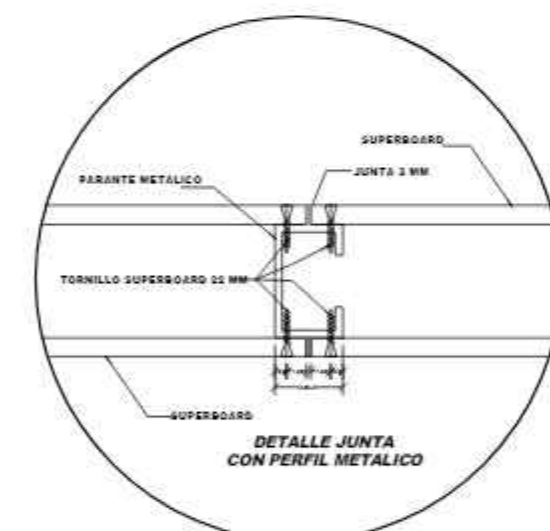

**DETALLE LOZA PRENOVA**  
**ESC. 1/10**

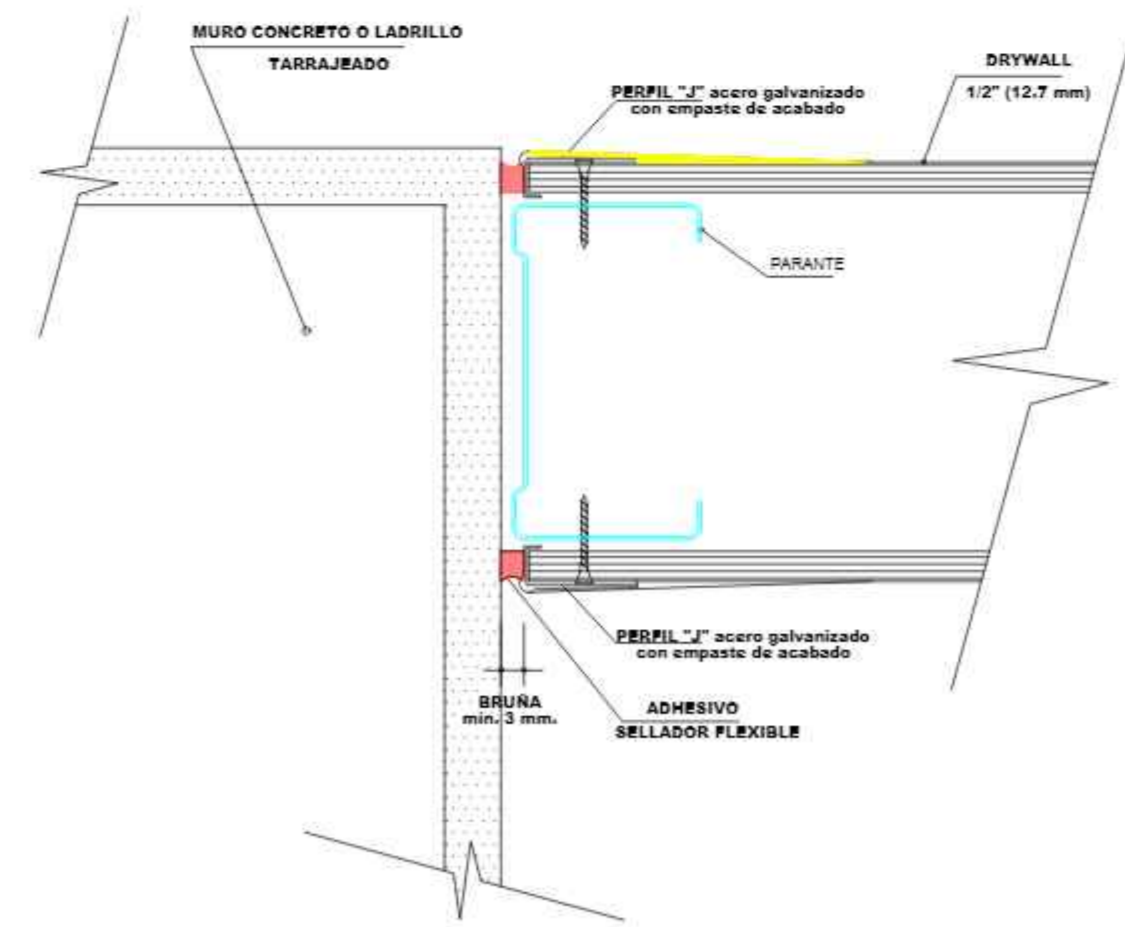

**DETALLE ENCUENTRO TABIQUE CONCRETO / TABIQUE DRYWALL**

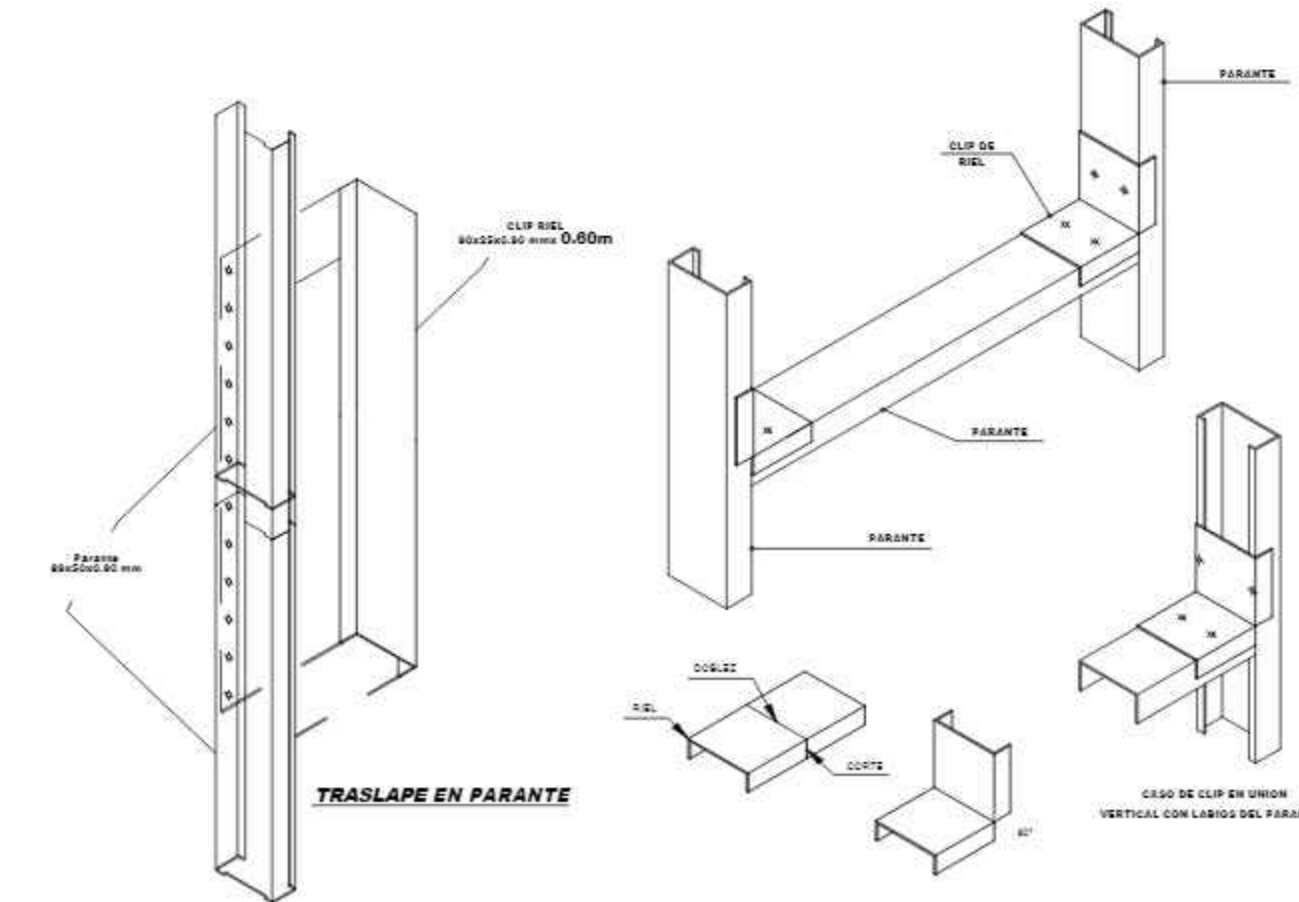

**DETALLE HORIZONTAL DE PERFILES**  
**ESC. 1/10**

**D.C.**

**DETALLE CONSTRUCTIVO**  
**ESCALA 1 : 100**

**AUTOR**  
BIANCA MOLINA VALLEJOS

**DOCENTE**  
ARO. LUIS JAVIER SÁNCHEZ

**MATERIA**  
PROYECTO DE GRADO - 501

**ARQUITECTURA URBANISMO**  
FACULTAD DE CIENCIAS Y TECNOLOGÍAS

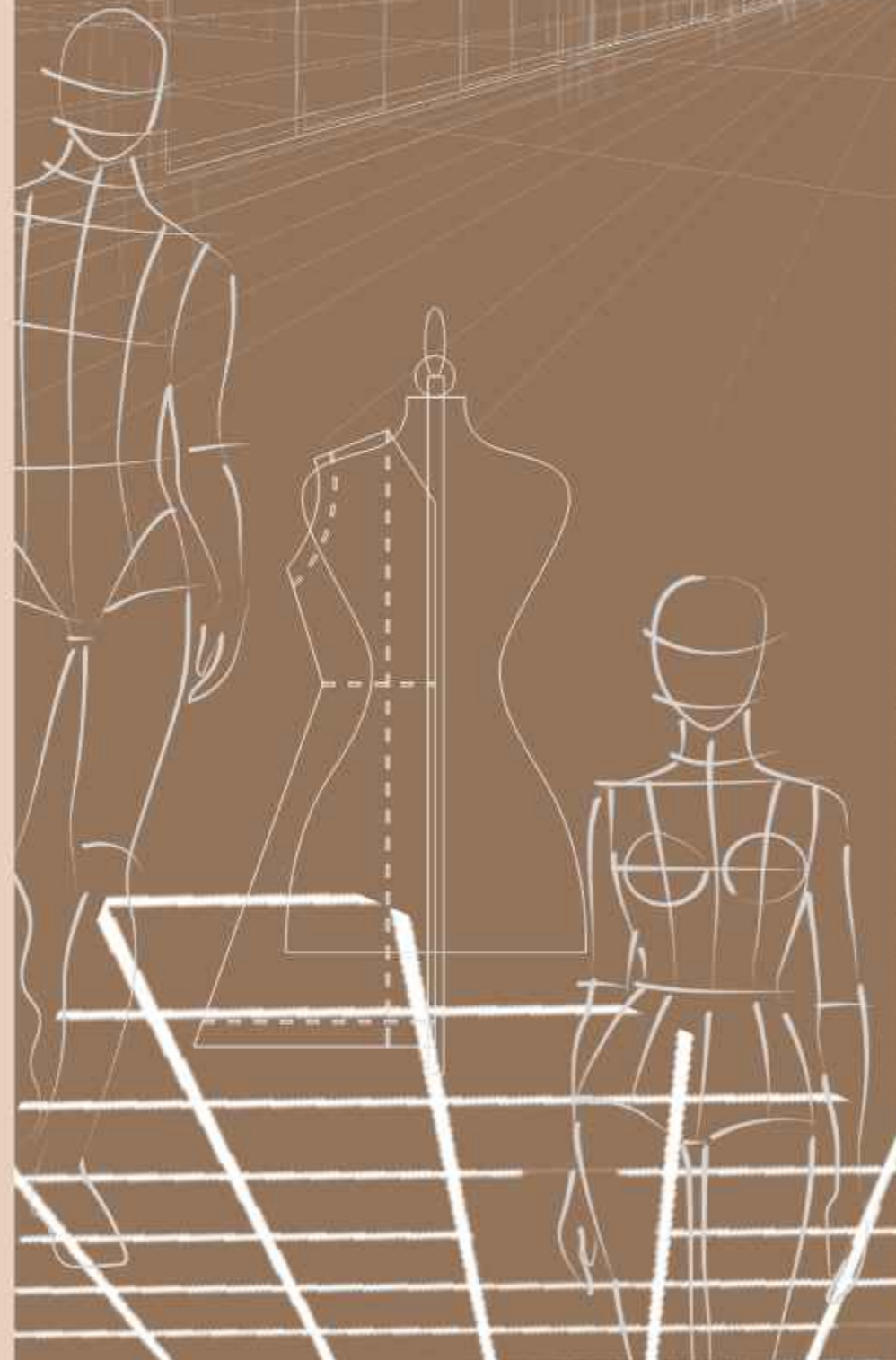

**D**ISEÑO ARQUITECTÓNICO DEL MÓDULO PARA LA CREACIÓN DE LA CARRERA DE DISEÑO Y GESTIÓN DE LA MODA, DEPENDIENTE DE LA FACULTAD DE CIENCIAS Y TECNOLOGÍAS DE LA UAJ.M.S. EN LA CIUDAD DE TARJÁ

**U.A.J.M.S.**  
**2022**

