

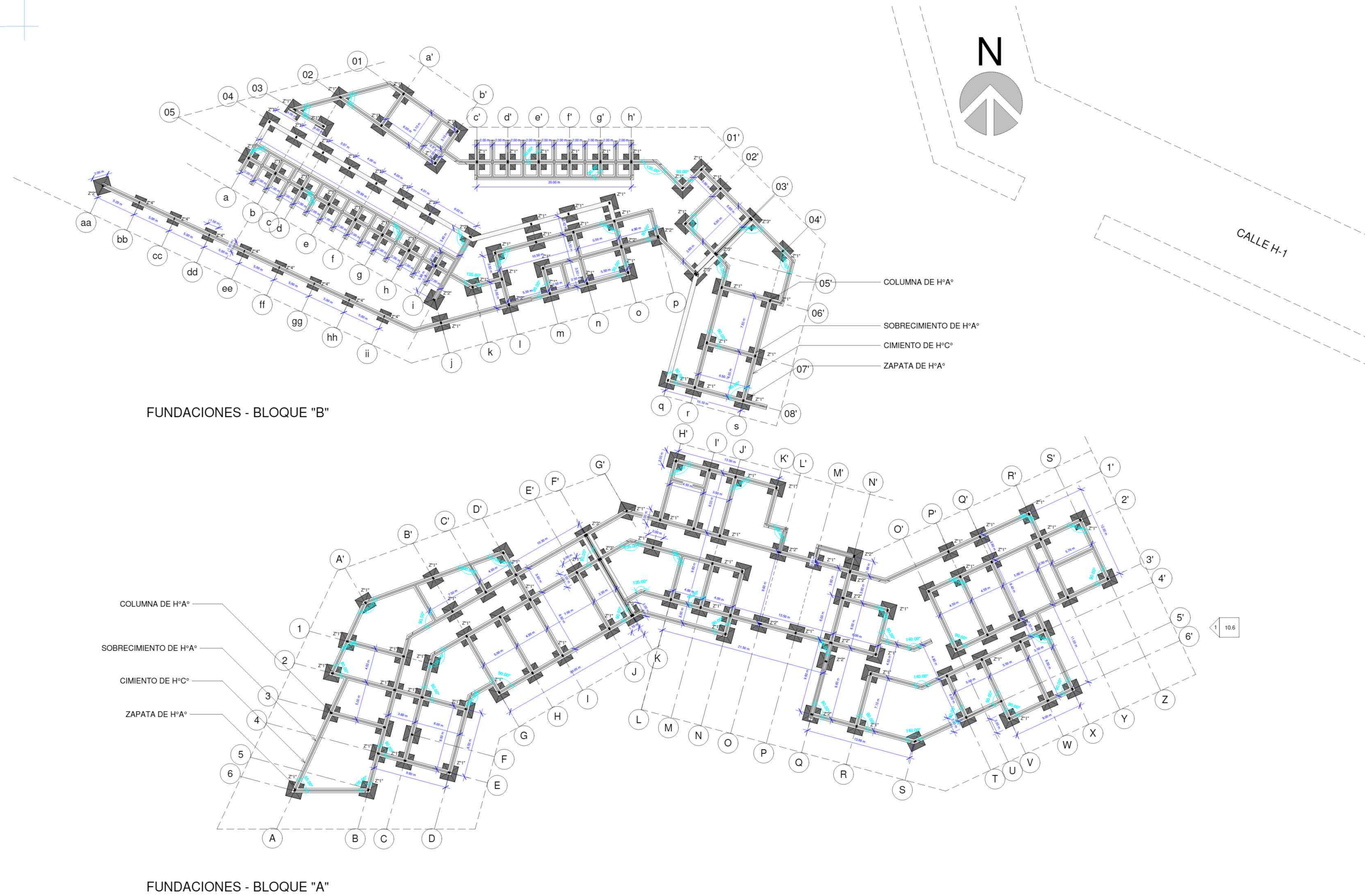

**...CENTRO INTEGRAL DE ATENCIÓN A GANES ABANDONADOS EN SITUACIÓN DE CALLE  
PARA LA CIUDAD DE TARIJA...**



1 CIMENTOS  
1 : 200

**PLANTA DE FUNDACIONES**

ESC. 1:200

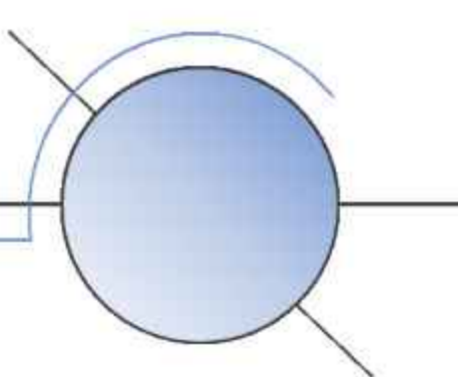

**U.A.J.M.S**  
**FACULTAD DE**  
**CIENCIAS**  
**Y TECNOLOGIA**

PROYECTO DE GRADO 2020

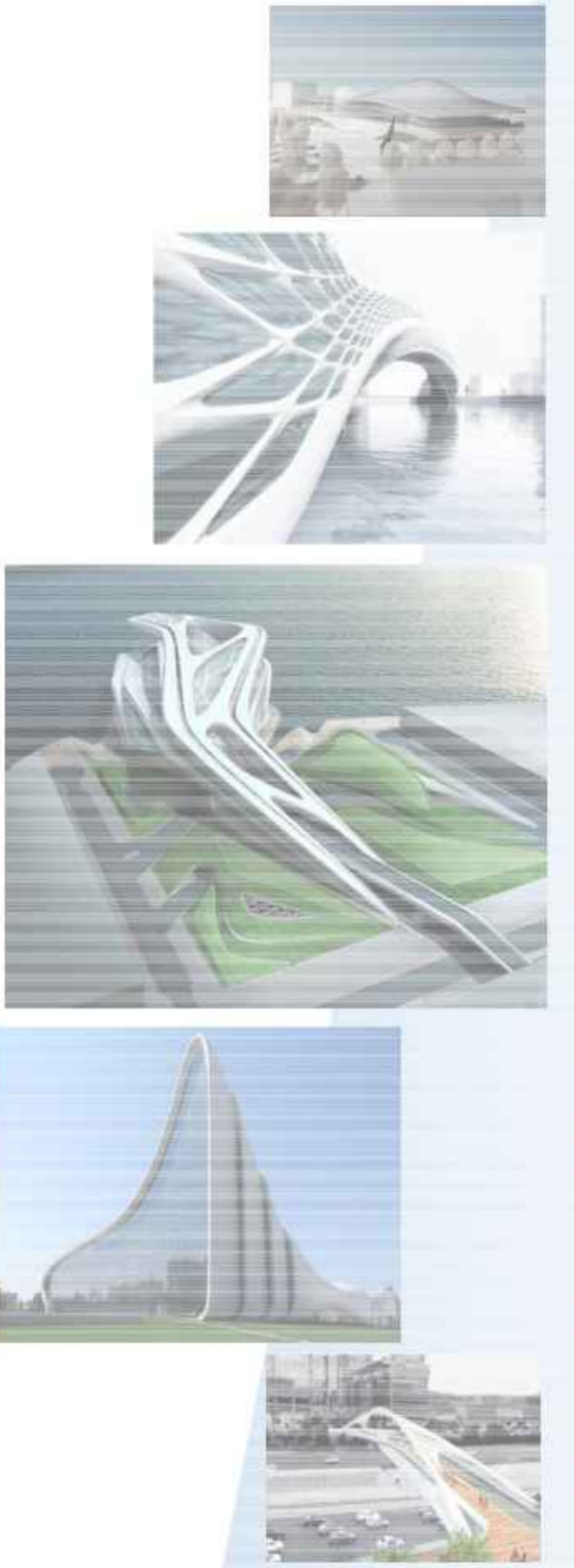

**GRUPO N° 4**

**- DOCENTE:**  
**ARQ. ÁLVARO**  
**BORDA.**  
**- ESTUDIANTE:**  
**LÓPEZ NAVARRO**  
**VIVIANA LIZ.**

LAMINA N°

**13/30**







**...CENTRO INTEGRAL DE ATENCIÓN A CANES ABANDONADOS EN SITUACIÓN DE CALLE  
PARA LA CIUDAD DE TARIJA...**

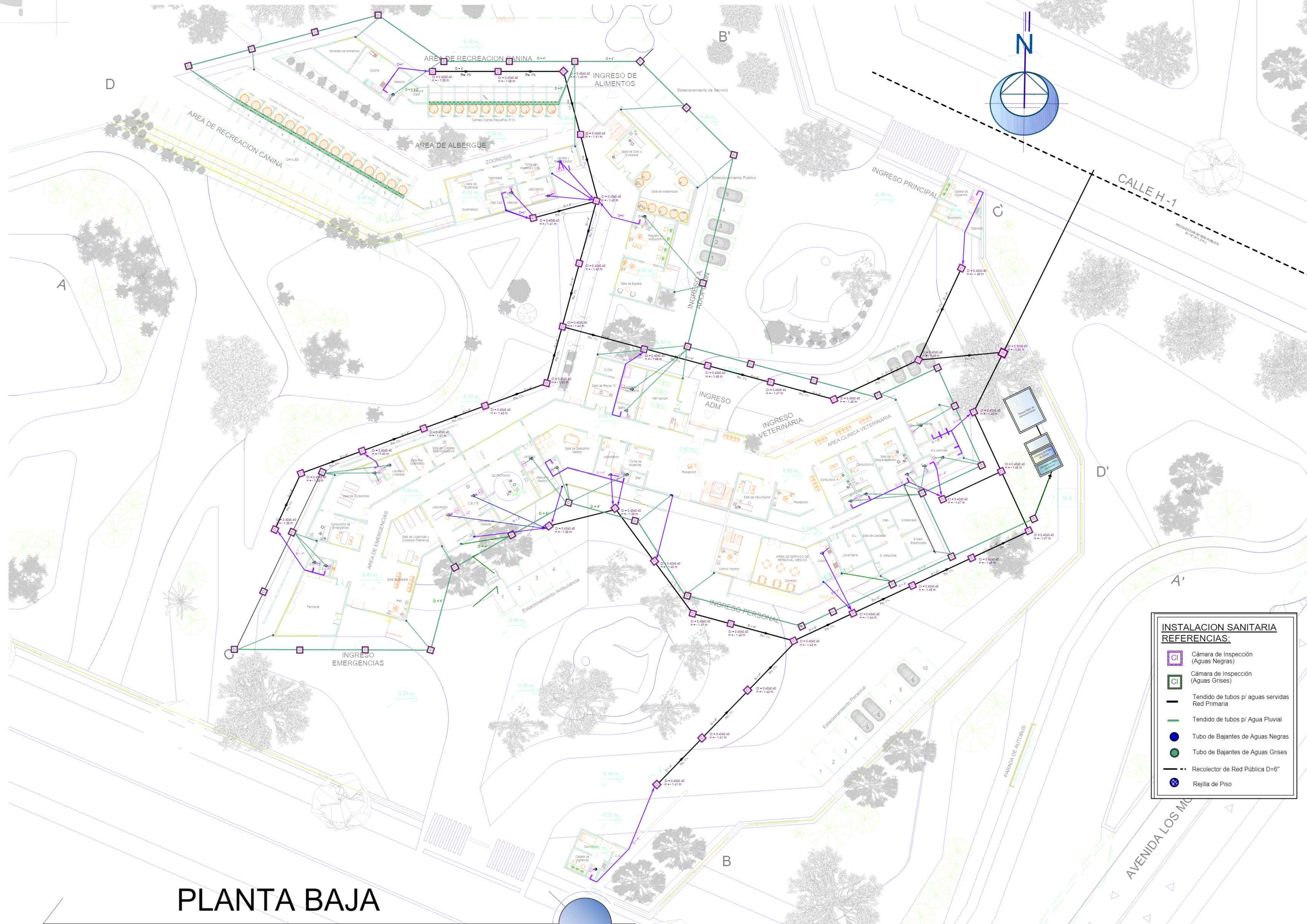

**PLANTA BAJA**

**INSTALACION SANITARIA**

Esc. 1:220



**U.A.J.M.S  
FACULTAD DE  
CIENCIAS  
Y TECNOLOGIA**

**PROYECTO DE GRADO 2020**

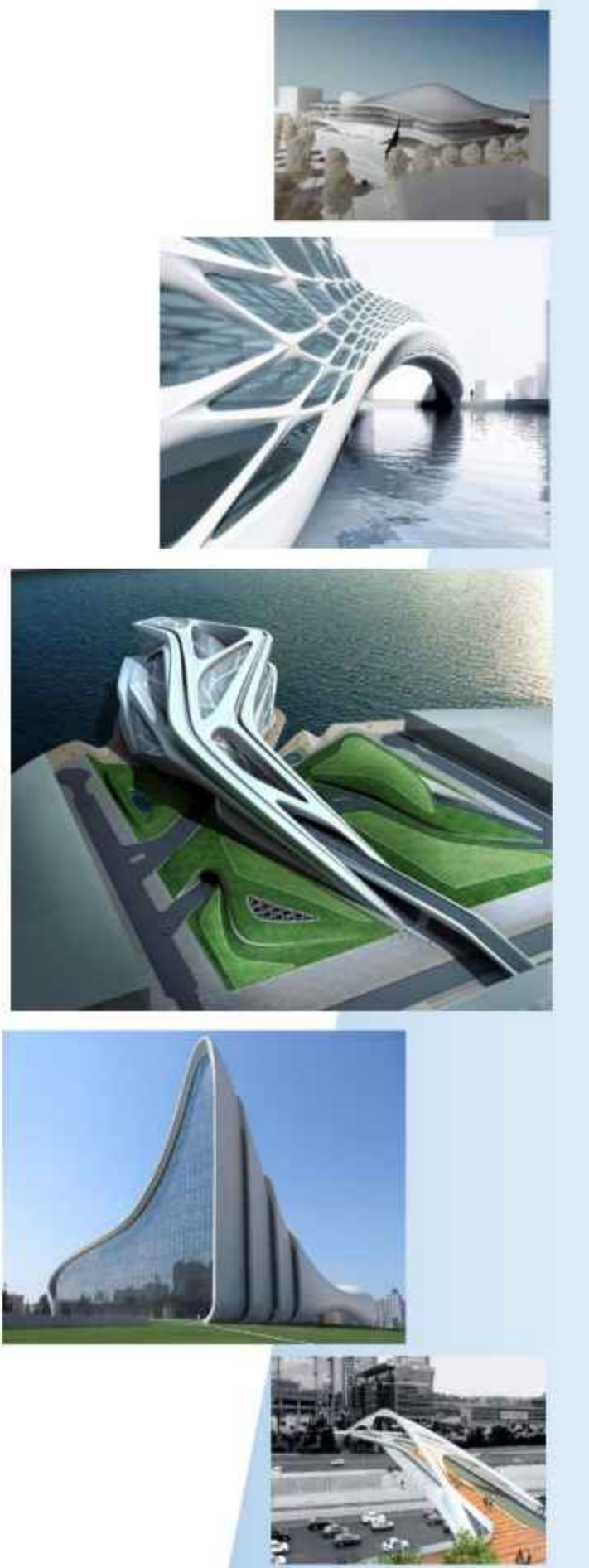

**GRUPO N° 4**

- **DOCENTE:**  
**ARQ. ÁLVARO BORDA.**
- **ESTUDIANTE:**  
**LÓPEZ NAVARRO VIVIANA LIZ.**

LAMINA N°

**14/30**







**...CENTRO INTEGRAL DE ATENCIÓN A CANES ABANDONADOS EN SITUACIÓN DE CALLE  
PARA LA CIUDAD DE TARIJA...**

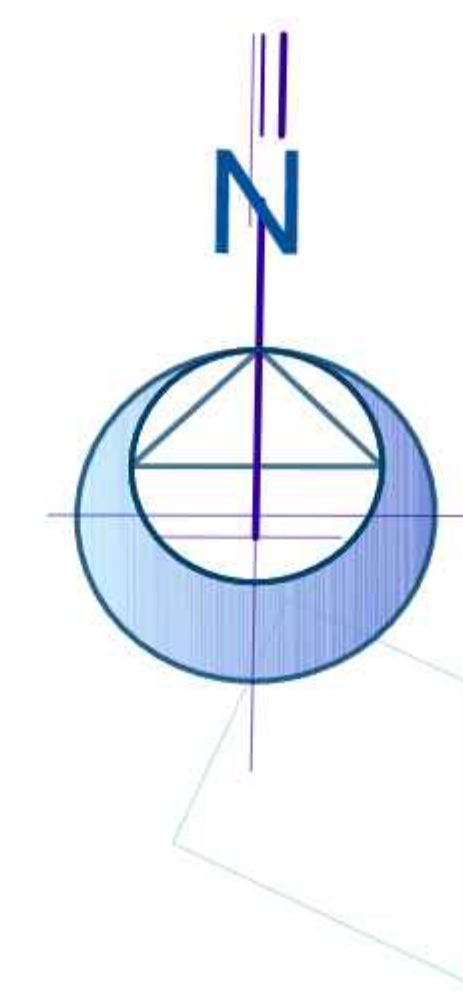
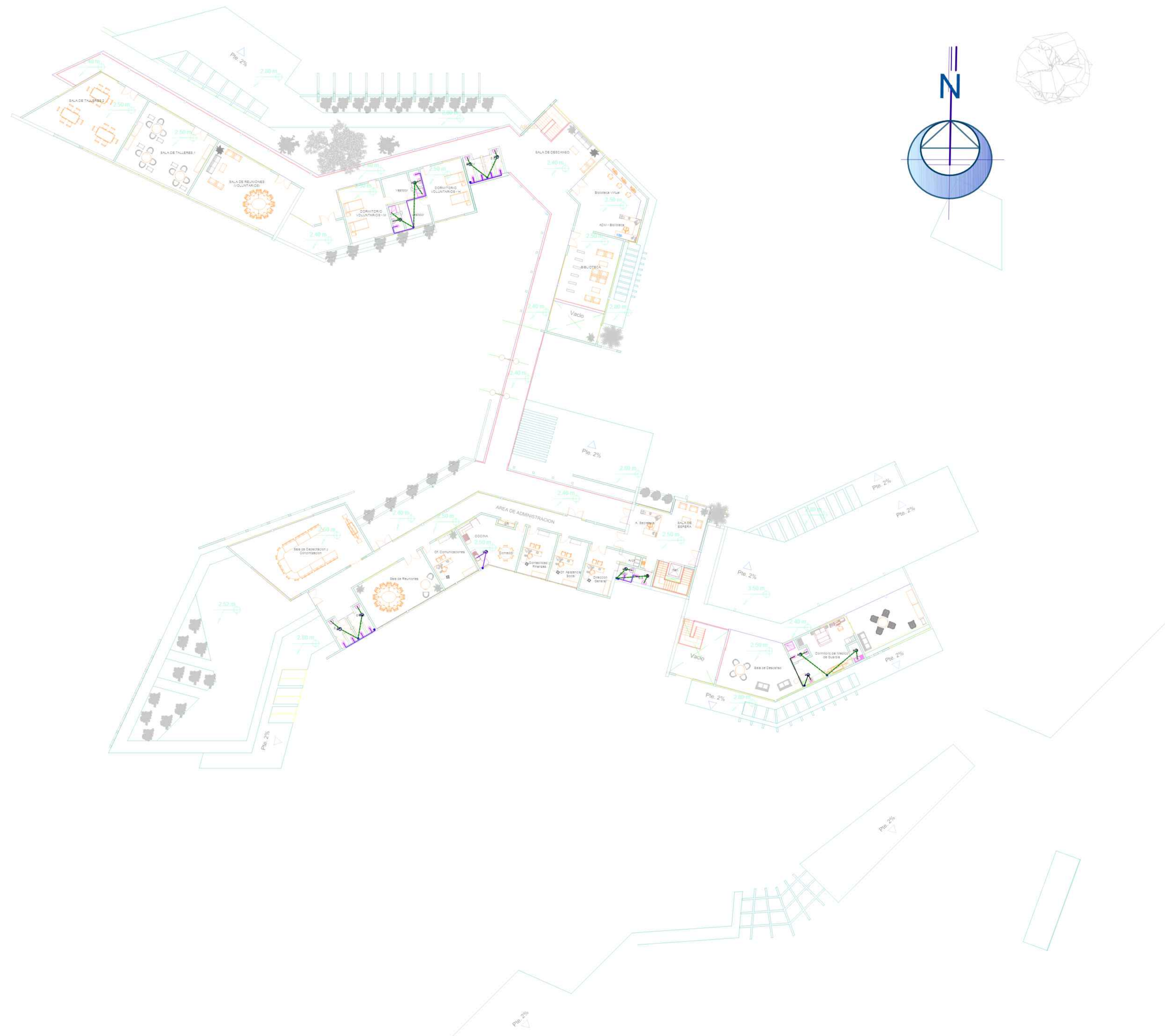

**INSTALACION SANITARIA**  
**REFERENCIAS:**

	Cámara de Inspección (Aguas Negras)
	Cámara de Inspección (Aguas Grises)
	Tendido de tubos p/ aguas servidas Red Primaria
	Tendido de tubos p/ Agua Pluvial
	Tubo de Bajantes de Aguas Negras
	Tubo de Bajantes de Aguas Grises
	Recolector de Red Pública D=6"
	Rejilla de Piso

**PLANTA ALTA**

**INSTALACION SANITARIA**

Esc. 1:220

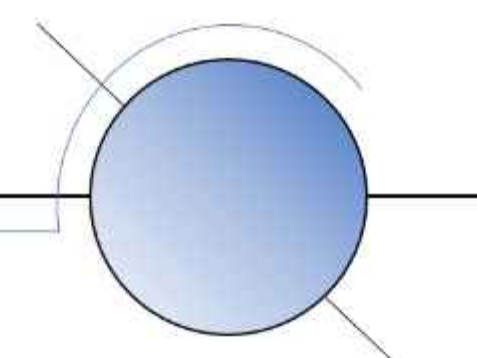

**U.A.J.M.S**  
**FACULTAD DE CIENCIAS Y TECNOLOGIA**

**PROYECTO DE GRADO 2020**

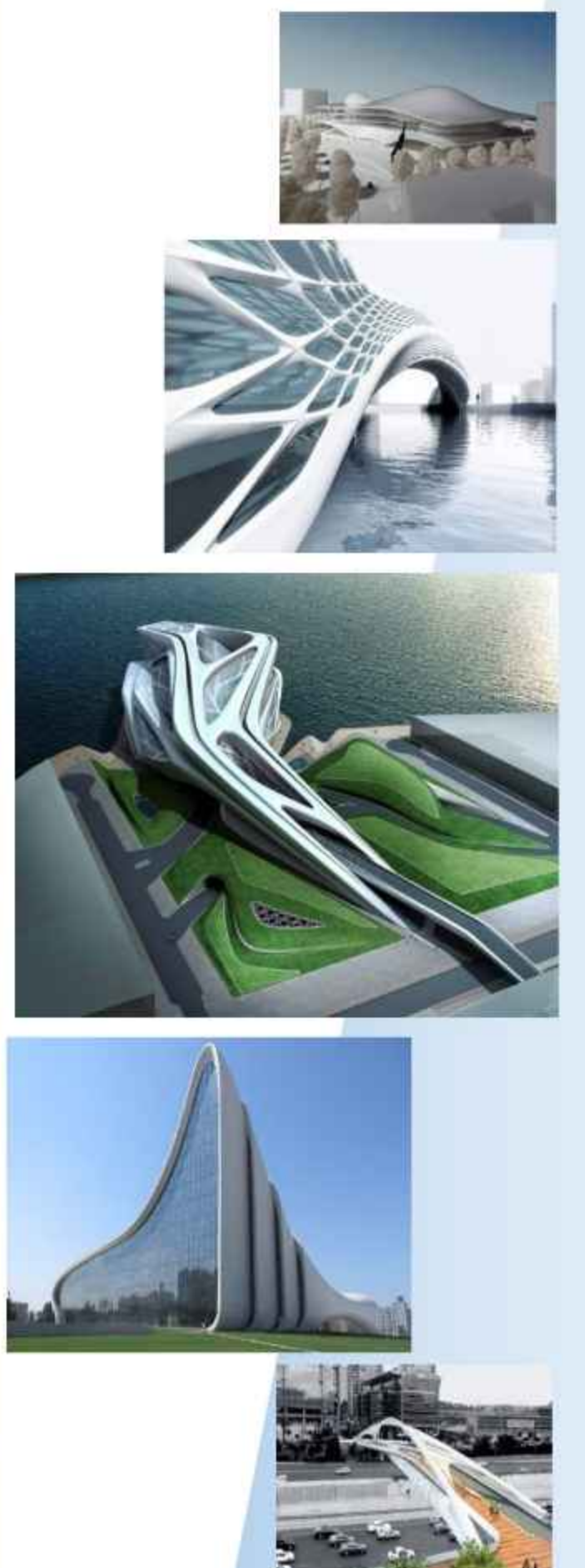

**GRUPO N° 4**

- **DOCENTE:**  
**ARQ. ÁLVARO BORDA.**
- **ESTUDIANTE:**  
**LÓPEZ NAVARRO VIVIANA LIZ.**

LAMINA N°

**14.1/30**







**...CENTRO INTEGRAL DE ATENCIÓN A CANES ABANDONADOS EN SITUACIÓN DE CALLE PARA LA CIUDAD DE TARIJA...**



**U.A.J.M.S**  
**FACULTAD DE CIENCIAS Y TECNOLOGIA**

**PROYECTO DE GRADO 2020**



**GRUPO Nº 4**

- **DOCENTE:**  
**ARQ. ÁLVARO BORDA.**
- **ESTUDIANTE:**  
**LÓPEZ NAVARRO VIVIANA LIZ.**

LAMINA Nº

**15/30**



	LUMINARIAS
	CONEXIÓN DE INTER A LABORATORIOS
	TOMA CORRIENTES
	FUSIBLES-EMERG.
	PLANTAS-EMERG. (SALA)
	PUNTO DE LUZ
	PUNTO DE LUZ (APLICABLE)
	PUNTO DE LUZ DOBLE (FLUORESCENTE) 40 W
	PUNTO DE LUZ DOBLE (FLUORESCENTE) 40 W
	PUNTO DE LUZ DOBLE (FLUORESCENTE) 40 W
	PUNTO DE LUZ DOBLE (FLUORESCENTE) 40 W
	PUNTO DE LUZ (SALA AMB. COCINA)
	TOMA CORRIENTE
	INTERFUSIBLES SIMPLE, DOBLE, TRIPLE
	COMBUSTIBLES SIMPLE
	CAJA DE FUSIBLES
	CAJA LABORATORIOS
	CAJA TOMA CORRIENTES
	MEDICIÓN
	BATERÍA DE ACUMULACIÓN DE ENERGÍA (SALA)

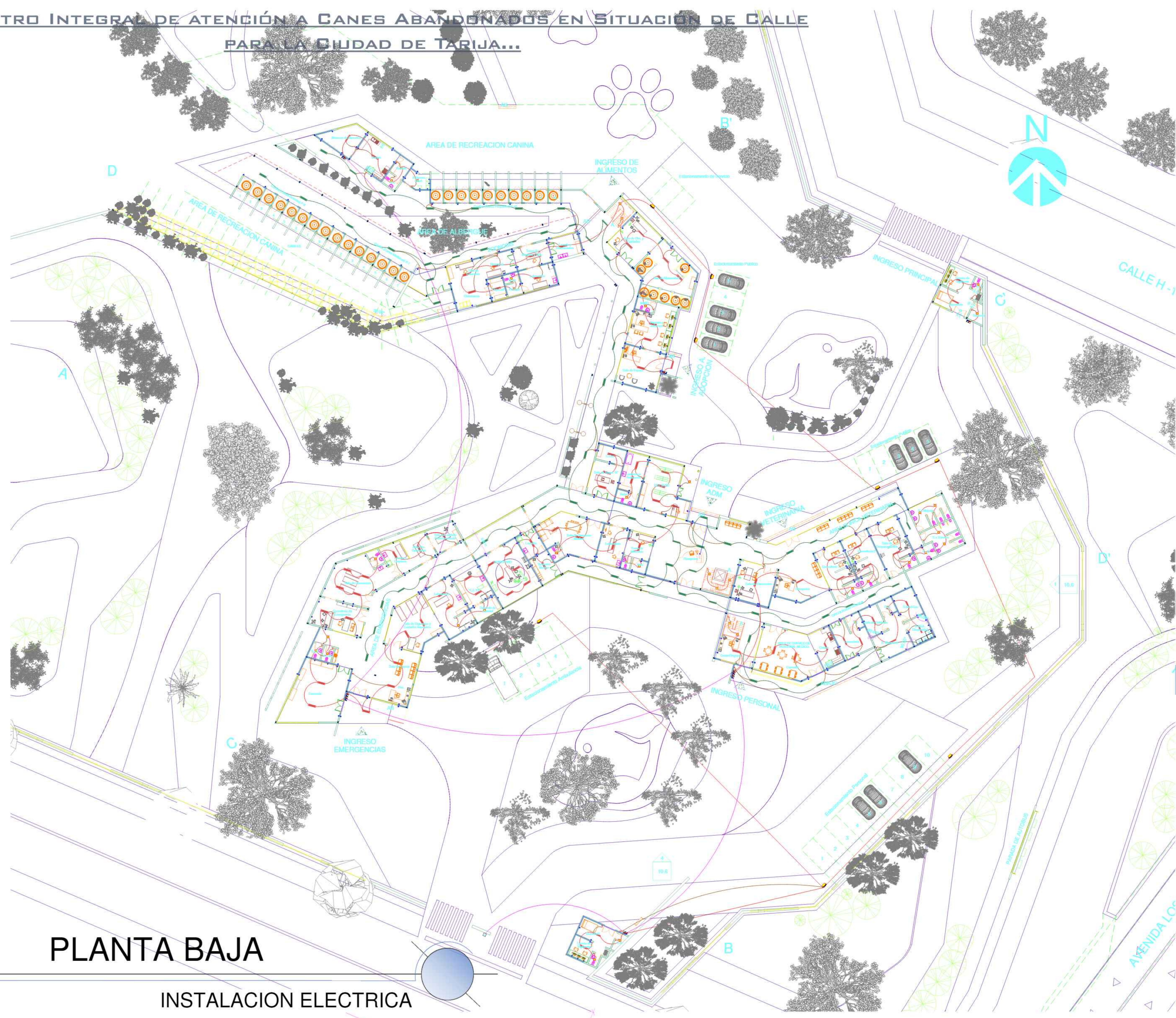

**PLANTA BAJA**

**INSTALACION ELECTRICA**

ESC. 1:220



AREA DE FUTURO CEMENTADO

AREA DE HERBIDO ECOLÓGICAS







**...CENTRO INTEGRAL DE ATENCIÓN A CANES ABANDONADOS EN SITUACIÓN DE CALLE PARA LA CIUDAD DE TARIJA...**

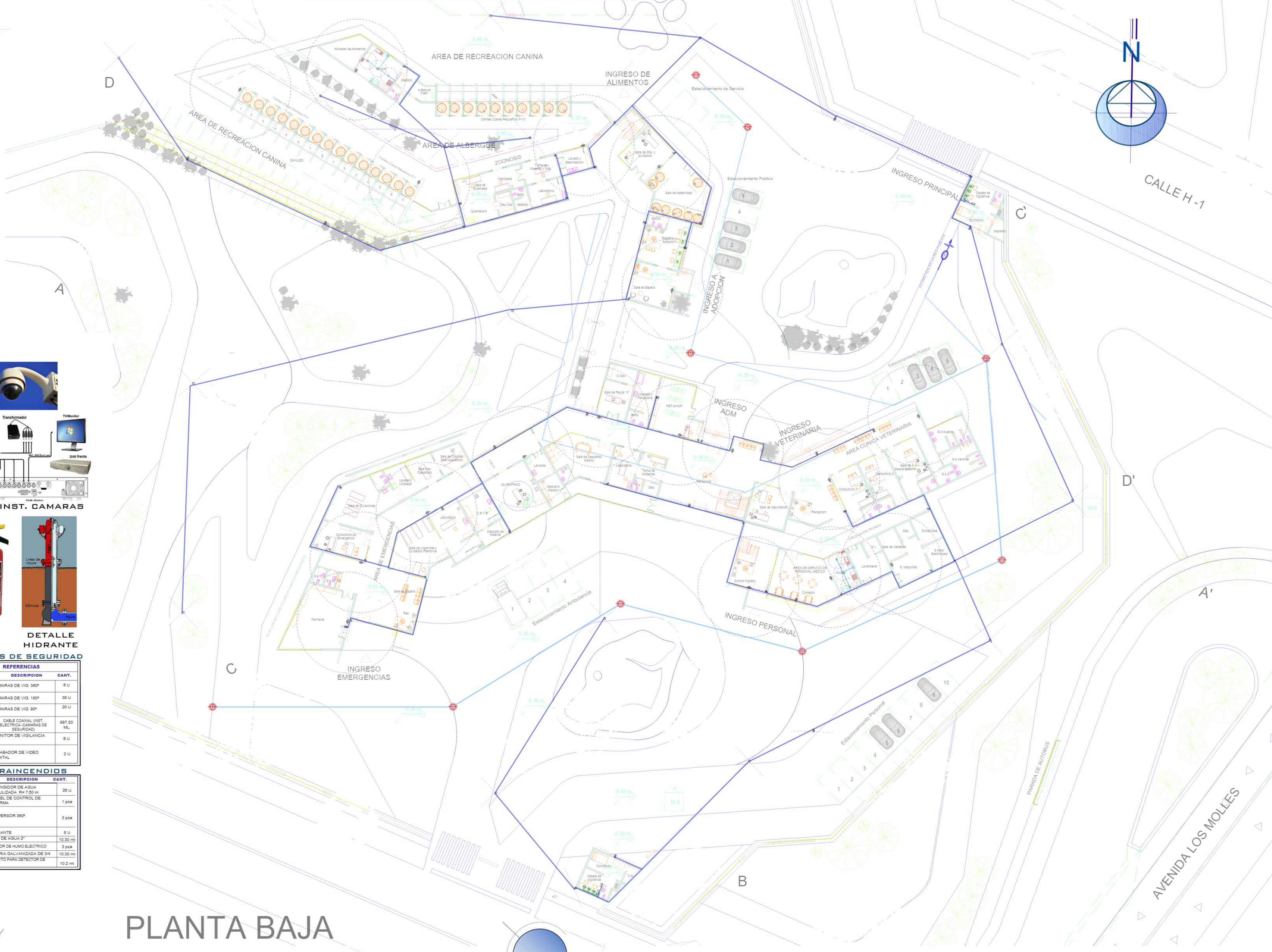

**U.A.J.M.S**  
FACULTAD DE CIENCIAS Y TECNOLOGIA

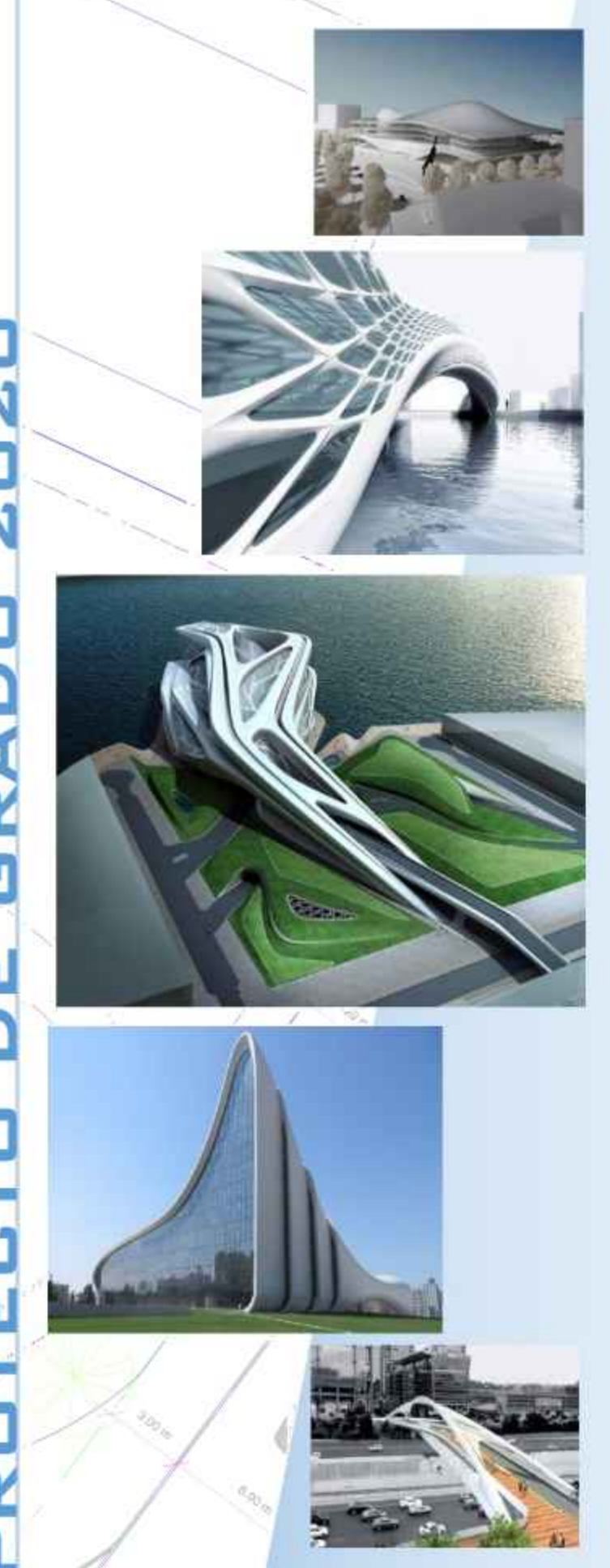

PROYECTO DE GRADO 2020

**GRUPO N° 4**

- **DOCENTE:** ARQ. ÁLVARO BORDA.
- **ESTUDIANTE:** LÓPEZ NAVARRO VIVIANA LIZ.

LAMINA N°

**16/30**

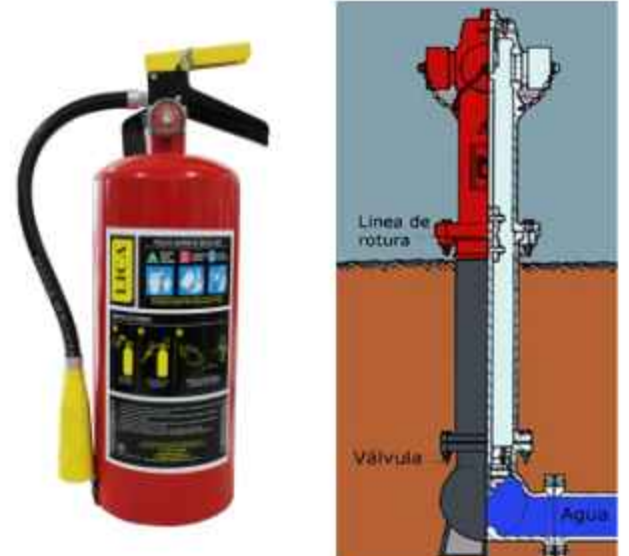

**CAMARAS DE SEGURIDAD**

SIMBOLO	DESCRIPCION	CANT.
	CAMARAS DE VIG. 360°	5 U
	CAMARAS DE VIG. 180°	38 U
	CAMARAS DE VIG. 90°	20 U
	CABLE COAXIAL INST. ELECTRICA -CAMARAS DE SEGURIDAD	897,20 ML
	MONITOR DE VIGILANCIA	5 U
	GRABADOR DE VIDEO DIGITAL	2 U

**CONTRA INCENDIOS**

SIMBOLO	DESCRIPCION	CANT.
	EXTINGUIDOR DE AGUA NEBULIZADA - R# 7,50 ml	20 U
	PANEL DE CONTROL DE ALARMA	1 pza
	ASPERSOR 300°	3 pza
	HIDRANTE	2 U
	"TUB" DE AGUA 2"	10,30 ml
	SENSOR DE HUMO ELECTRICO	3 pza
	TUBERIA GALVANIZADA DE 3/4"	10,30 ml
	CABLE PARA DETECTOR DE HUMO	10,2 ml

**PLANTA BAJA**

Esc. 1:220

INSTALACION DE SEGURIDAD Y CONTRA INCENDIOS





**...CENTRO INTEGRAL DE ATENCIÓN A CANES ABANDONADOS EN SITUACIÓN DE CALLE  
PARA LA CIUDAD DE TARIJA...**

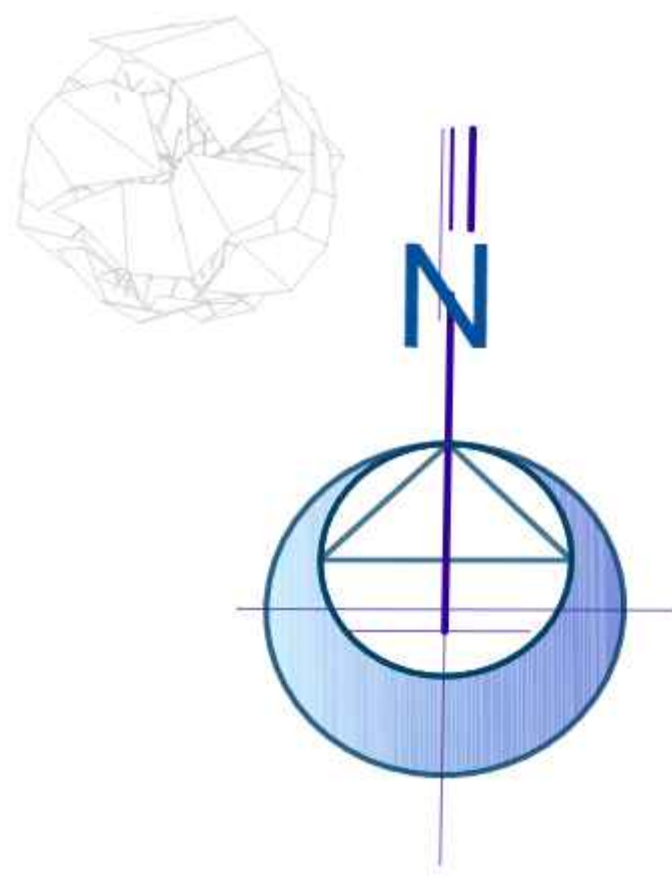
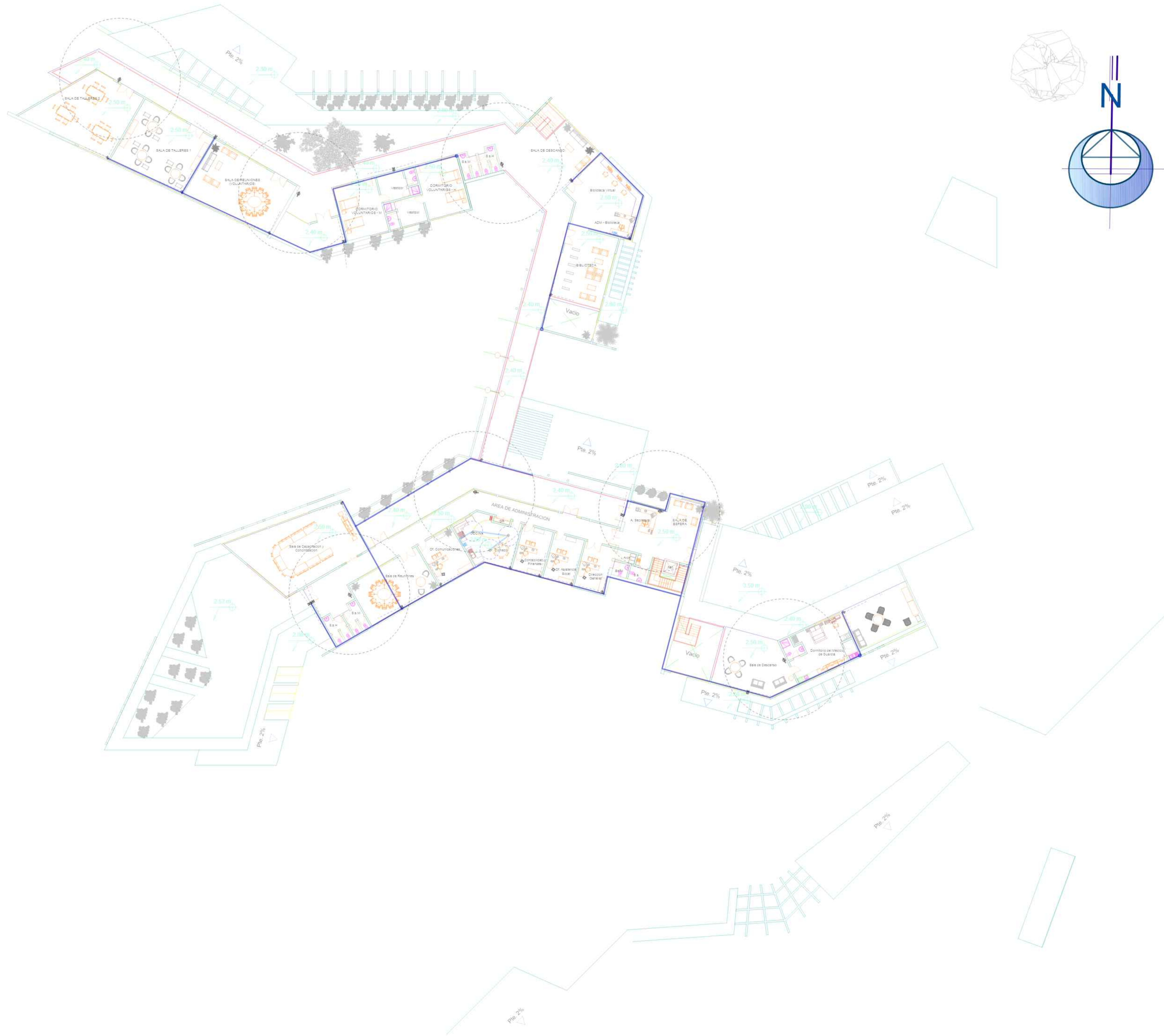

**CAMARAS DE SEGURIDAD**

REFERENCIAS		
SÍMBOLO	DESCRIPCIÓN	CANT.
	CAMARAS DE VISO 360°	5 U
	CAMARAS DE VISO 180°	38 U
	CAMARAS DE VISO 90°	20 U
	CABLE COAXIAL INST. ELECTRICA CAMARAS DE SEGURIDAD	897.20 ML
	MONITOR DE VIGILANCIA	5 U
	GRABADOR DE VIDEO DIGITAL	2 U

**CONTRA INCENDIOS**

SÍMBOLO	DESCRIPCIÓN	CANT.
	EXTINGUIDOR DE AGUA NEBLIZADA. R# 7.50 m	28 U
	PANEL DE CONTROL DE ALARMA	1 pza
	ASPIRSOR 360°	3 pza
	HIDRANTE	8 U
	TUBE DE AGUA 2"	10.30 m
	SENSOR DE HUMO ELECTRICO	3 pza
	TUBERIA GALVANIZADA DE 3/4"	10.30 m
	CIRCUITO PARA DETECTOR DE HUMO	10.2 m

**PLANTA ALTA**

Esc. 1:220

INSTALACION DE SEGURIDAD Y CONTRA INCENDIOS

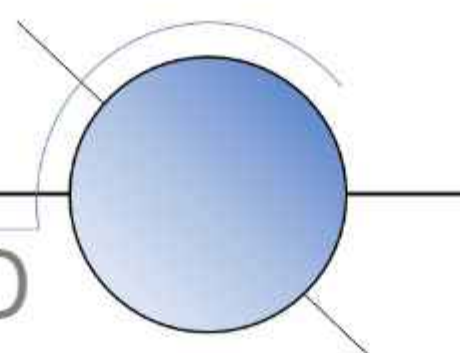

**U.A.J.M.S  
FACULTAD DE  
CIENCIAS  
Y TECNOLOGIA**

PROYECTO DE GRADO 2020

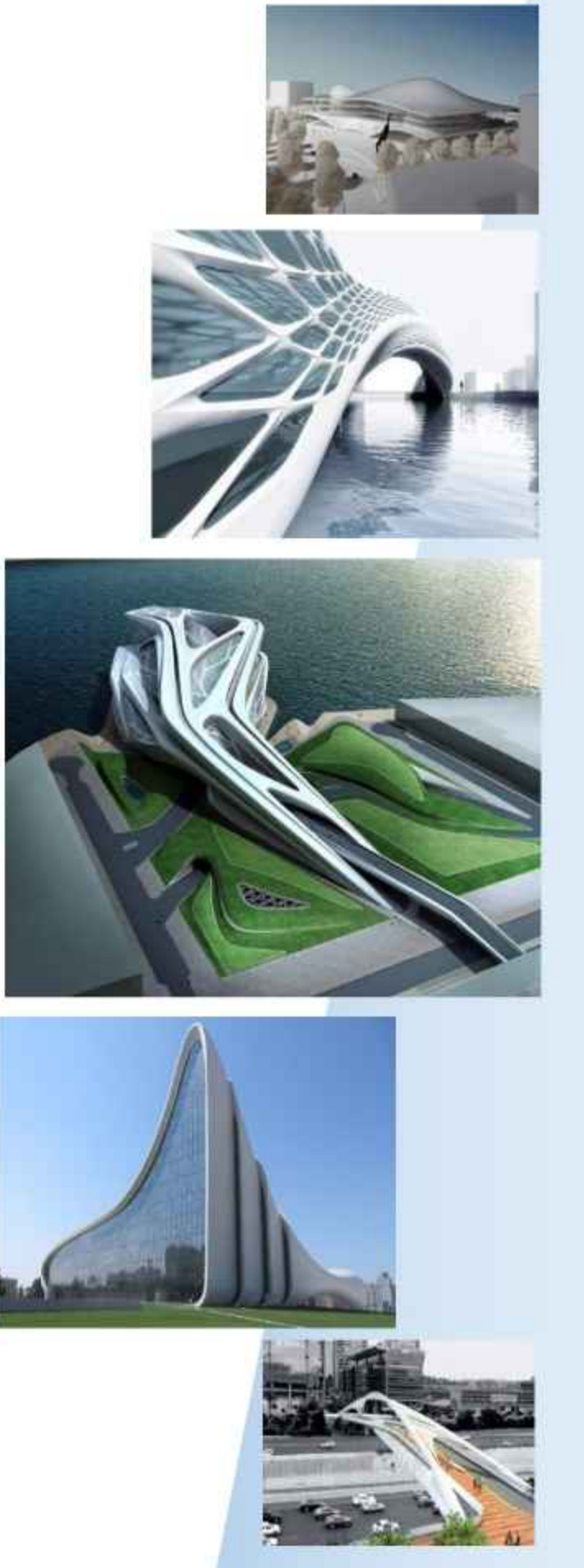

**GRUPO N° 4**

- **DOCENTE:**  
ARQ. ÁLVARO BORDA.
- **ESTUDIANTE:**  
LÓPEZ NAVARRO VIVIANA LIZ.

LAMINA N°



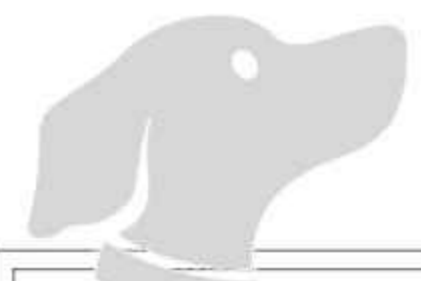

...CENTRO INTEGRAL DE ATENCIÓN A CANES ABANDONADOS EN SITUACIÓN DE CALLE  
PARA LA CIUDAD DE TARIJA...

**DETALLE DE ZAPATA**

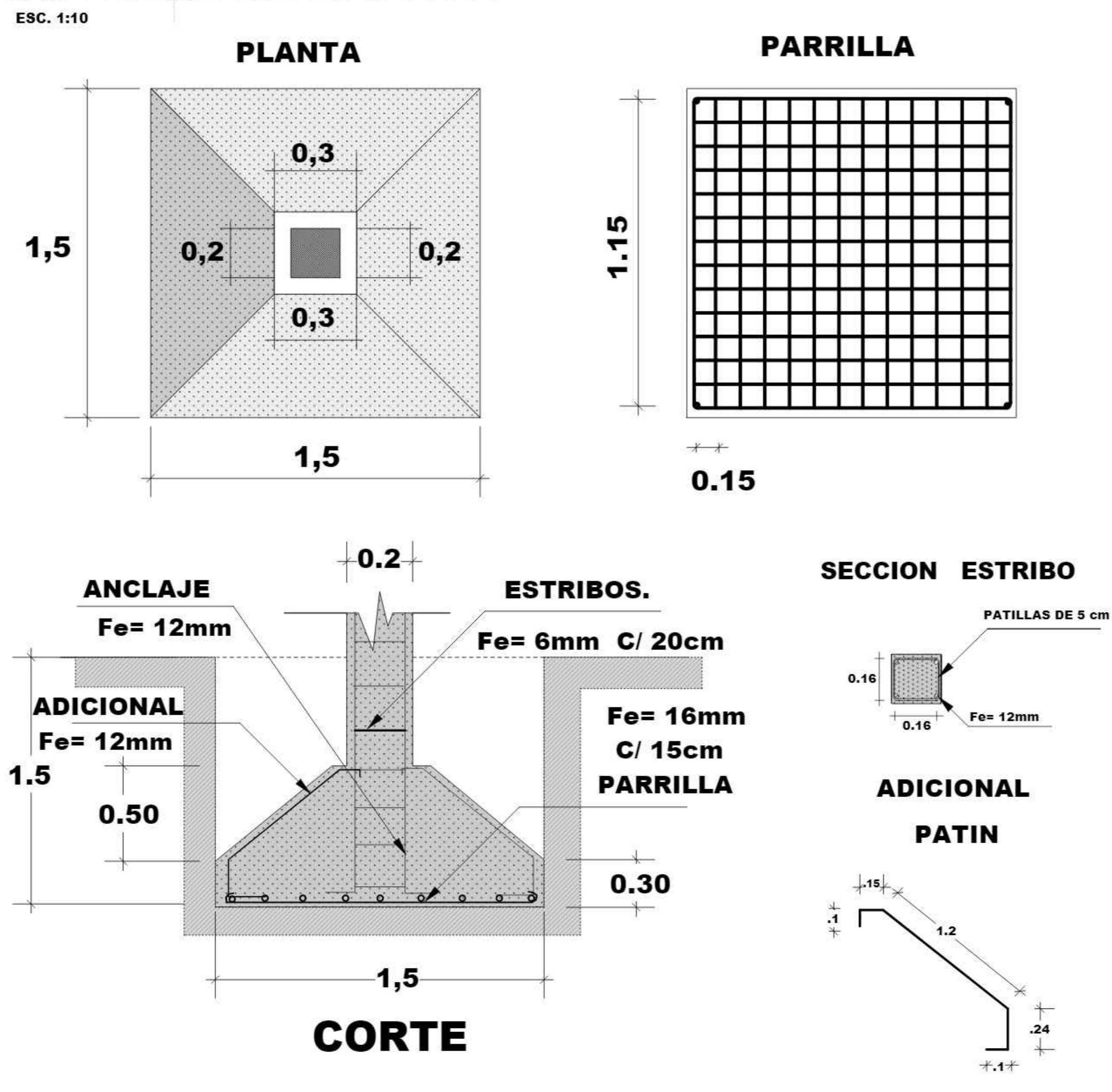

**DETALLE DE TECHO VERDE**

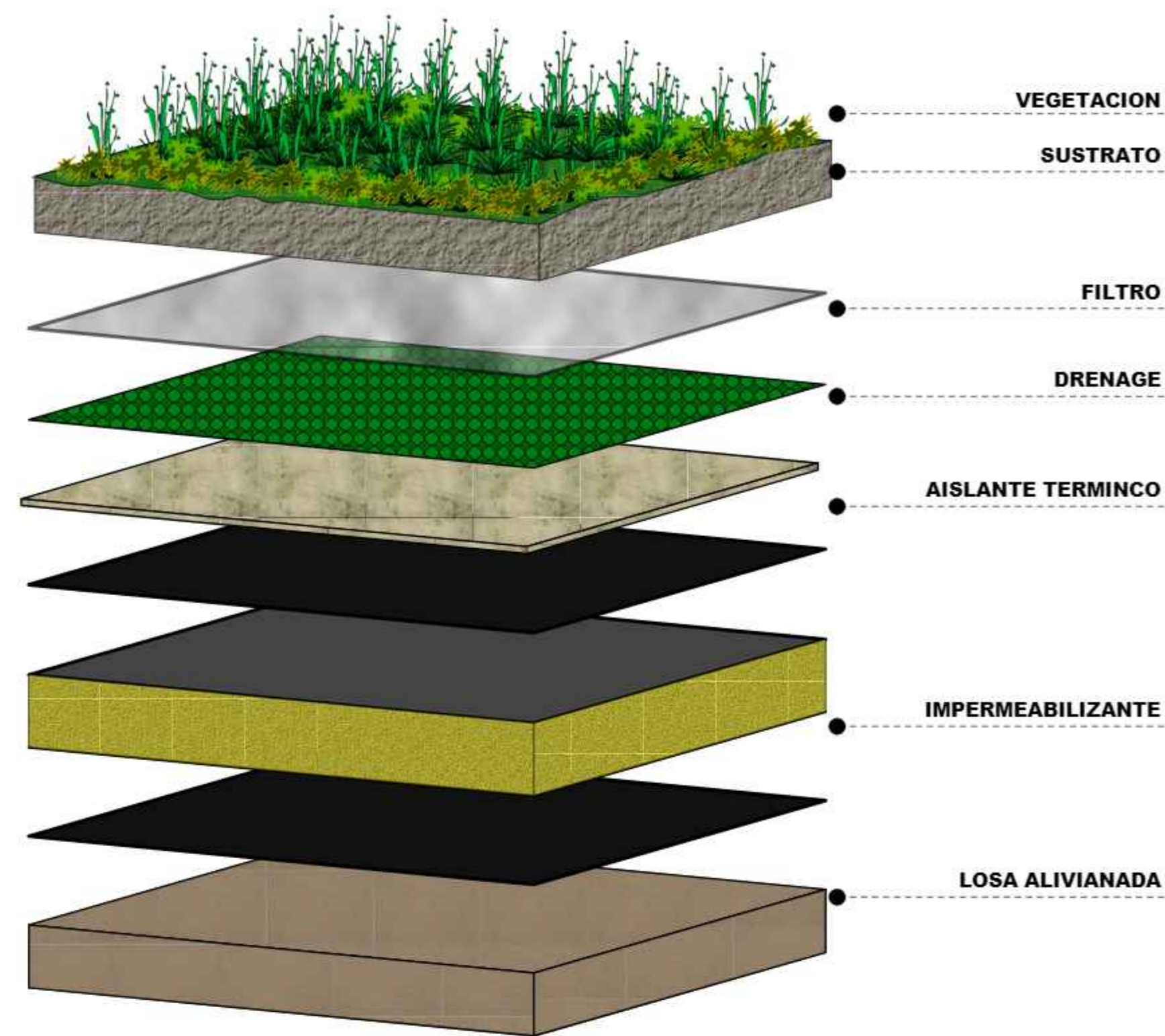

**DETALLE DE LOSA SIN VIGA**

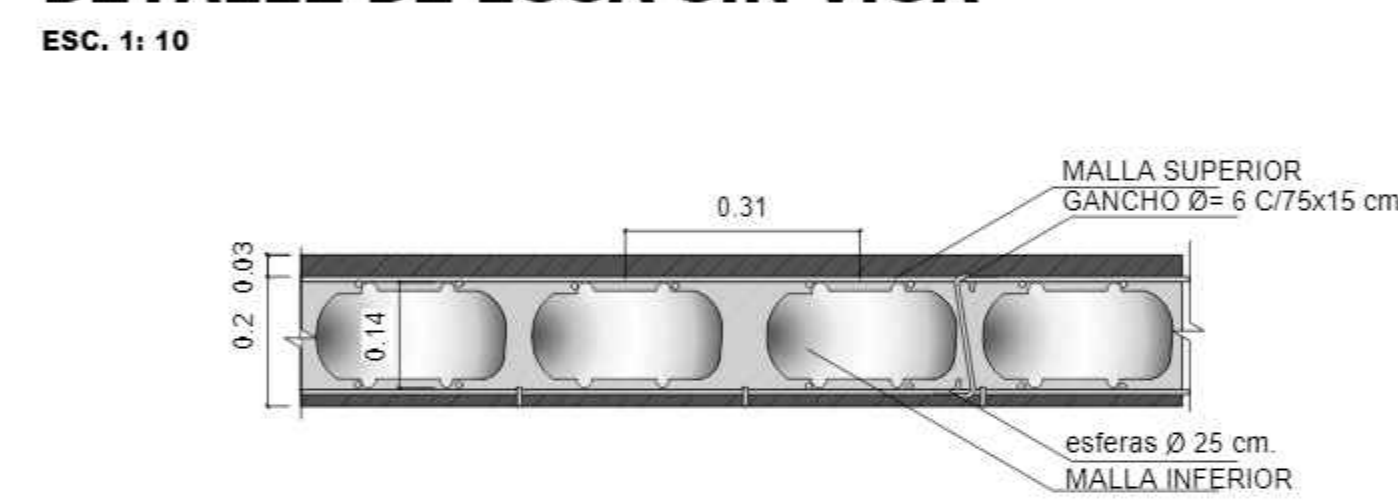

**DETALLE DE LOSA ALIVIANADA**

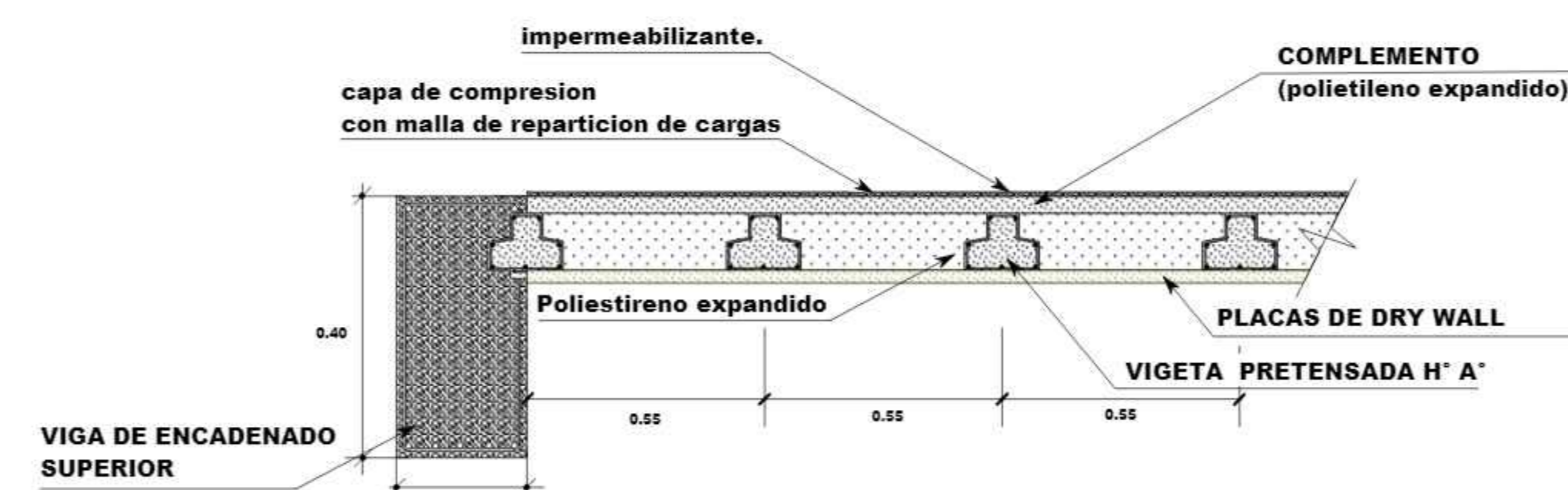

**GRADA**

Esc. 1:10

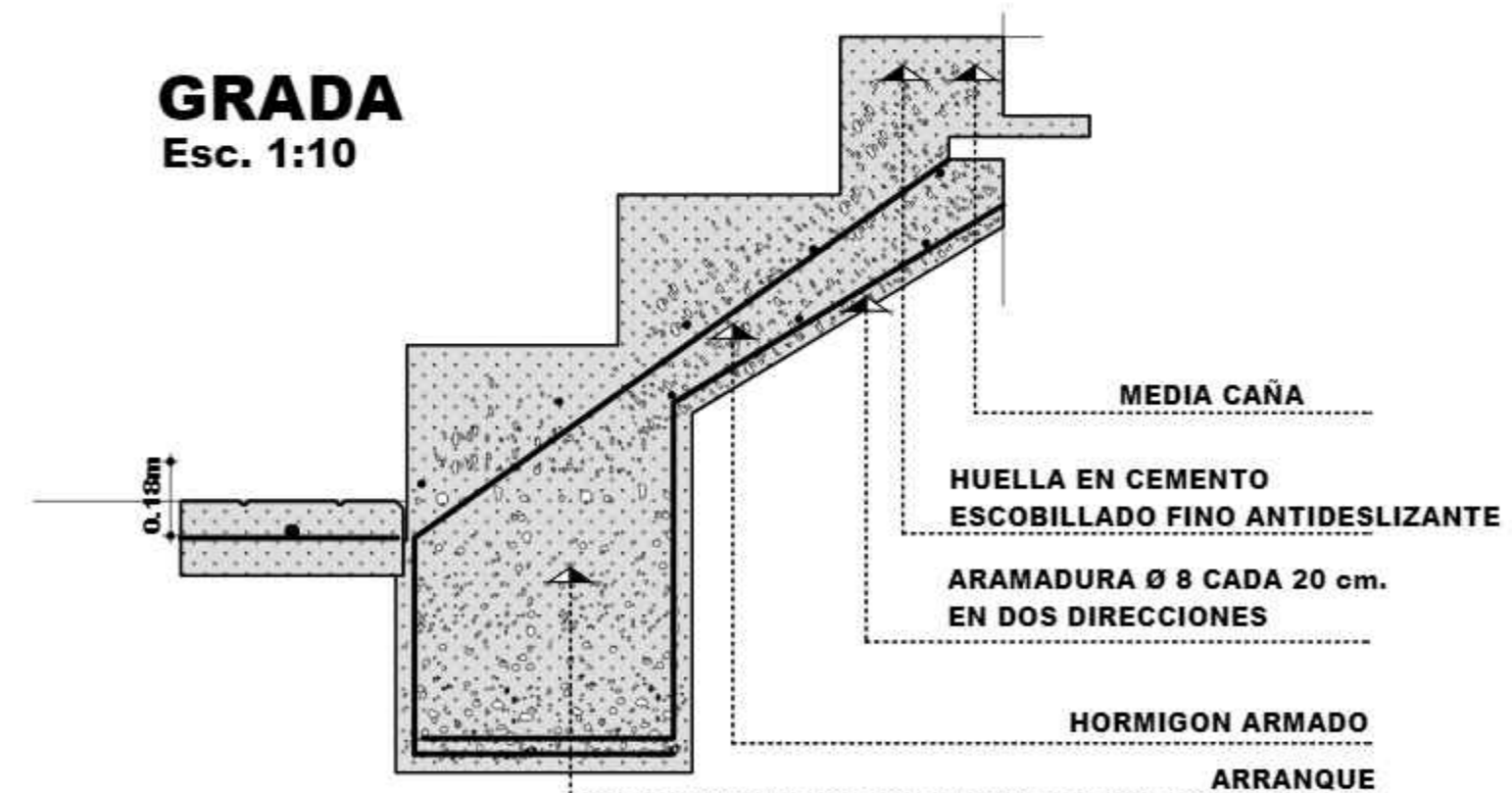

**DETALLE PISO EXTERIOR**

Esc. 1:10

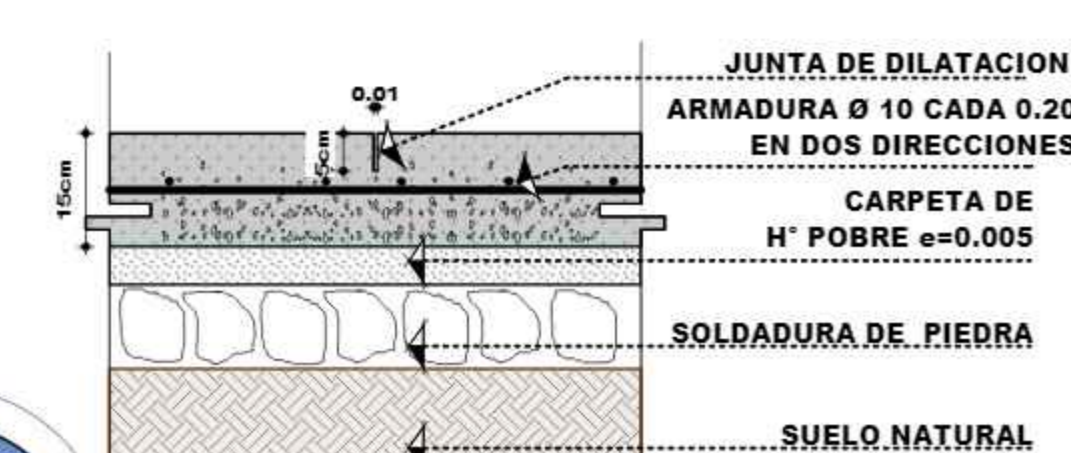

**DETALLE DE MURO CORTINA**

ESC 1:20

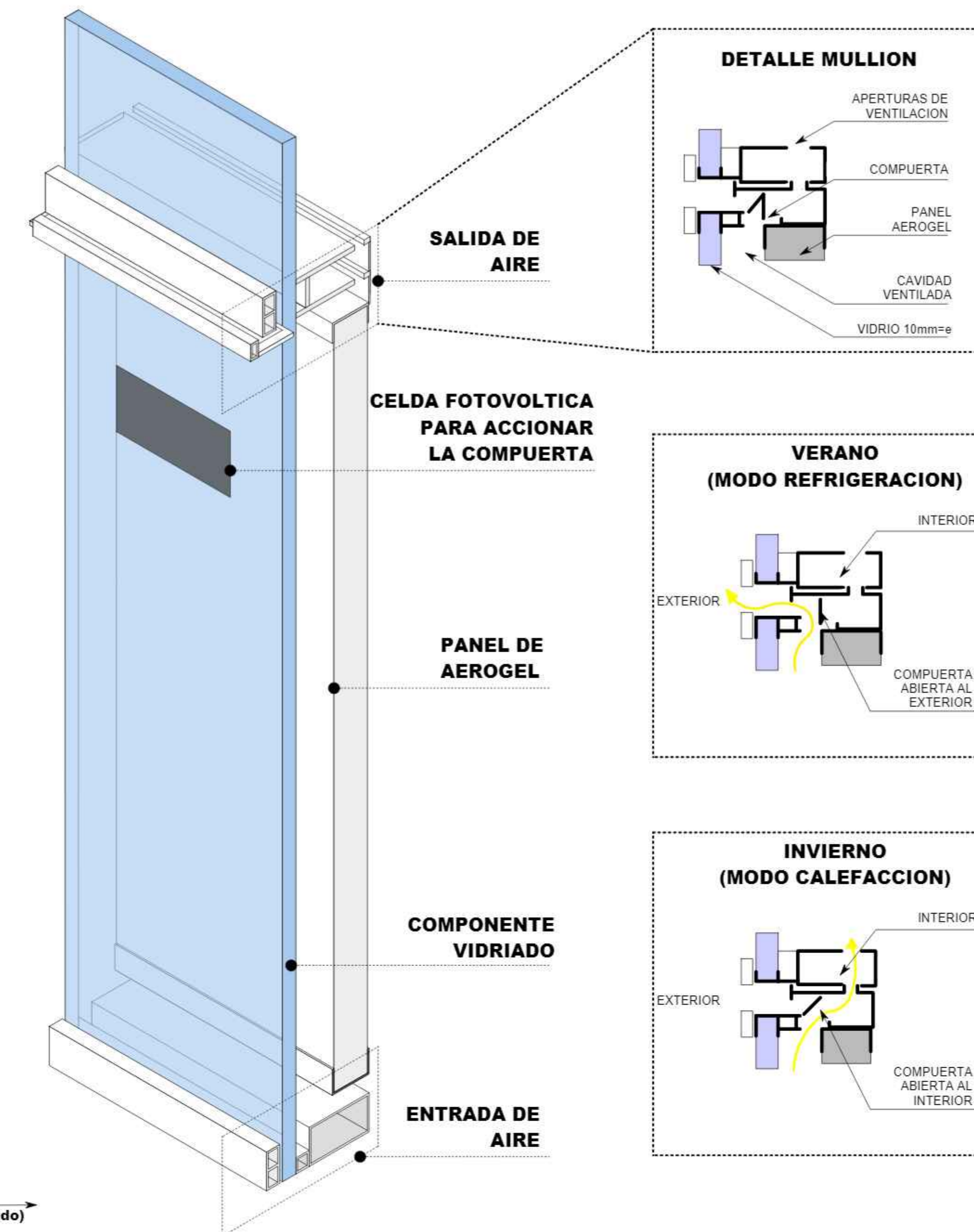

**ZAPATA COMBINADA DE DOS COLUMNAS**

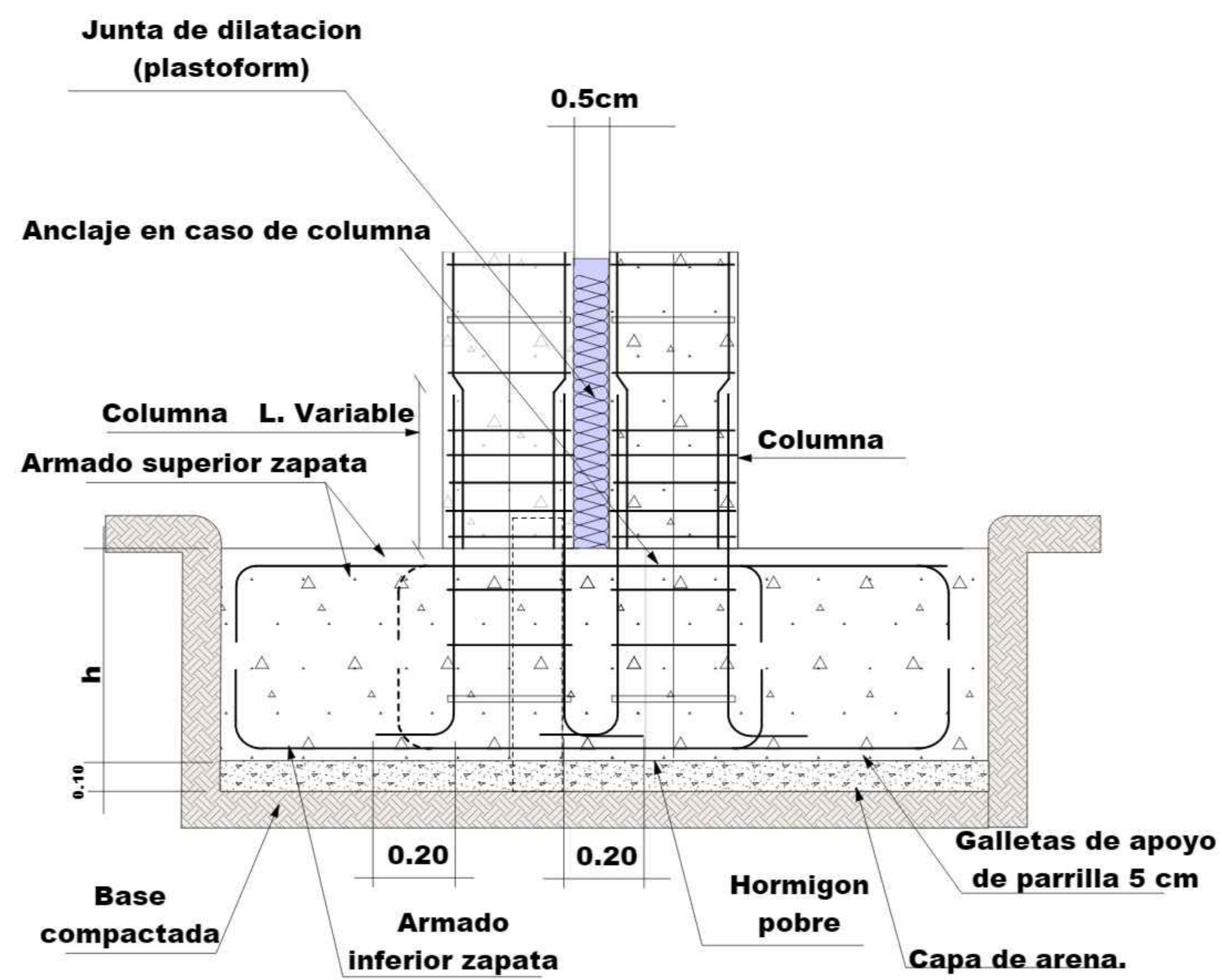

**CORAZA METALICA DE PROTECCION DE LA JUNTA DE DILATACION EN LA LOSA**

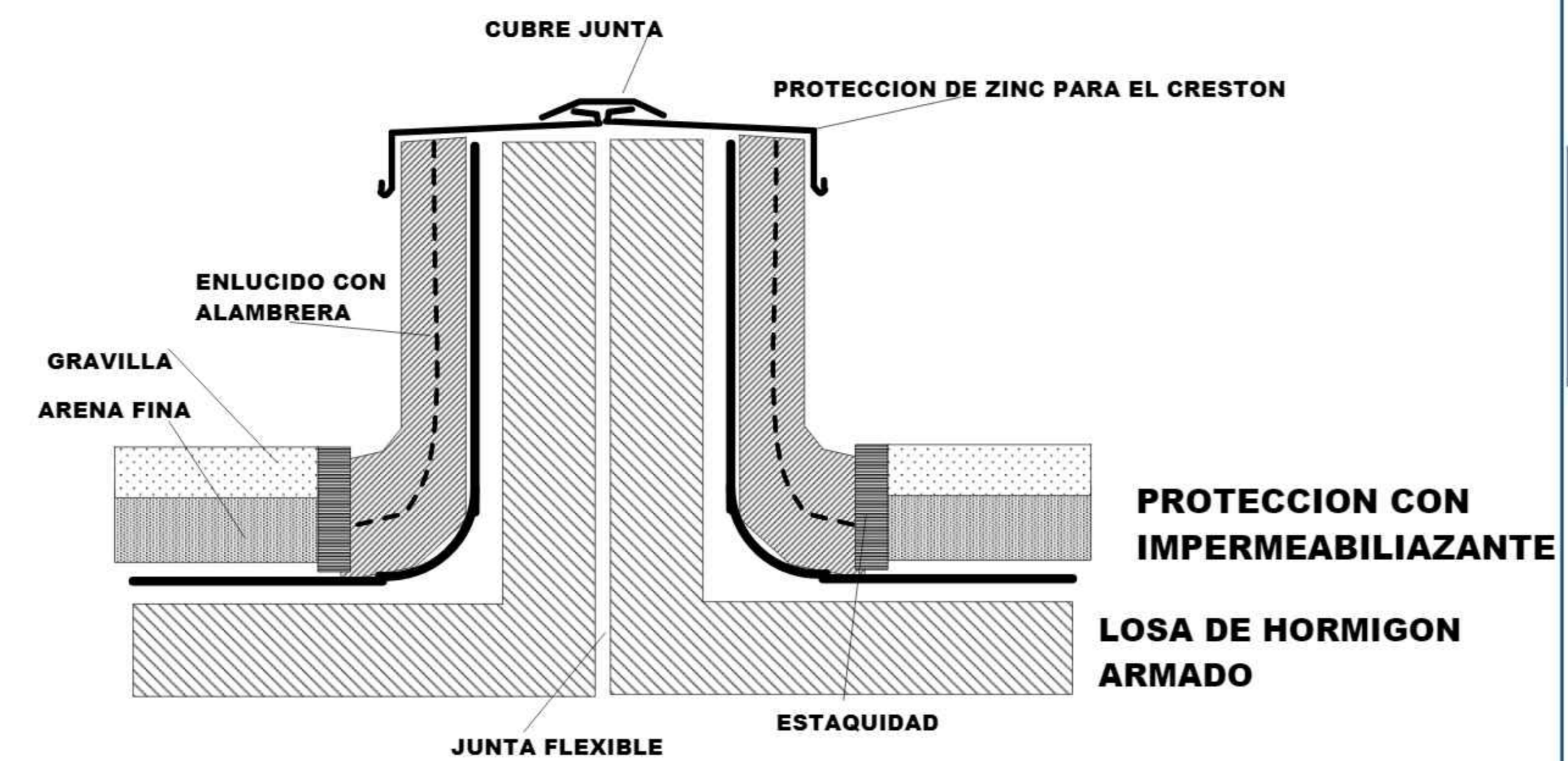

**DETALLES CONSTRUCTIVOS**

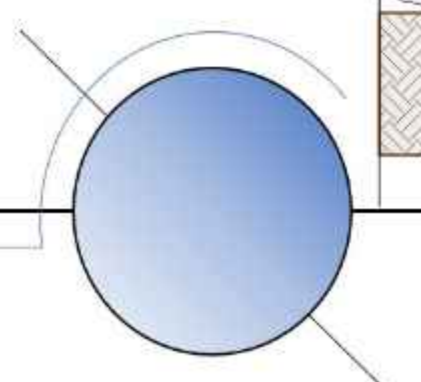

**U.A.J.M.S**  
FACULTAD DE CIENCIAS Y TECNOLOGIA

PROYECTO DE GRADO 2020

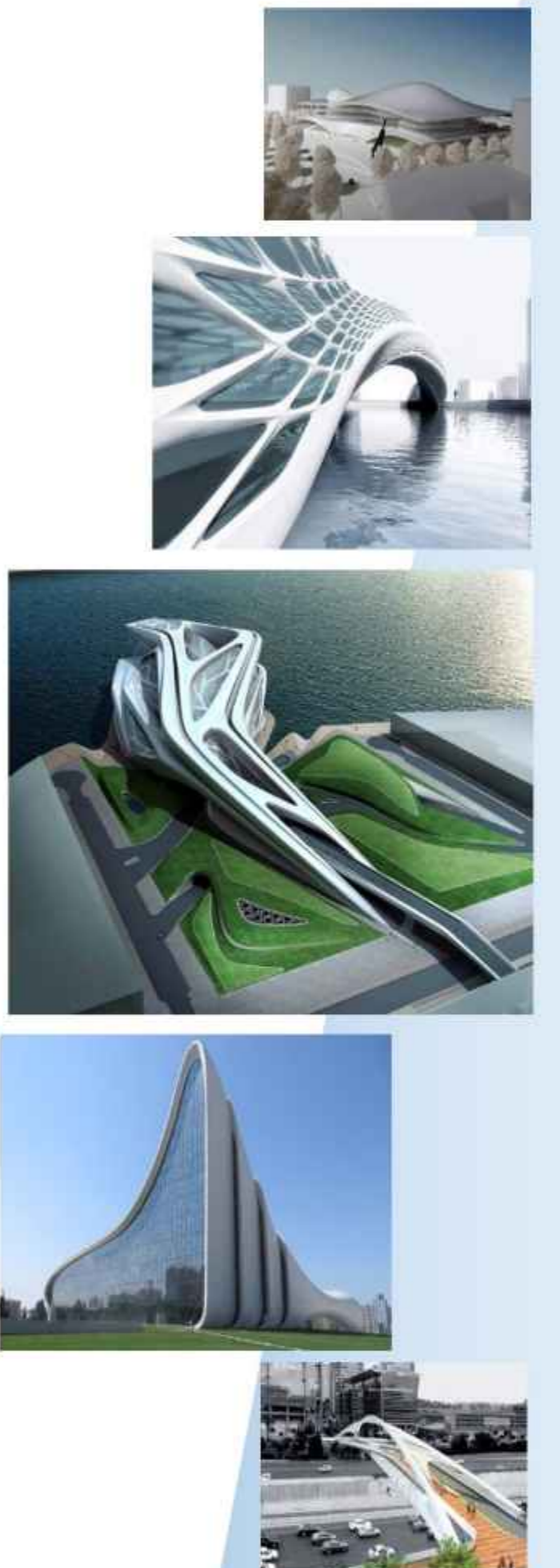

**GRUPO N° 4**

- **DOCENTE:**  
ARQ. ÁLVARO BORDA.  
- **ESTUDIANTE:**  
LÓPEZ NAVARRO VIVIANA LIZ.

LAMINA N°

17/30





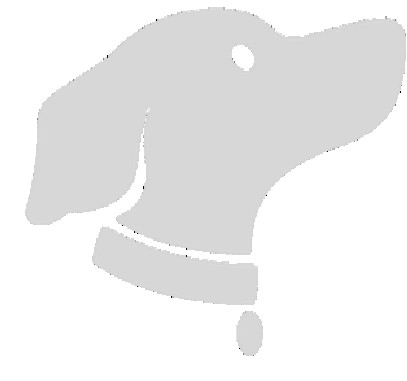

**...CENTRO INTEGRAL DE ATENCIÓN A CANES ABANDONADOS EN SITUACIÓN DE CALLE  
PARA LA CIUDAD DE TARIJA...**

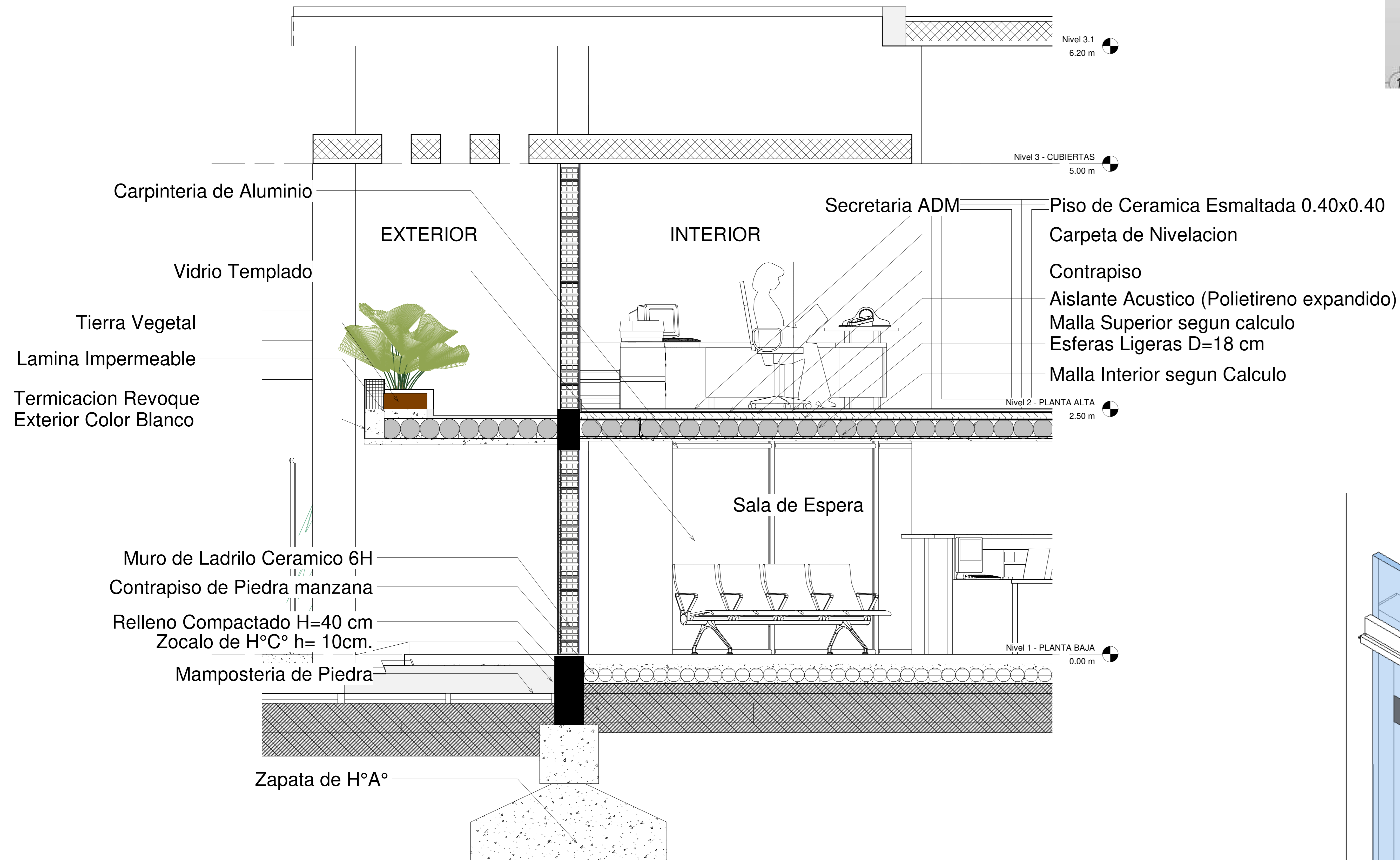

**CORTE DE BORDE**

ESC. 1:20

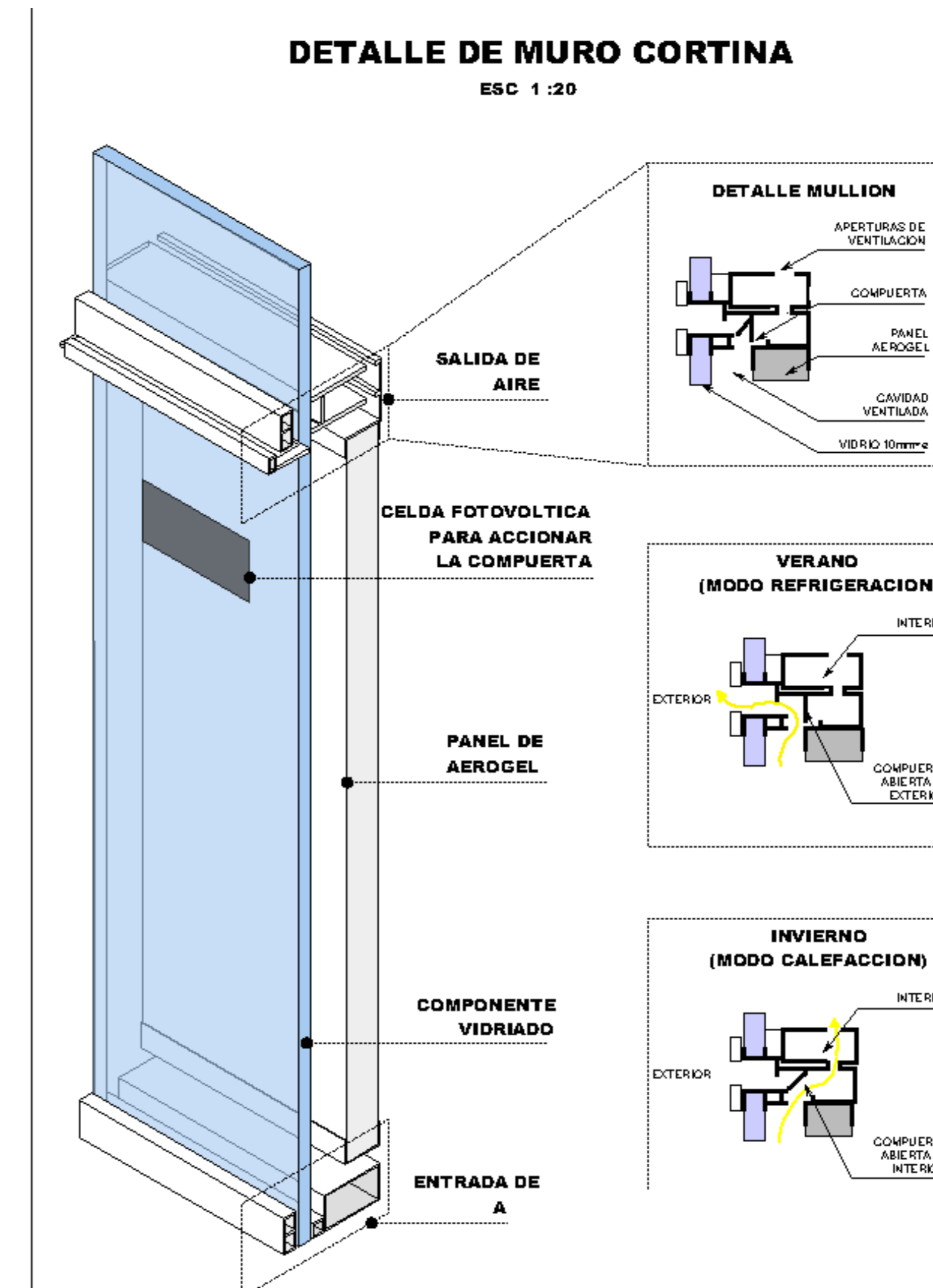
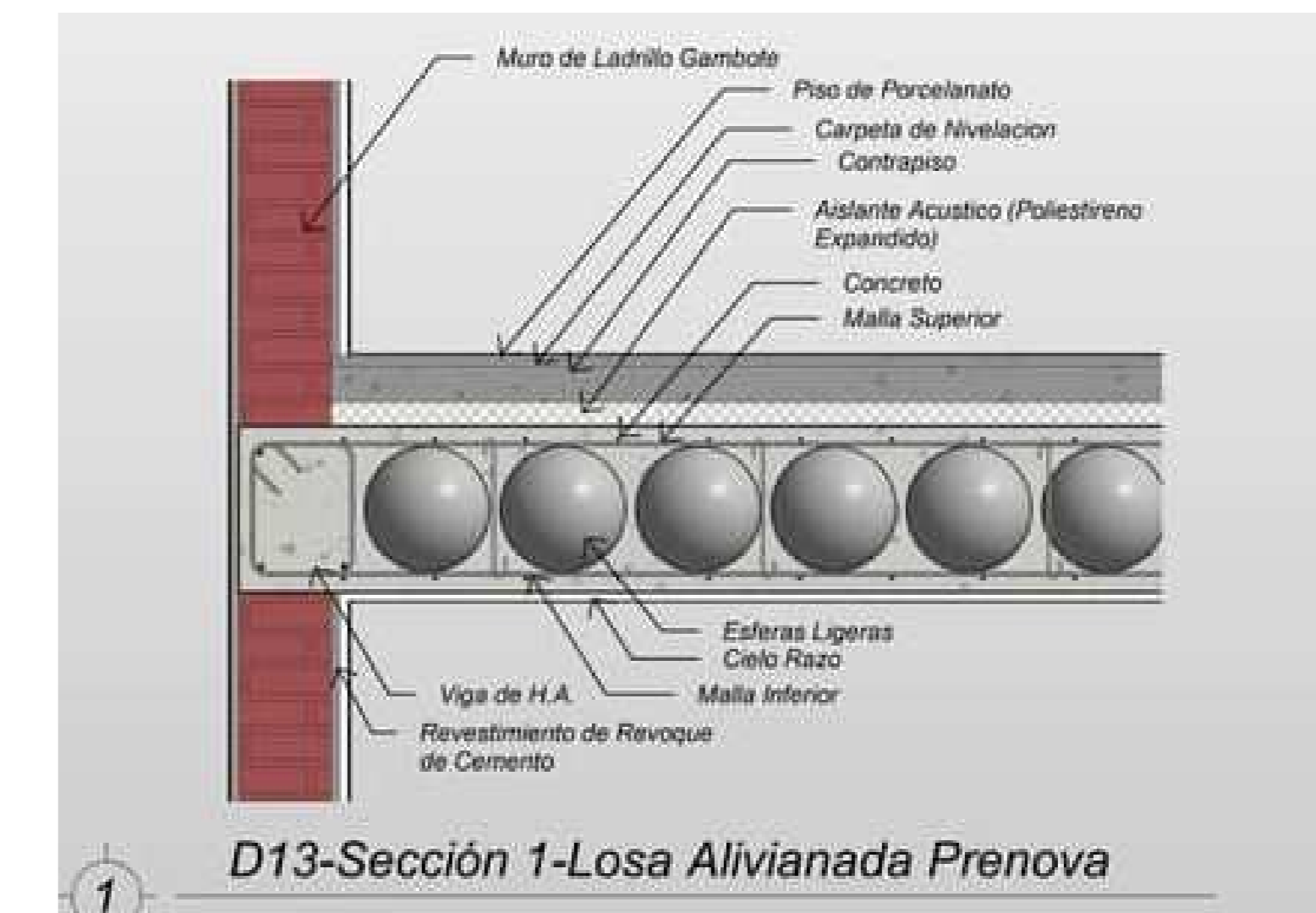
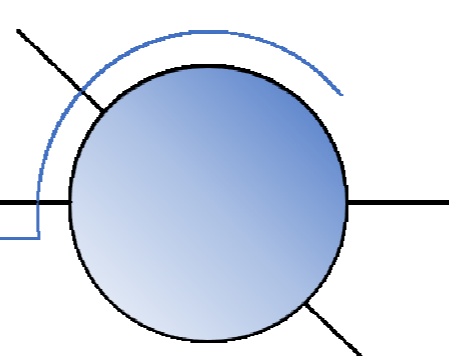

**U.A.J.M.S  
FACULTAD DE  
CIENCIAS  
Y TECNOLOGIA**

PROYECTO DE GRADO 2020

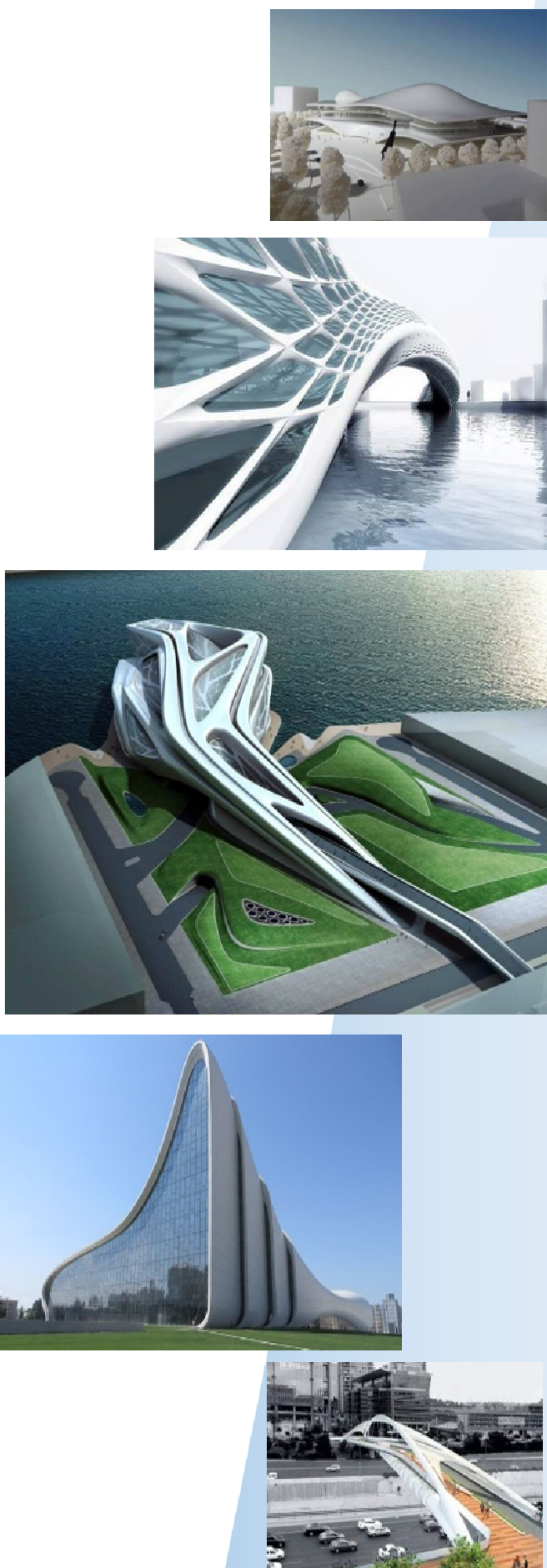

**GRUPO N° 4**

**- DOCENTE:  
ARQ. ÁLVARO  
BORDA.  
- ESTUDIANTE:  
LÓPEZ NAVARRO  
VIVIANA LIZ.**

LAMINA N°

17.1/30

