

**PLANO ESTRUCTURAL DE LOSAS
PLANTA BAJA**

ESC. 1:150

LOSA RETICULADA

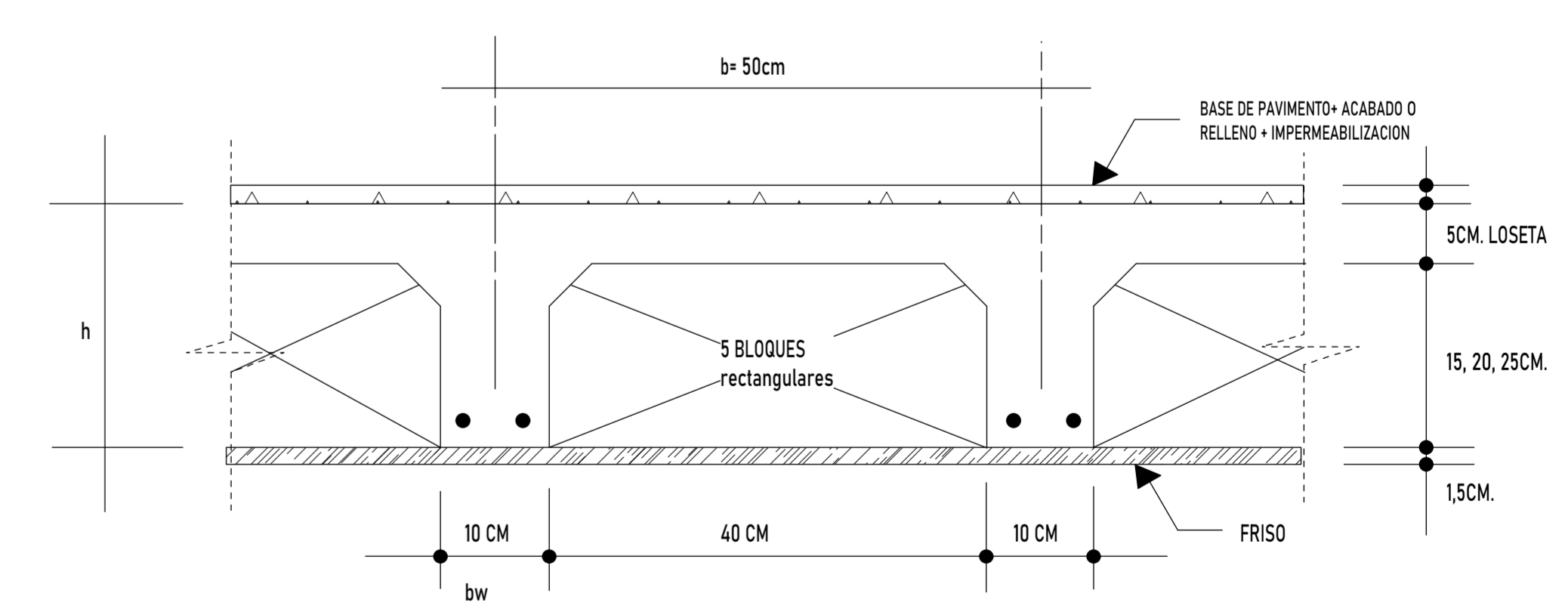

PROYECTO DE GRADO
MERCADO MINORISTA AGROALIMENTARIO EN TARIJA
 PLANO: ESTRUCTURAL DE LOSAS PISO 1
 DOCENTE GUIA: LOPEZ AVILA PEDRO MARCELO
 ESTUDIANTE: MARIA SELENA SULLCA ORTEGA
 ESC:1:150
 N° 12.2

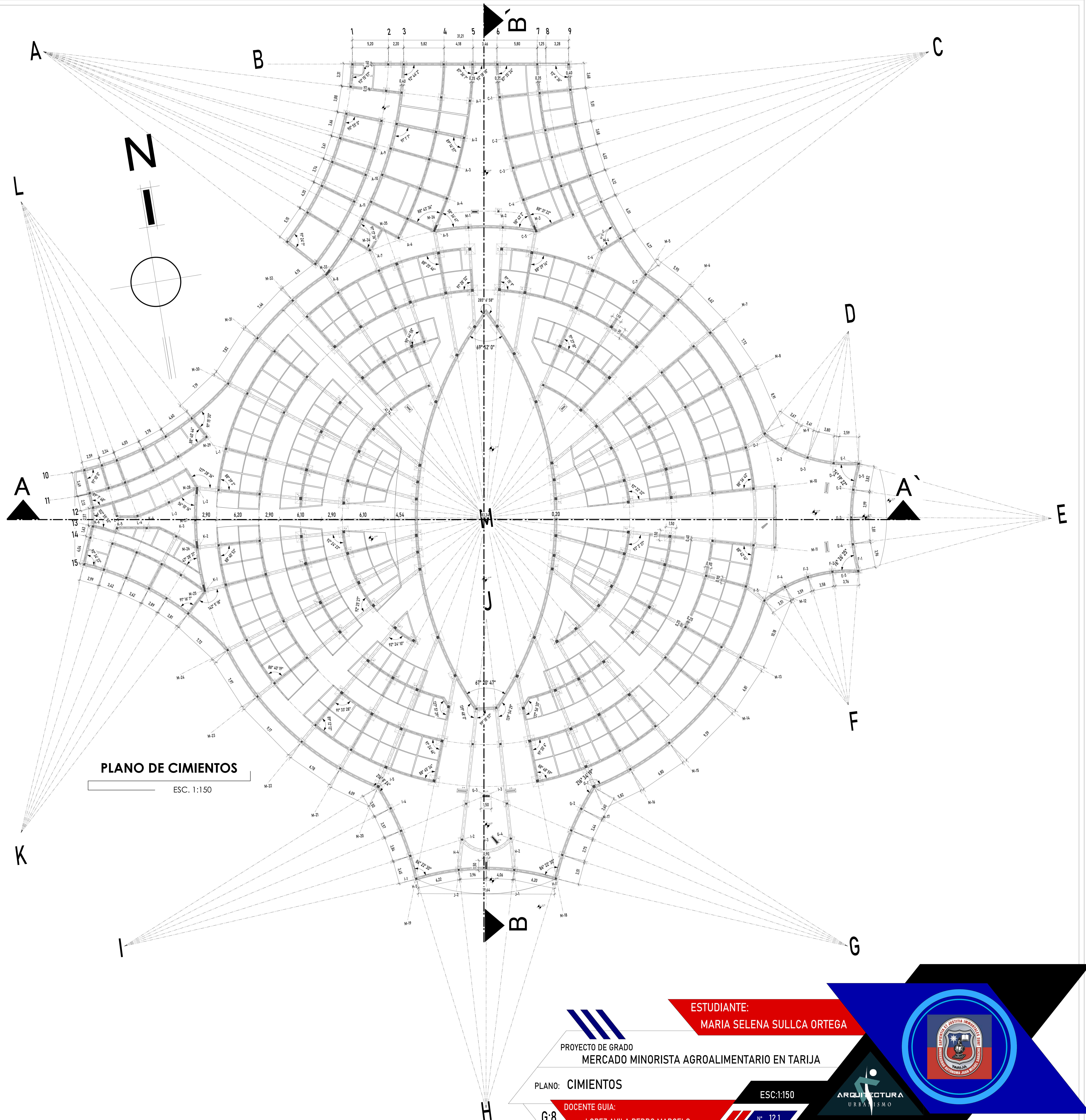
PLANO DE CIMIENTOS

ESC. 1:150

ESTUDIANTE:
MARIA SELENA SULLCA ORTEGA

PROYECTO DE GRADO
MERCADO MINORISTA AGROALIMENTARIO EN TARIJA

PLANO: CIMIENTOS

DOCENTE GUIA:
LOPEZ AVILA PEDRO MARCELO

ESC:1:150

N° 12.1

ARQUITECTURA
URBANISMO



UBICACION Y EMPLAZAMIENTO

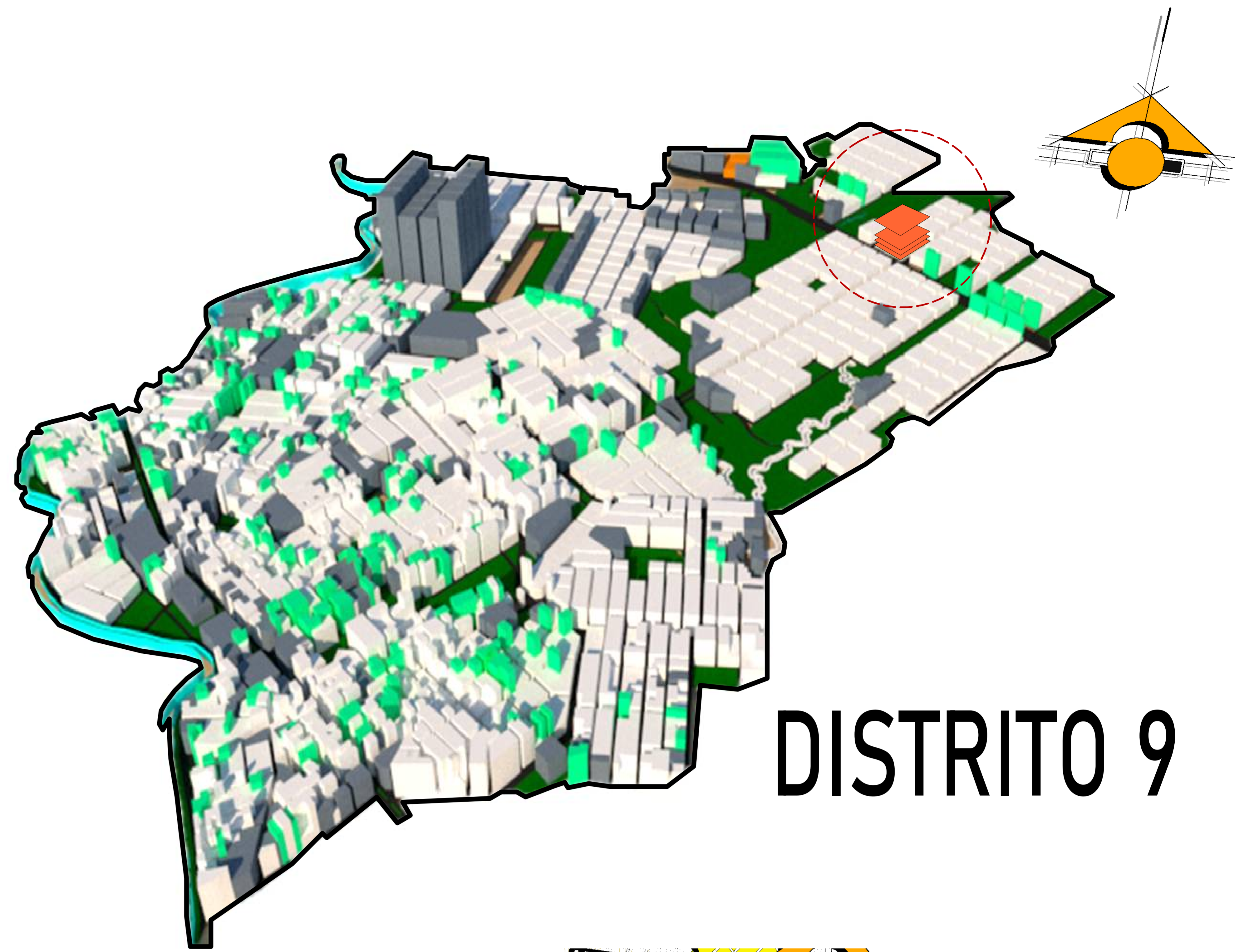
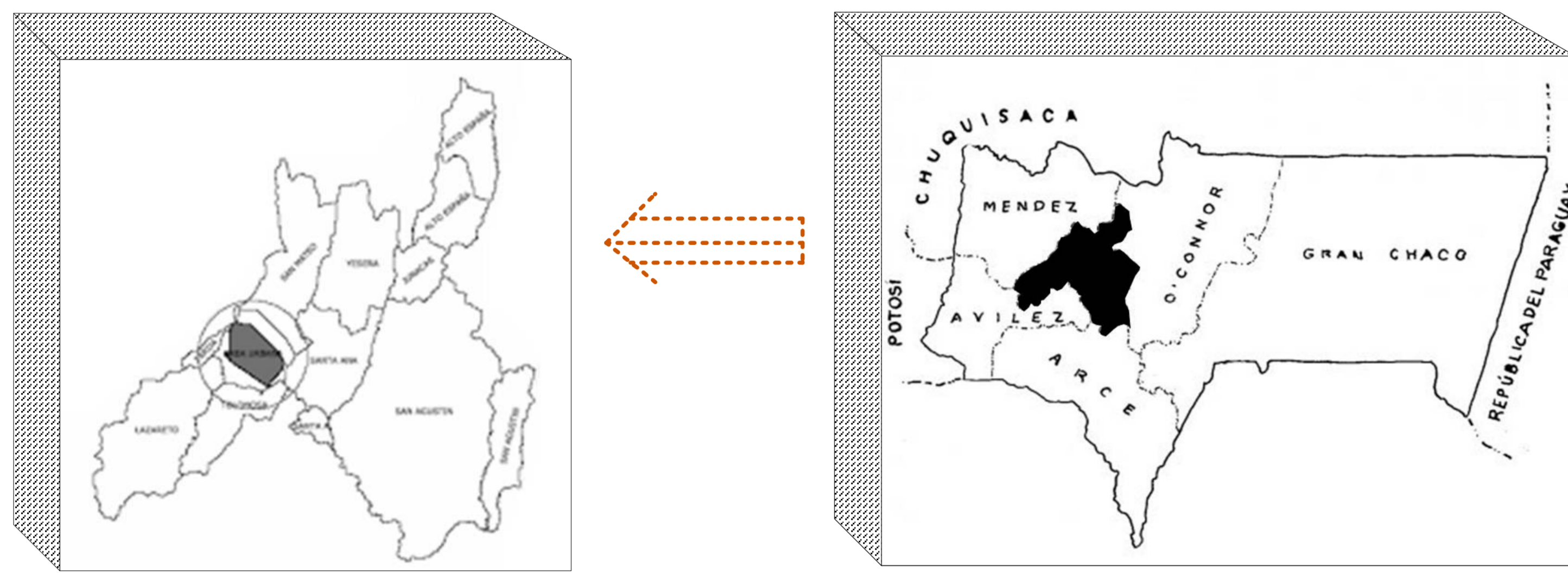
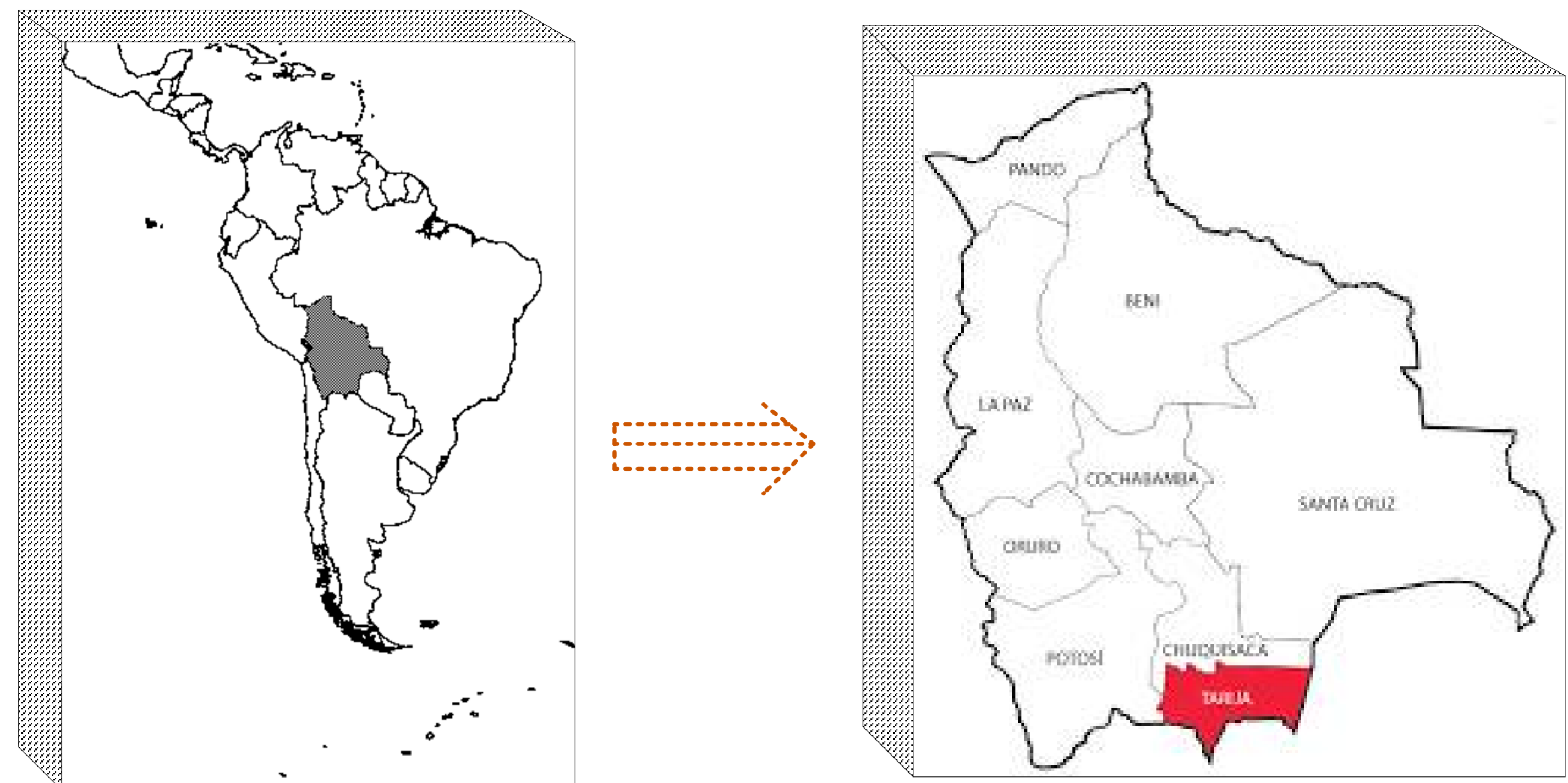

DISTRITO 9

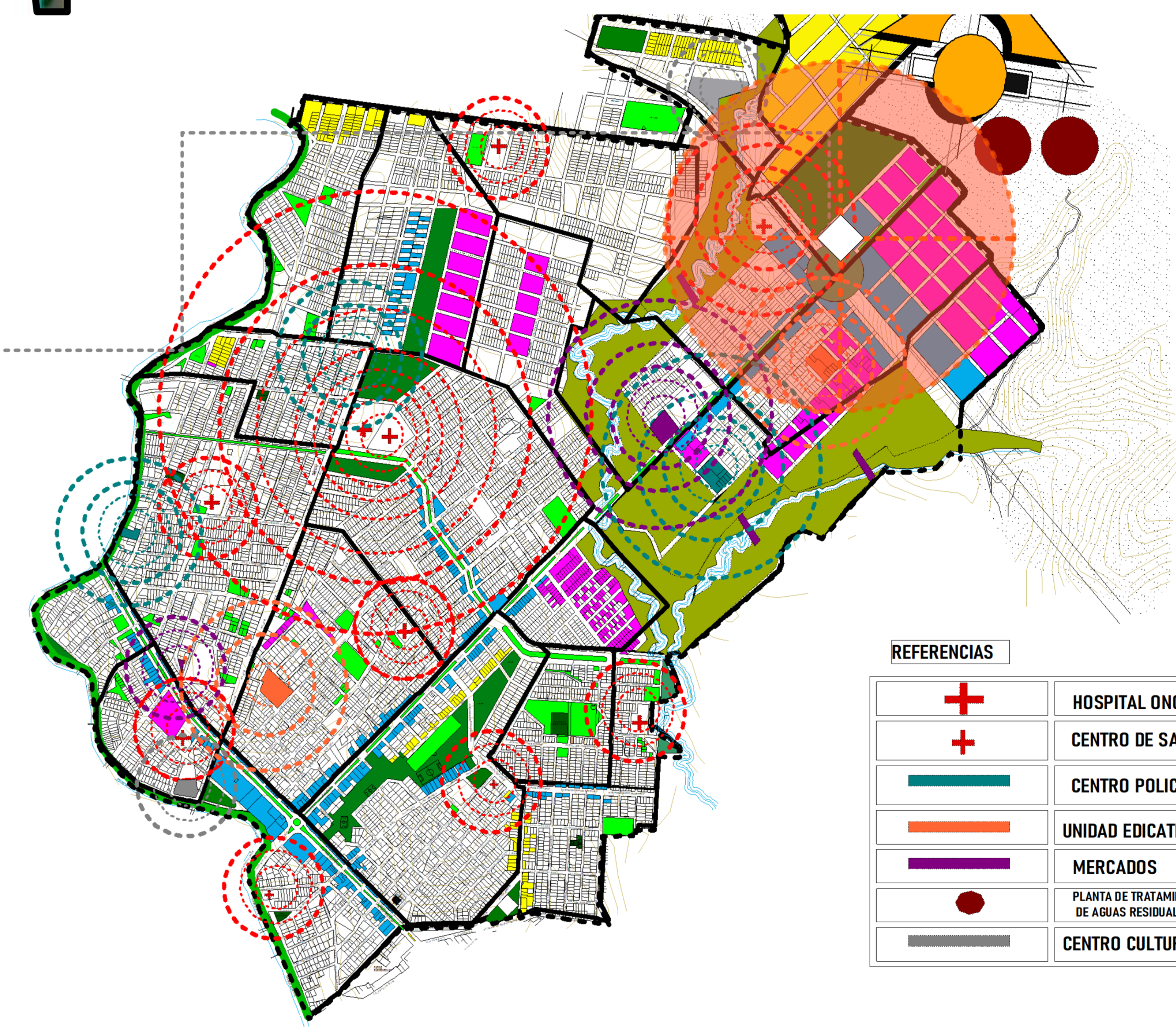

REFERENCIAS	
	HOSPITAL ONCOLOGICO
	CENTRO DE SALUD
	CENTRO POLICIAL
	UNIDAD EDUCATIVA PRIMARIA, SEC
	MERCADOS
	PLANTA DE TRATAMIENTO DE AGUAS RESIDUALES
	CENTRO CULTURAL

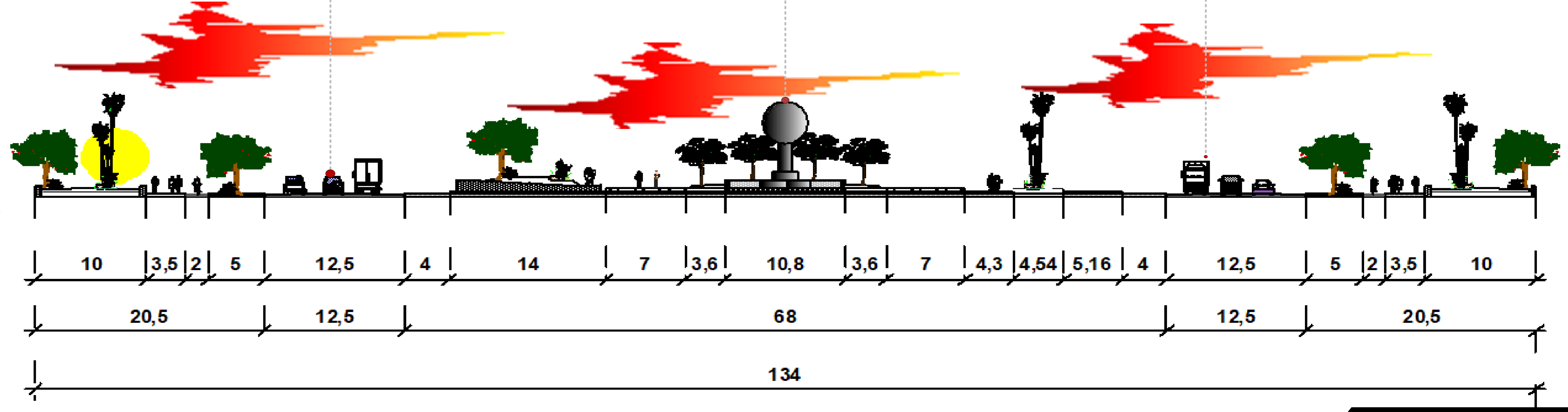
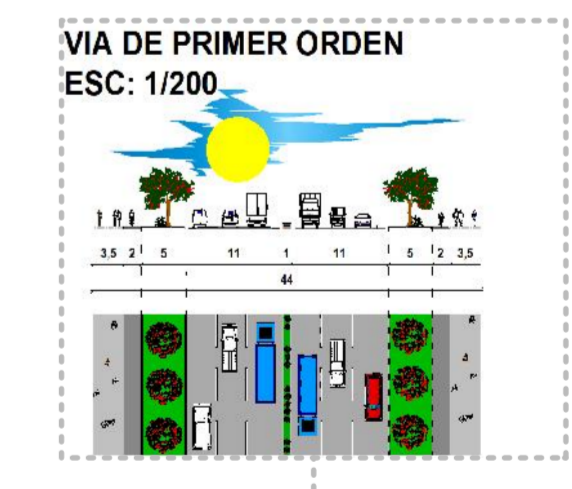
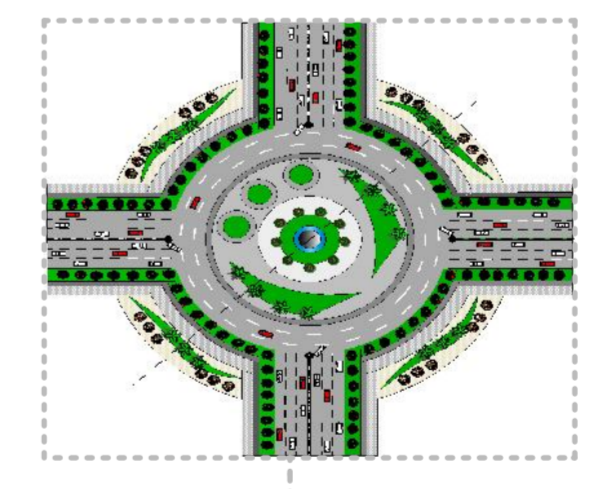
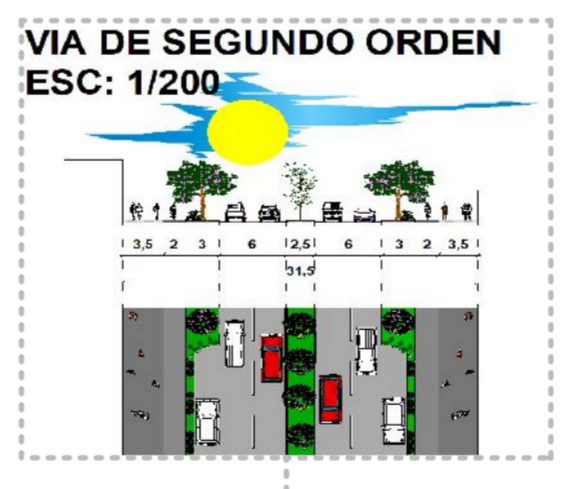
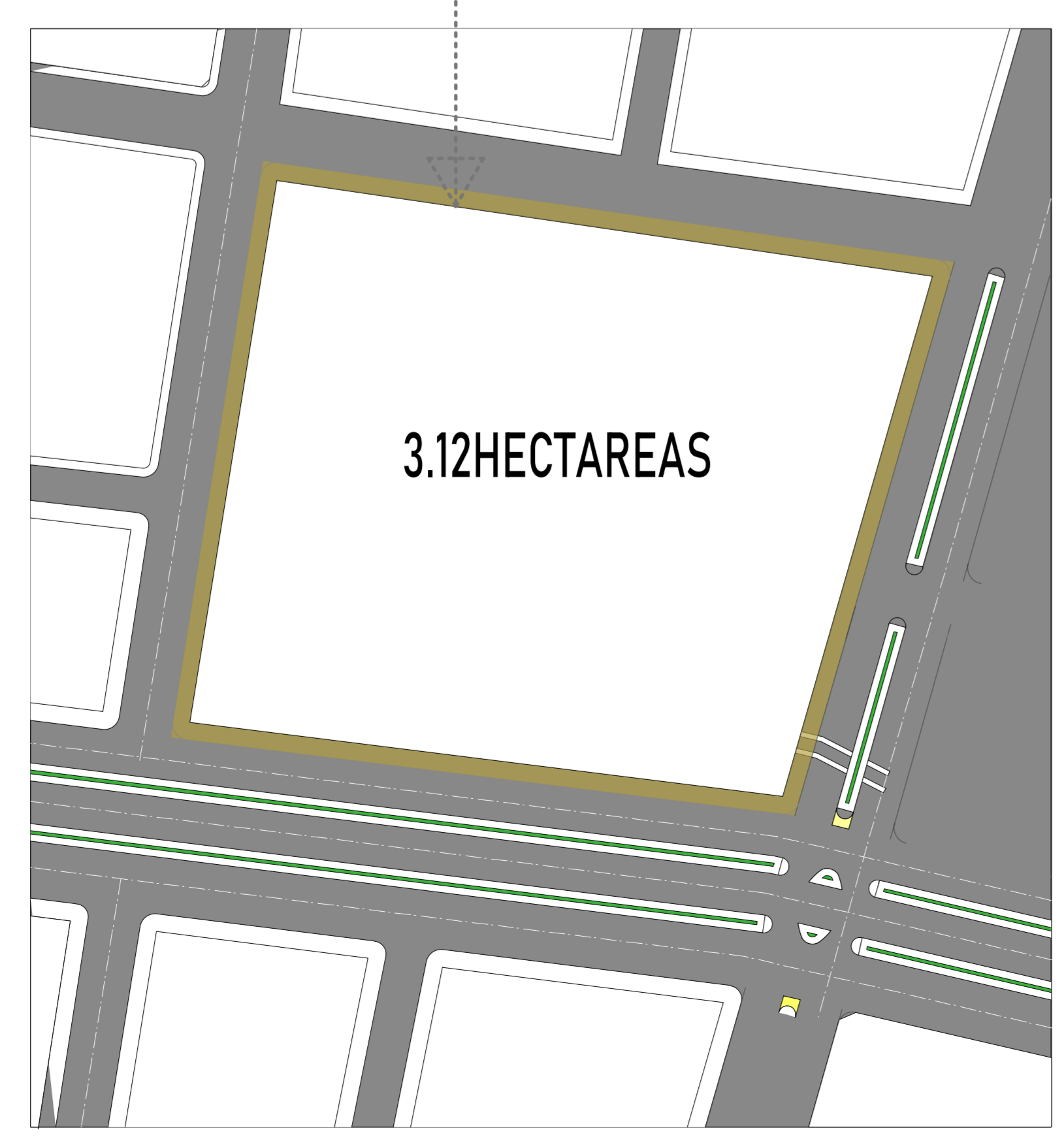
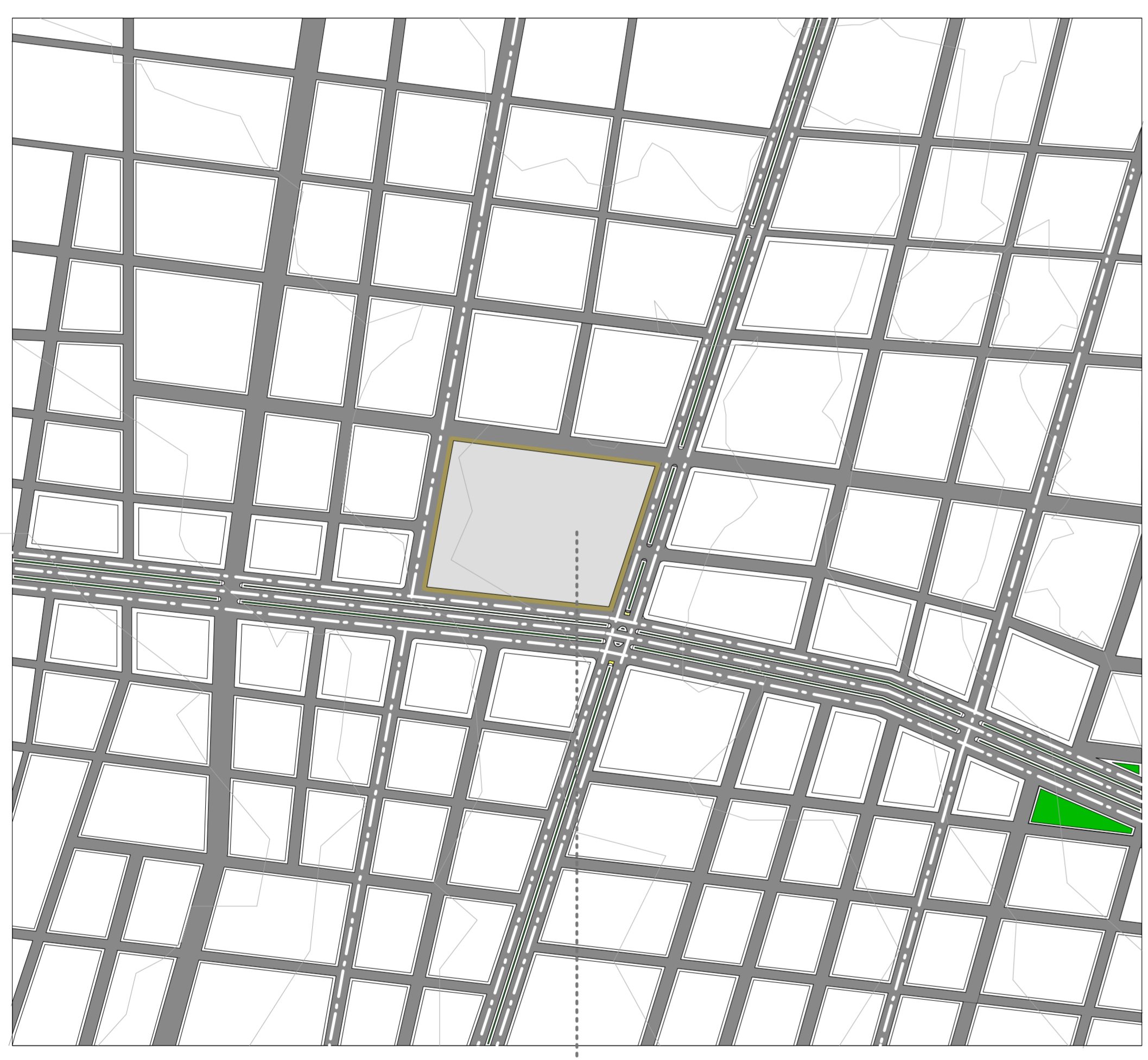

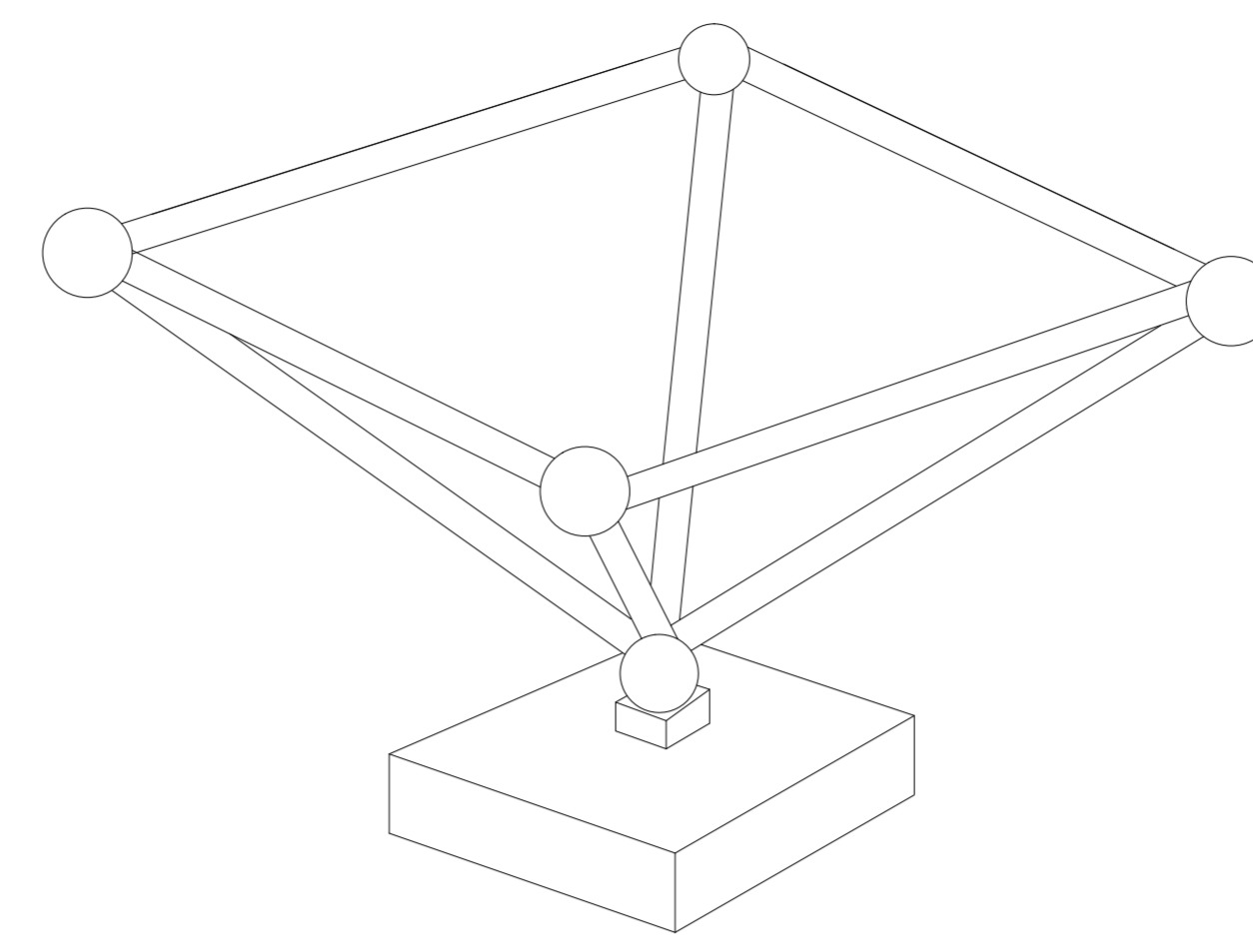
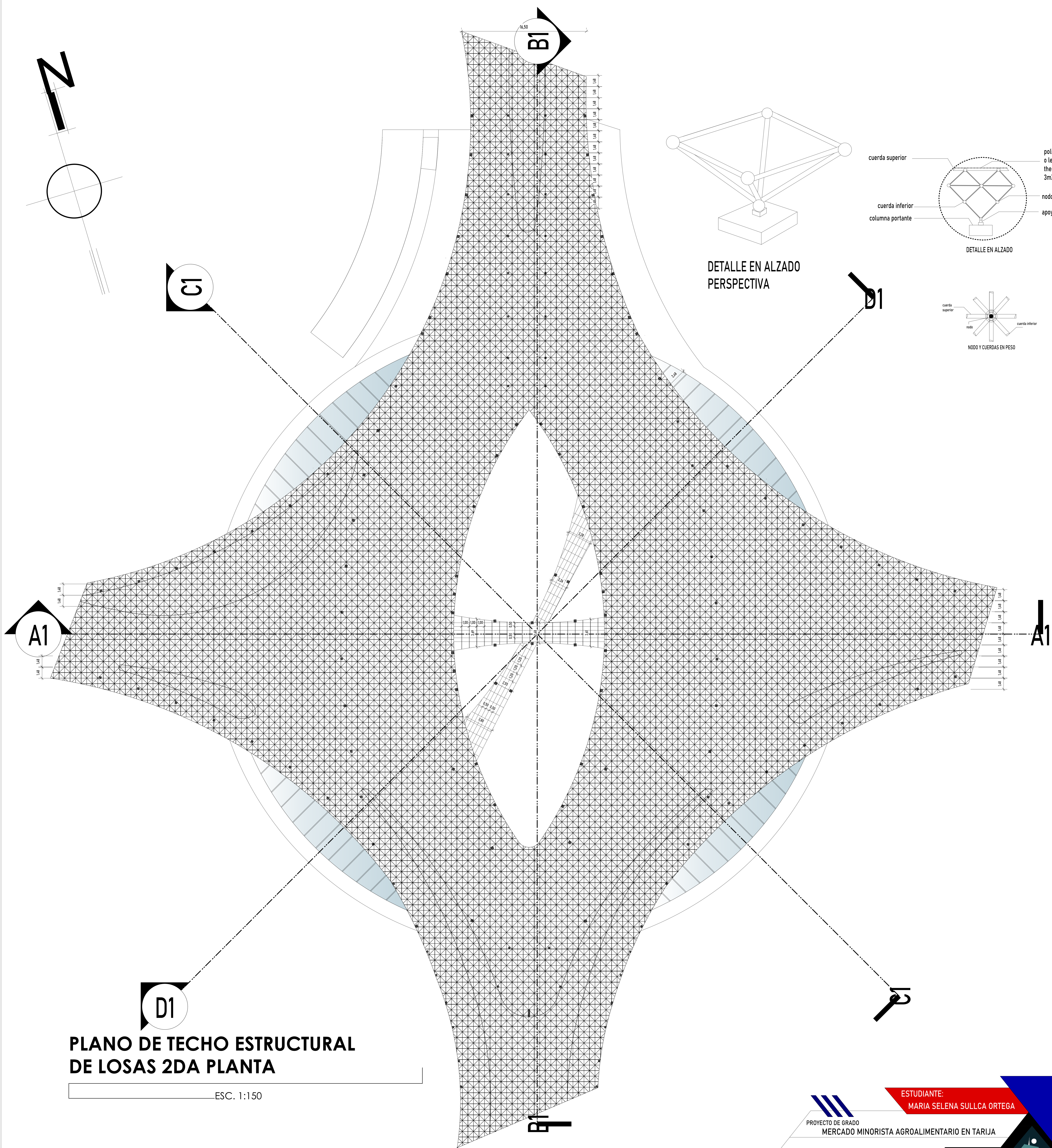
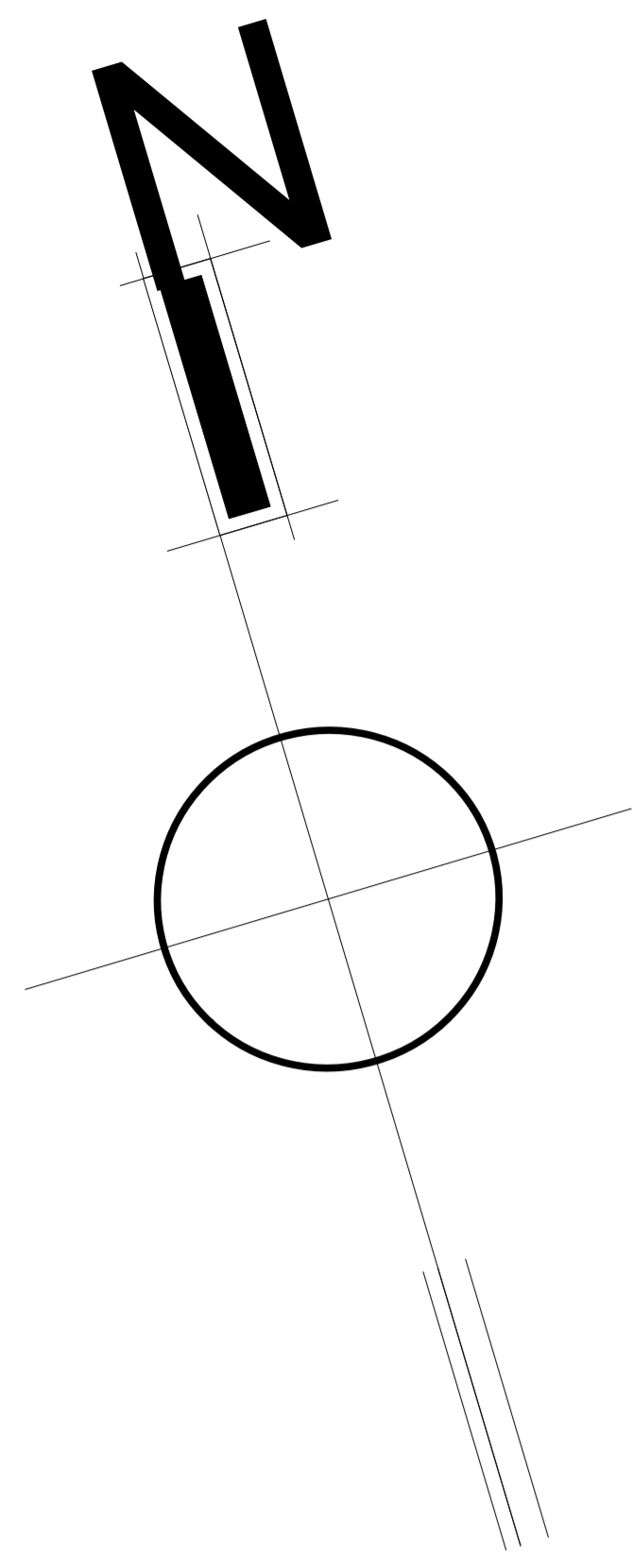

DETALLE EN ALZADO PERSPECTIVA

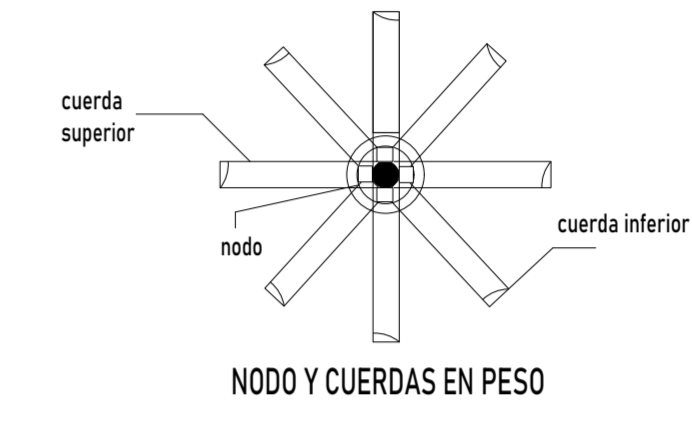
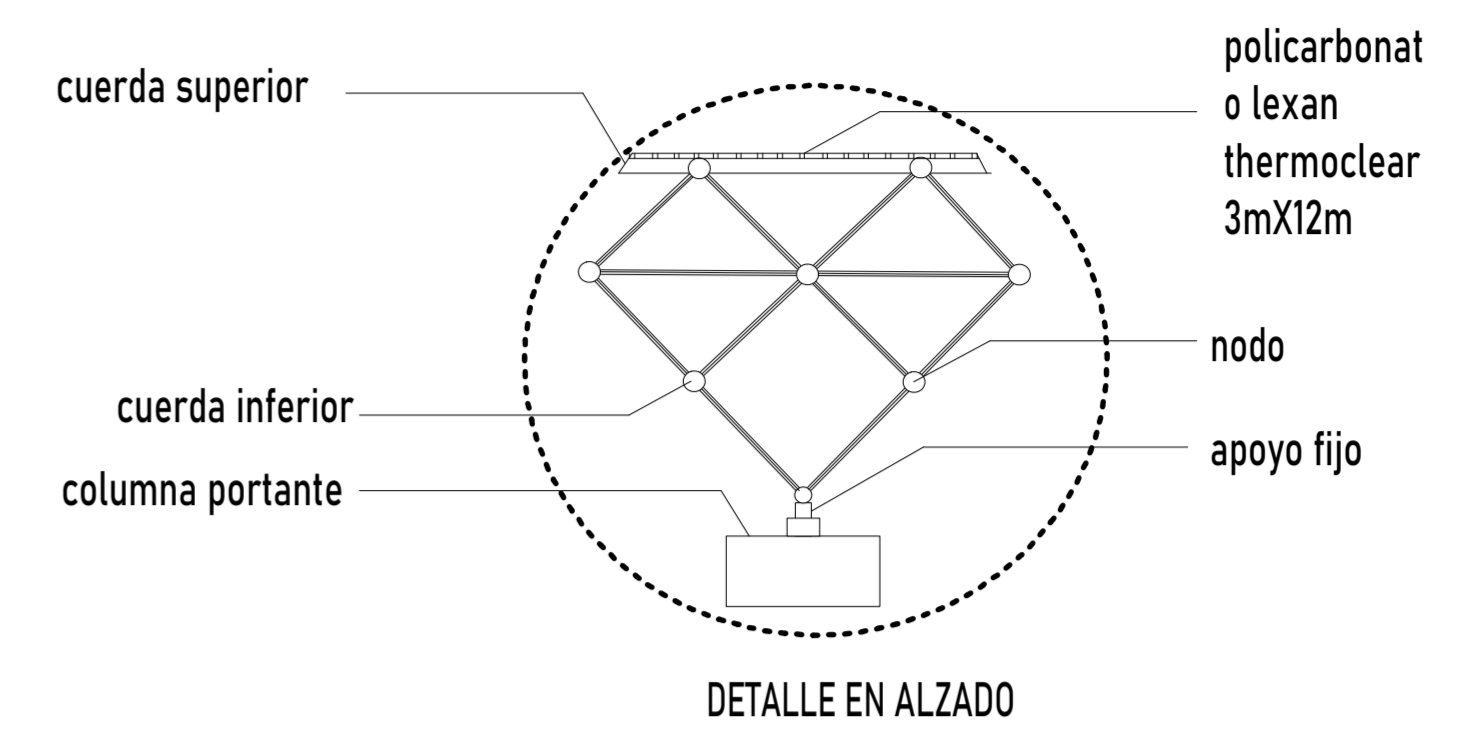

PLANO DE TECHO ESTRUCTURAL DE LOSAS 2DA PLANTA

ESC. 1:150

PROYECTO DE GRADO
MERCADO MINORISTA AGROALIMENTARIO EN TARIJA

PLANO: ESTRUCTURAL DE LOSAS PISO 2

DOCENTE GUIA:
LOPEZ AVILA PEDRO MARCELO

ESTUDIANTE:
MARIA SELENA SULLCA ORTEGA

ESC:1:150

N° 12.3

ARQUITECTURA
URBANA



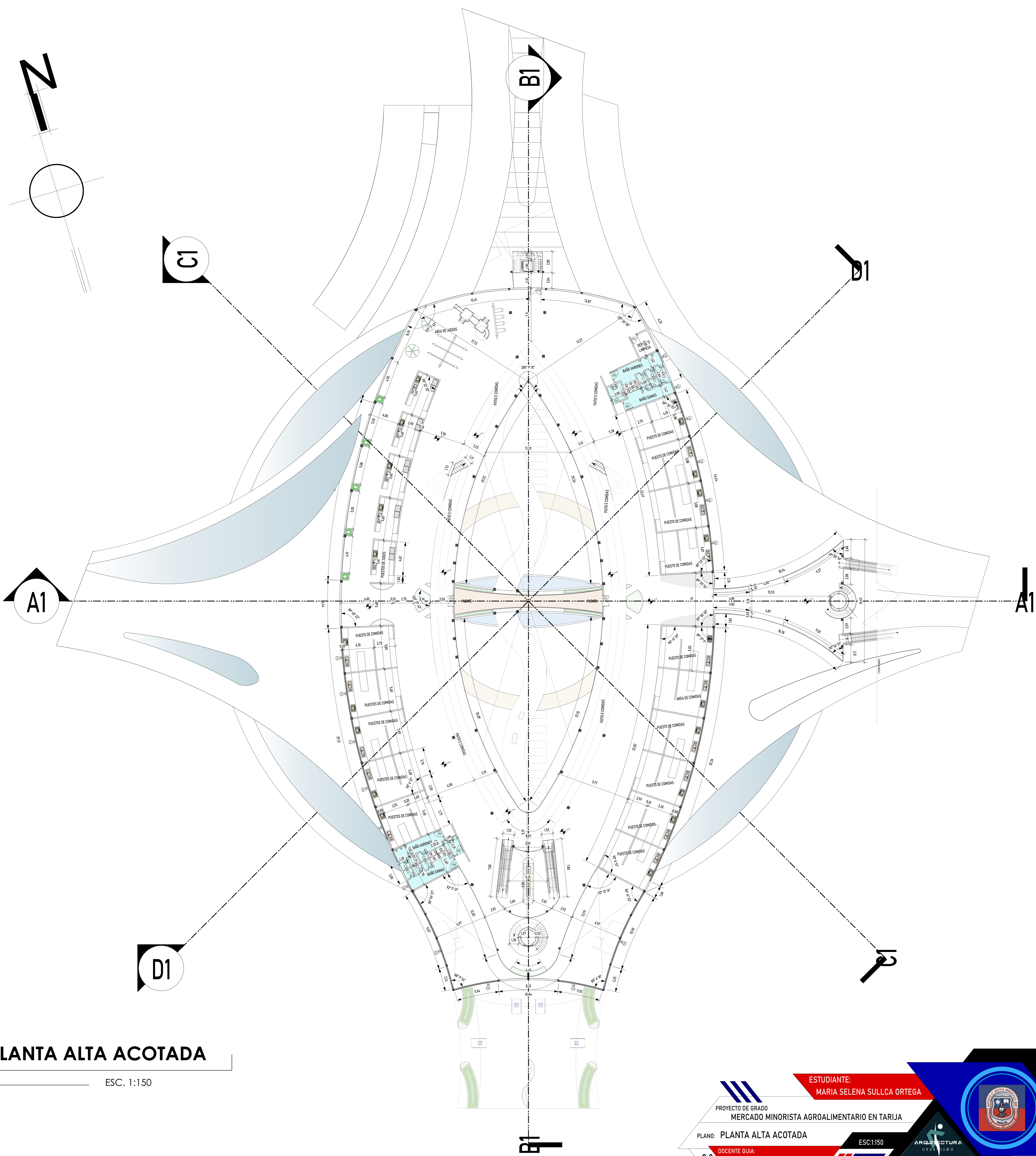
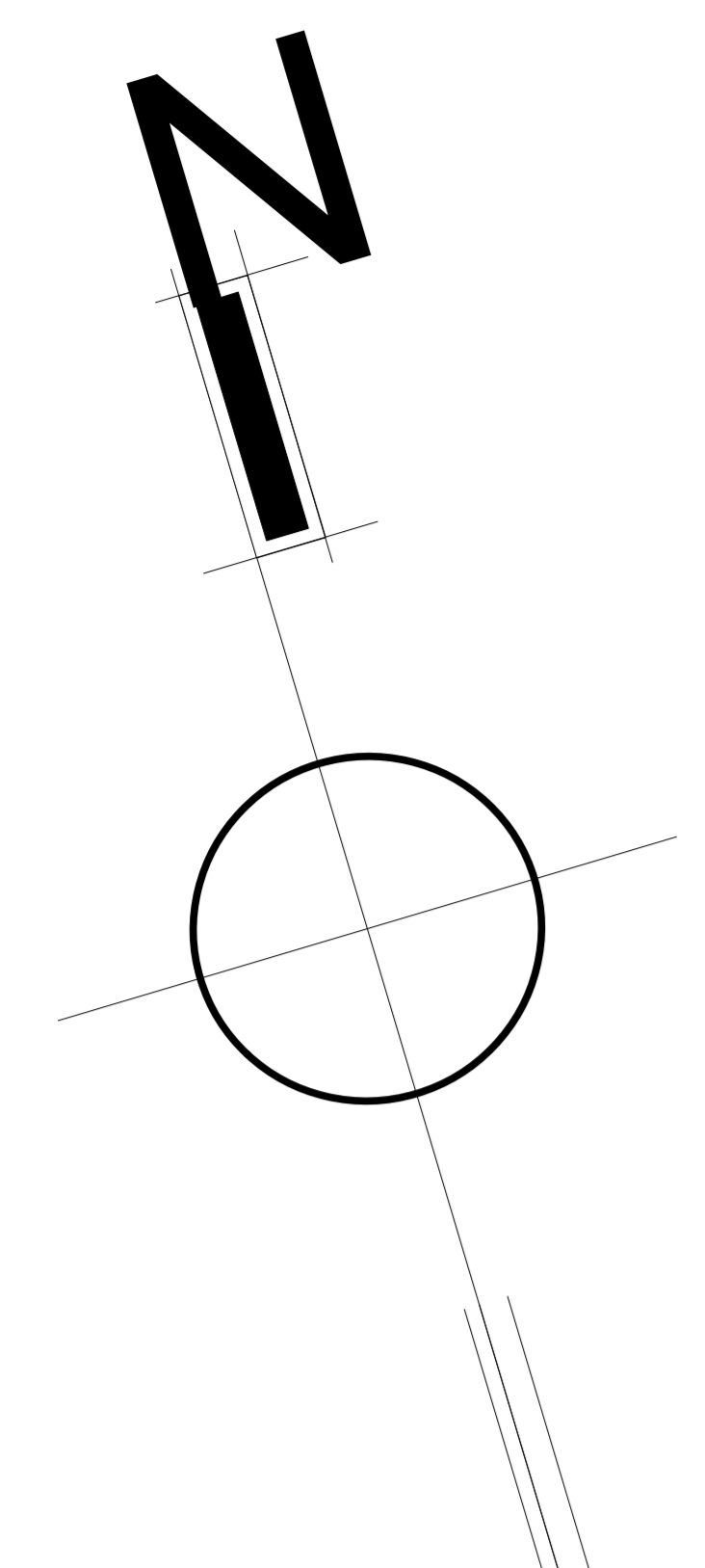

PLANTA ALTA ACOTADA

ESC. 1:150

PROYECTO DE GRADO
MERCADO MINORISTA AGROALIMENTARIO EN TARIJA

PLANO: PLANTA ALTA ACOTADA

DOCENTE GUIA:
LOPEZ AVILA PEDRO MARCELO

ESTUDIANTE:
MARIA SELENA SULLCA ORTEGA





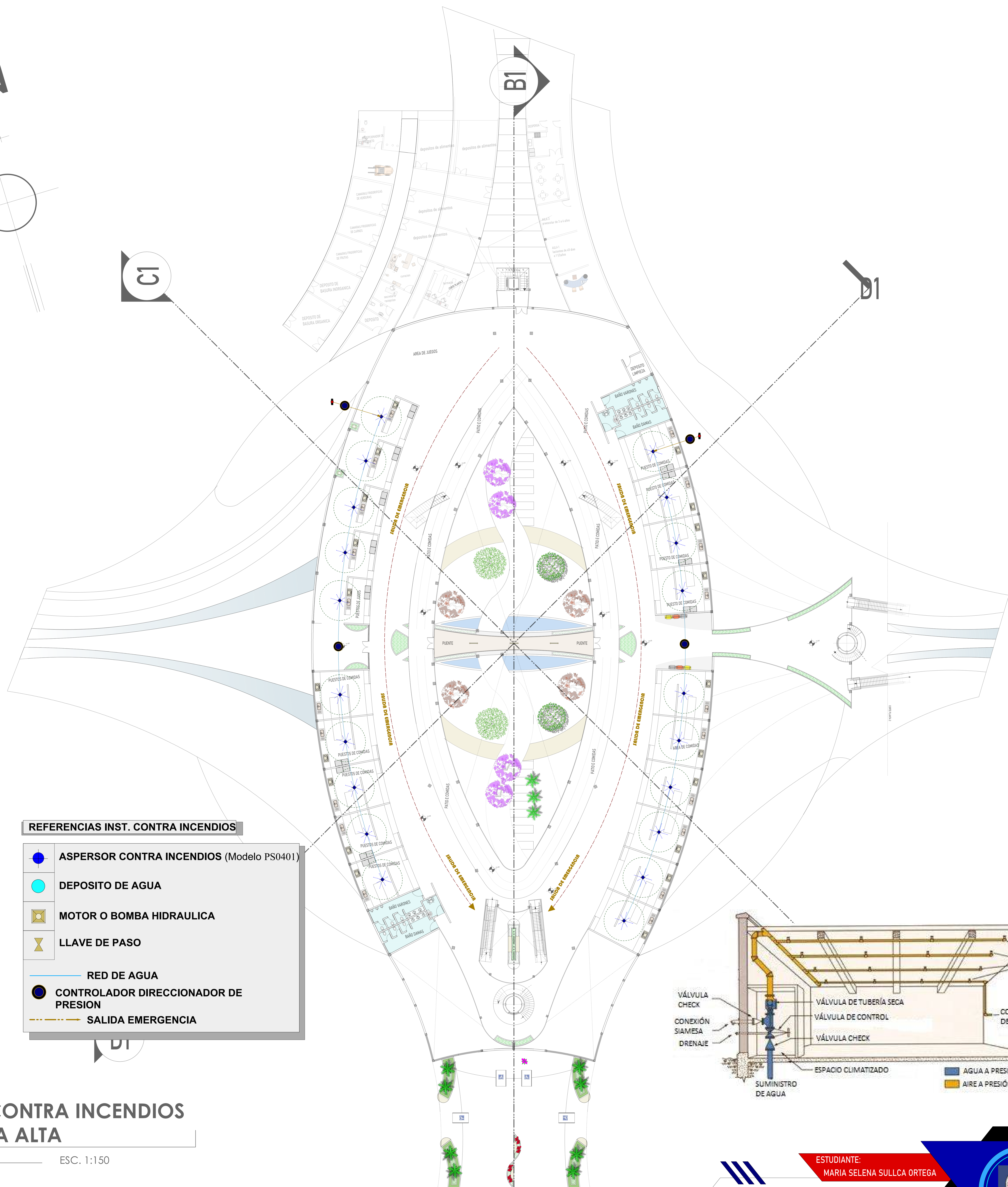
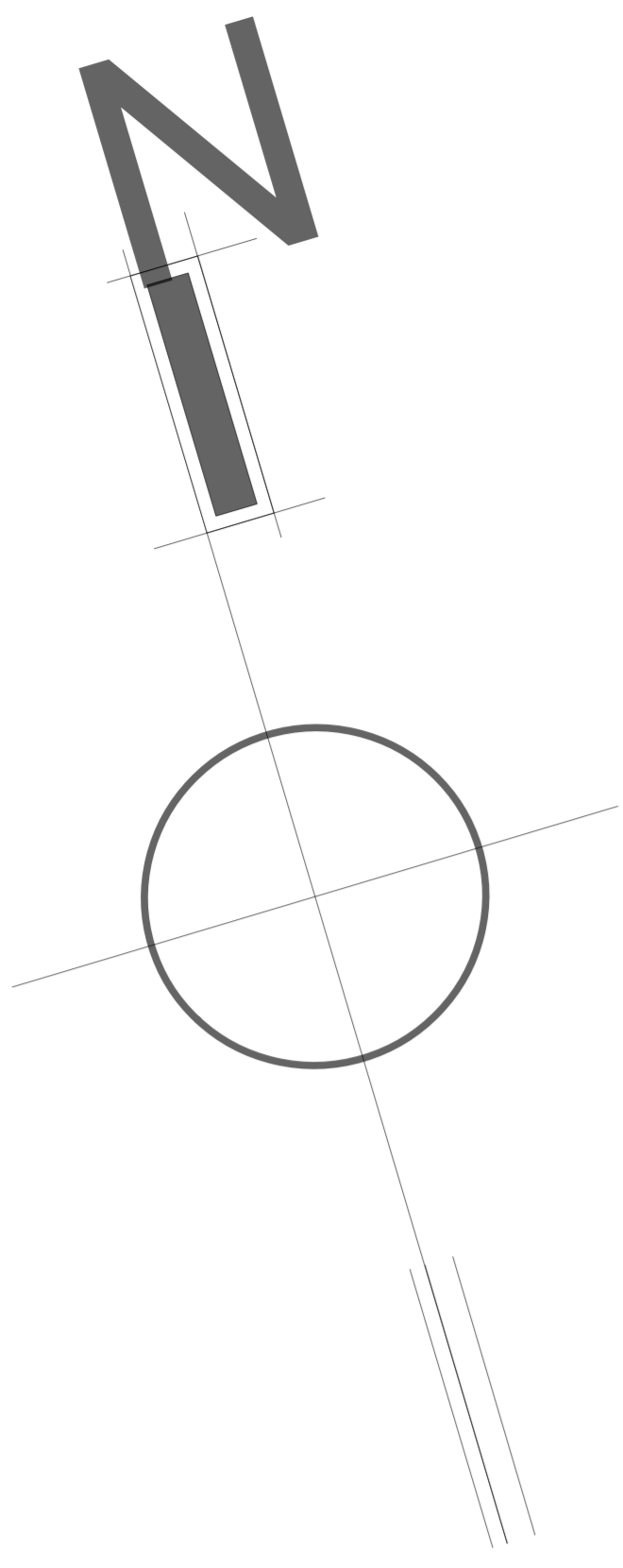

ESC: 1:150

N° 10.4

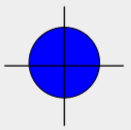

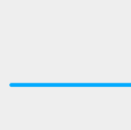

REFERENCIAS INST. CONTRA INCENDIOS

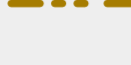
-  ASPERSOR CONTRA INCENDIOS (Modelo PS0401)
-  DEPOSITO DE AGUA
-  MOTOR O BOMBA HIDRAULICA
-  LLAVE DE PASO
-  RED DE AGUA
-  CONTROLADOR DIRECCIONADOR DE PRESION
-  SALIDA EMERGENCIA

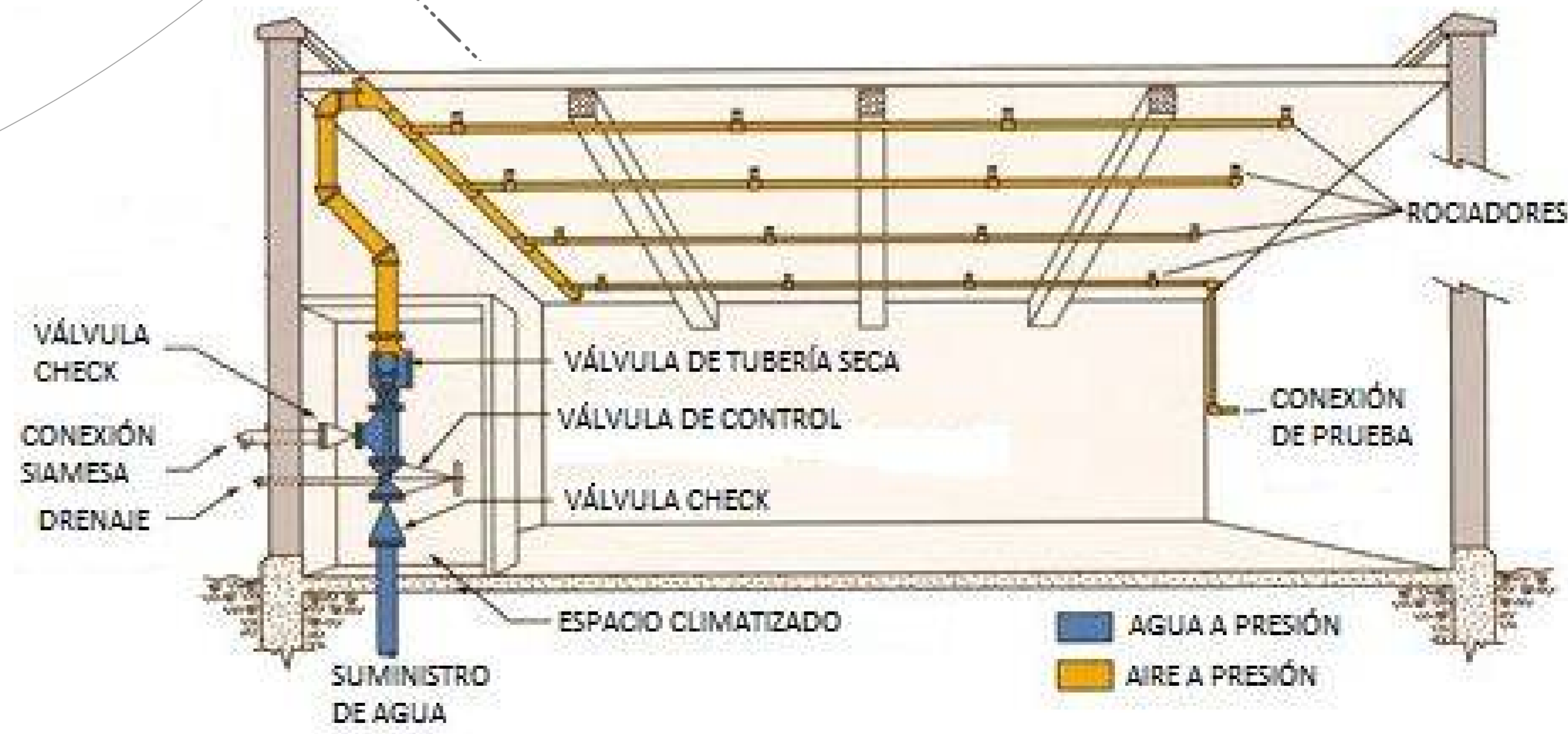

**INST. CONTRA INCENDIOS
PLANTA ALTA**

ESC. 1:150

