

PLANTA BAJA ACOTADA
ESC. 1:100

| CODIFICACION DE VENTANAS | | |
|--------------------------|---------|------------|
| CODIGO | PLANTA | DETALLE 2D |
| V1 | 5.211.6 | |
| V2 | 5.911.6 | |
| V3 | 7.411.6 | |
| V4 | 1.811.6 | |
| V5 | 3.511.6 | |
| V6 | 1012 | |

MURO CORTINA MODULAR

| CODIFICACION DE PUERTAS | | |
|-------------------------|--------|------------|
| CODIGO | PLANTA | DETALLE 2D |
| P1 | 4.027 | |
| P2 | 1.927 | |
| P3 | 1.827 | |
| P4 | 1.827 | |
| P5 | 0.927 | |
| P6 | 0.727 | |
| P7 | 0.927 | |

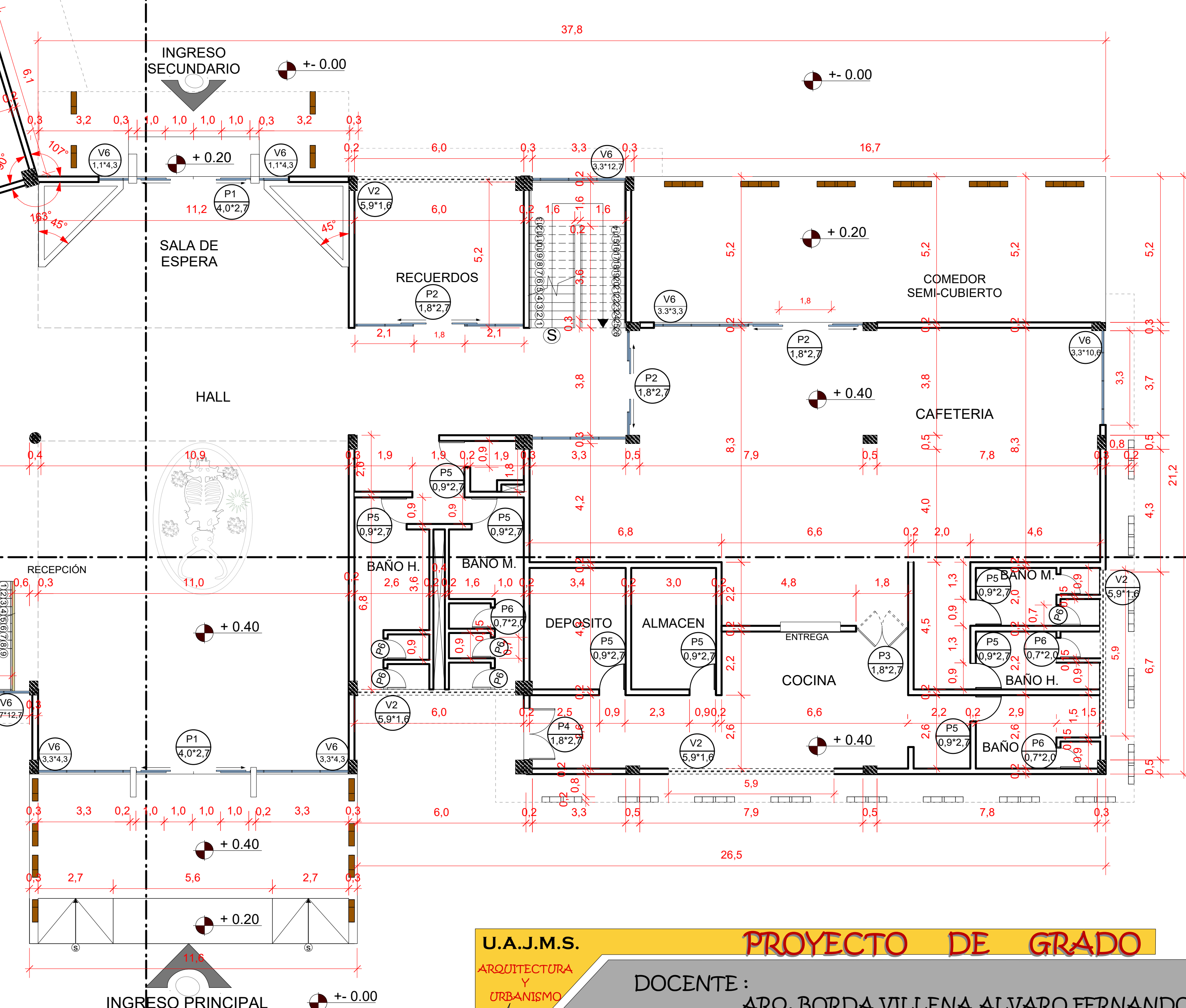

PROYECTO DE GRADO

DOCENTE: ARQ. BORDA VILLENAL ALVARO FERNANDO
UNIVERSITARIA: CLAUDIA EUGENIA TITO VIQUE



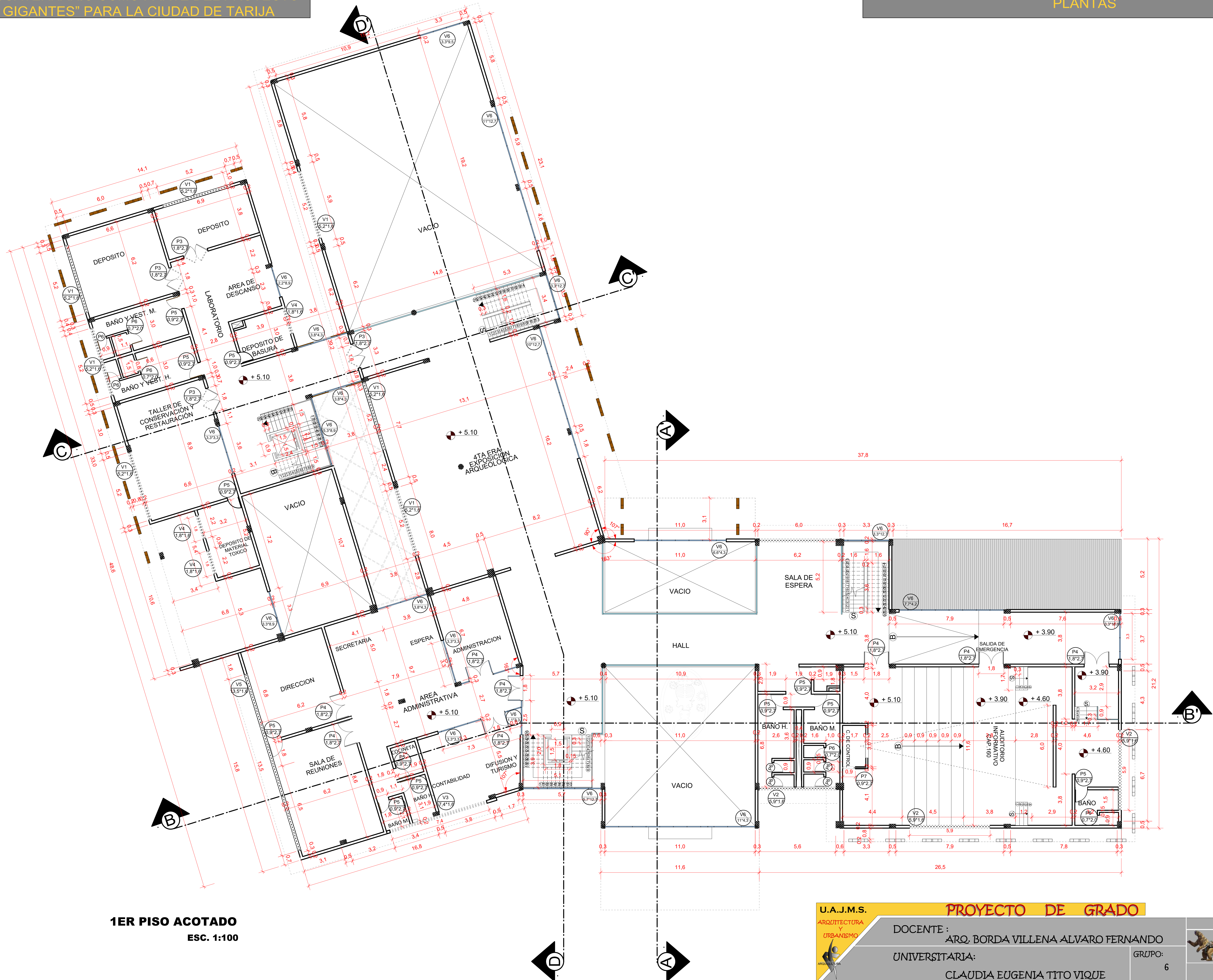
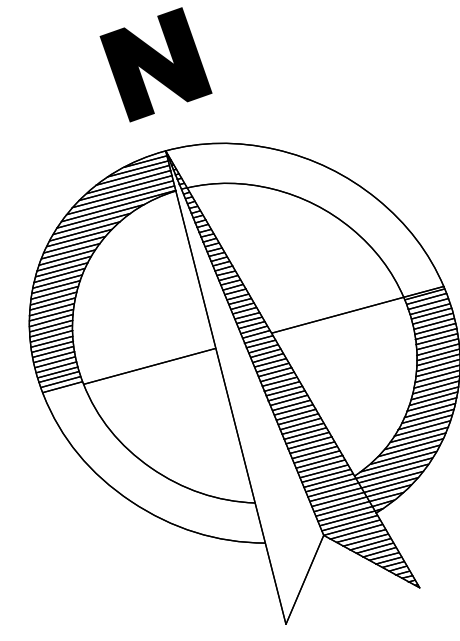

1ER PISO ACOTADO
ESC. 1:100



PROYECTO DE GRADO
 DOCENTE : ARQ. BORDA VILLENA ALVARO FERNANDO
 UNIVERSITARIA :
 CLAUDIA EUGENIA TITO VIQUE

GRUPO: 6



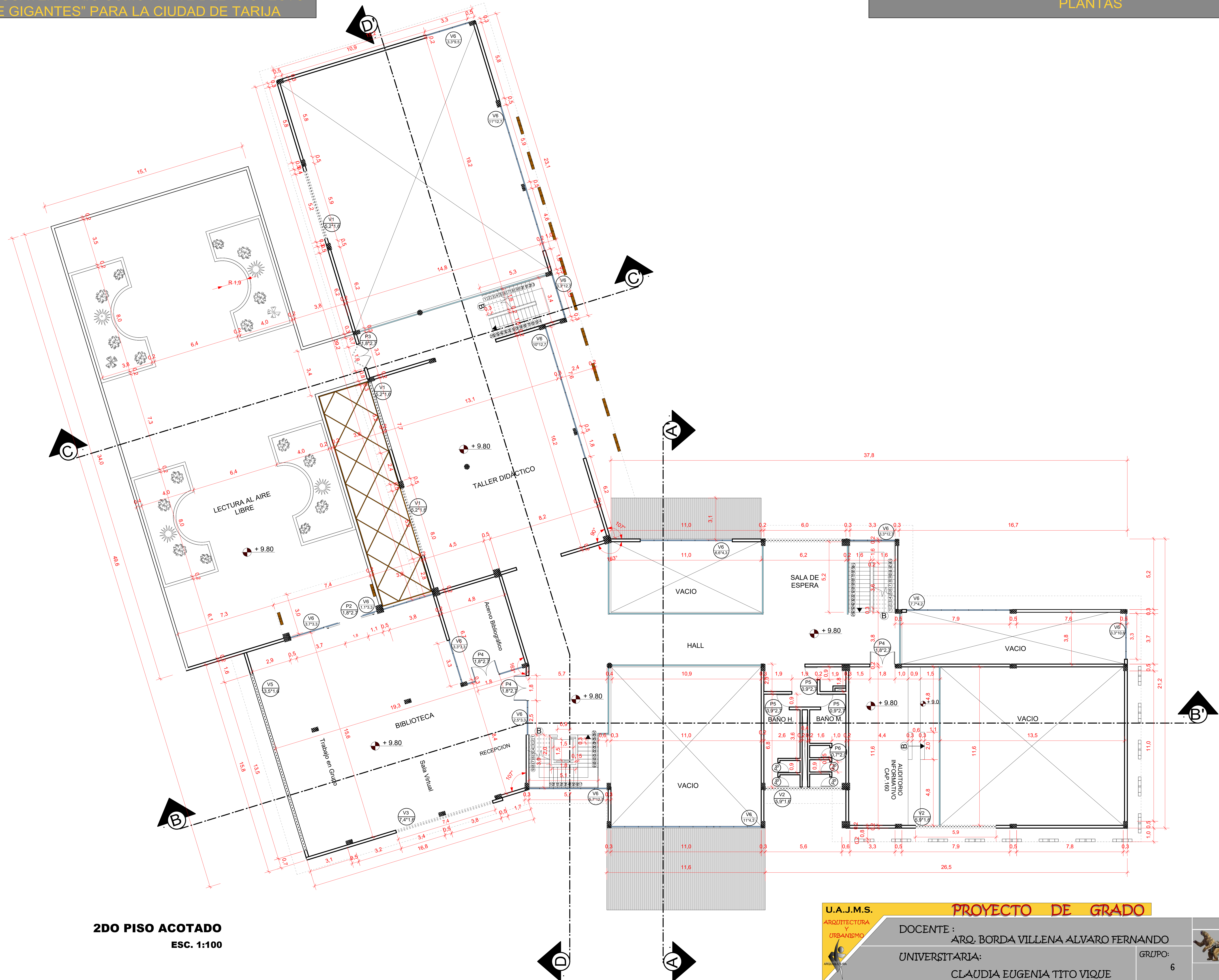
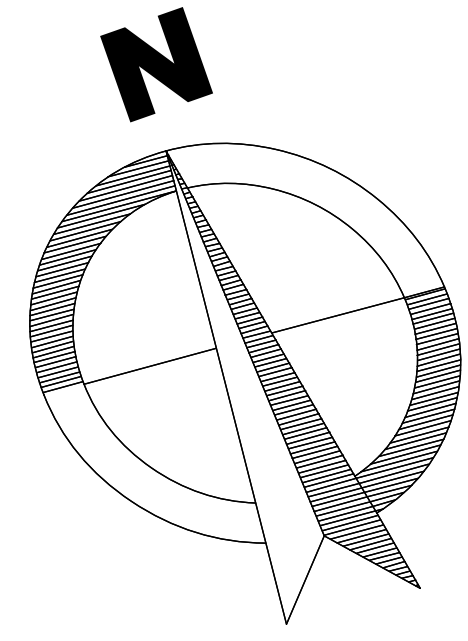

2DO PISO ACOTADO
ESC. 1:100



PROYECTO DE GRADO

DOCENTE : ARQ. BORDA VILLENA ALVARO FERNANDO
UNIVERSITARIA: CLAUDIA EUGENIA TITO VIQUE

GRUPO: 6



LAMINA: 10.6/16

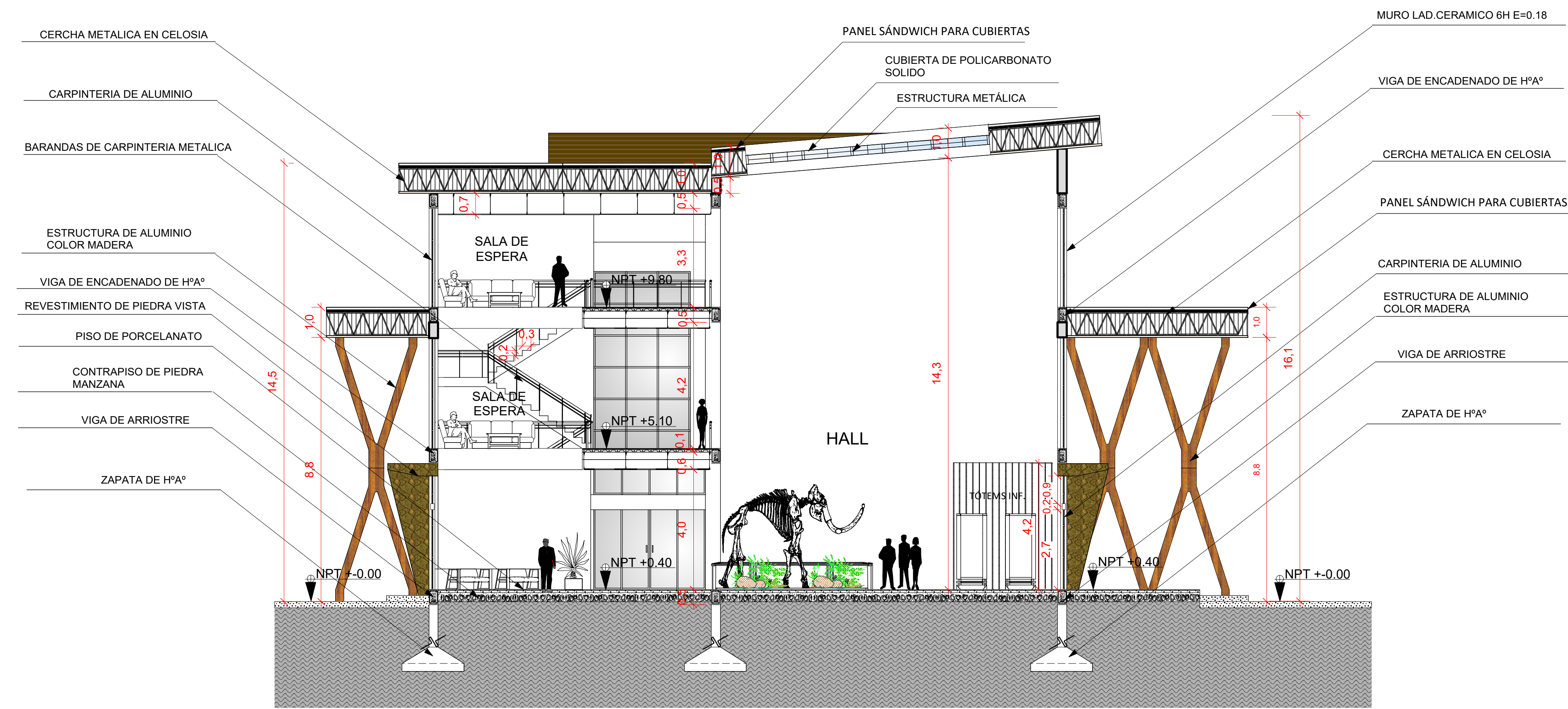

CORTE A - A'
ESC. 1:100



CORTE B - B'
ESC. 1:100

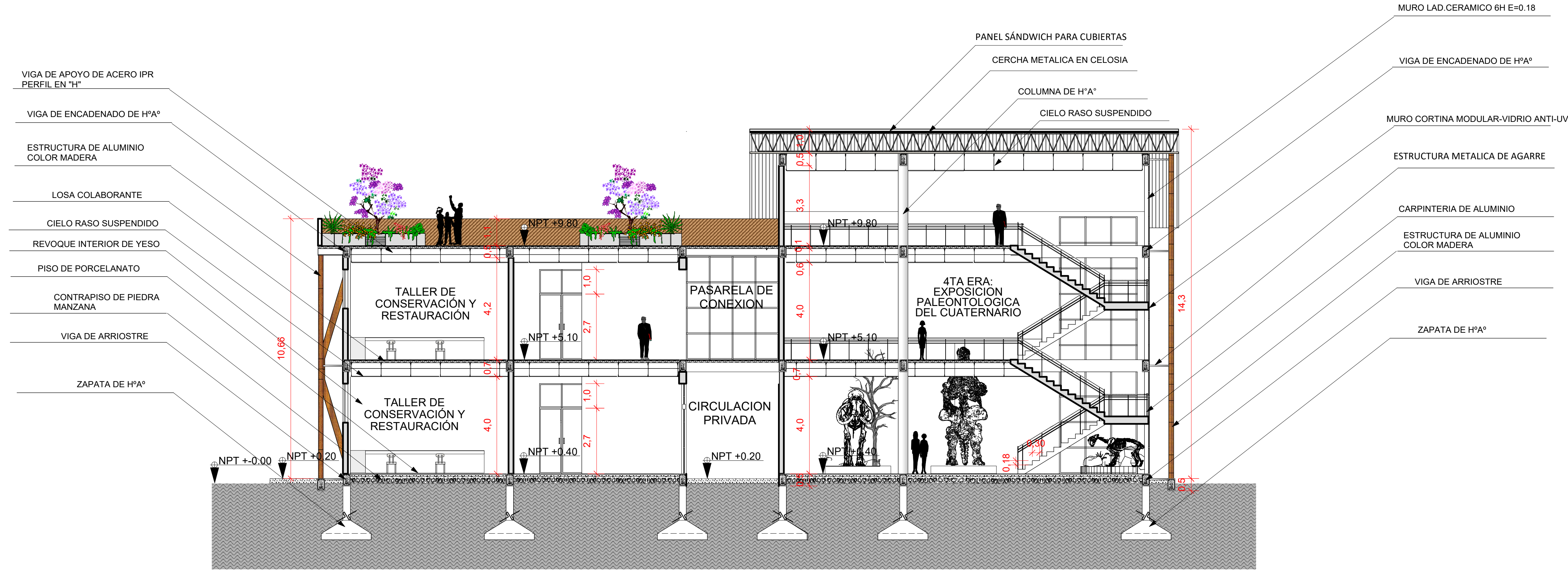

CORTE C - C'
ESC. 1:100

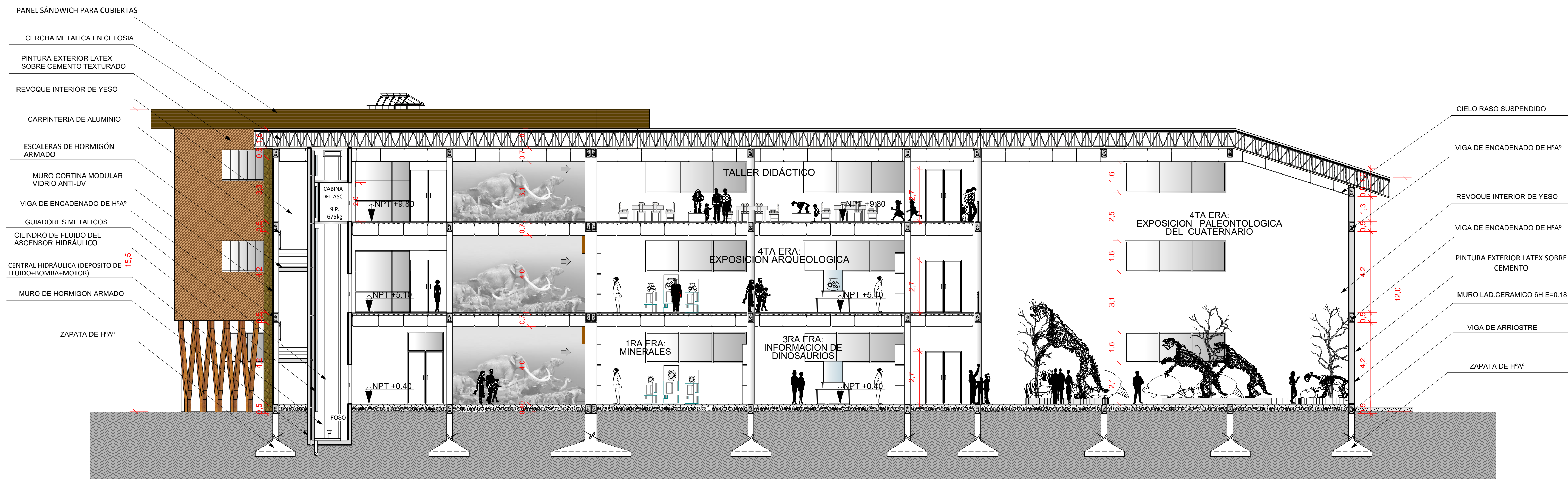

CORTE D - D'
ESC. 1:100





VISTA FRONTAL
ESC. 1:100

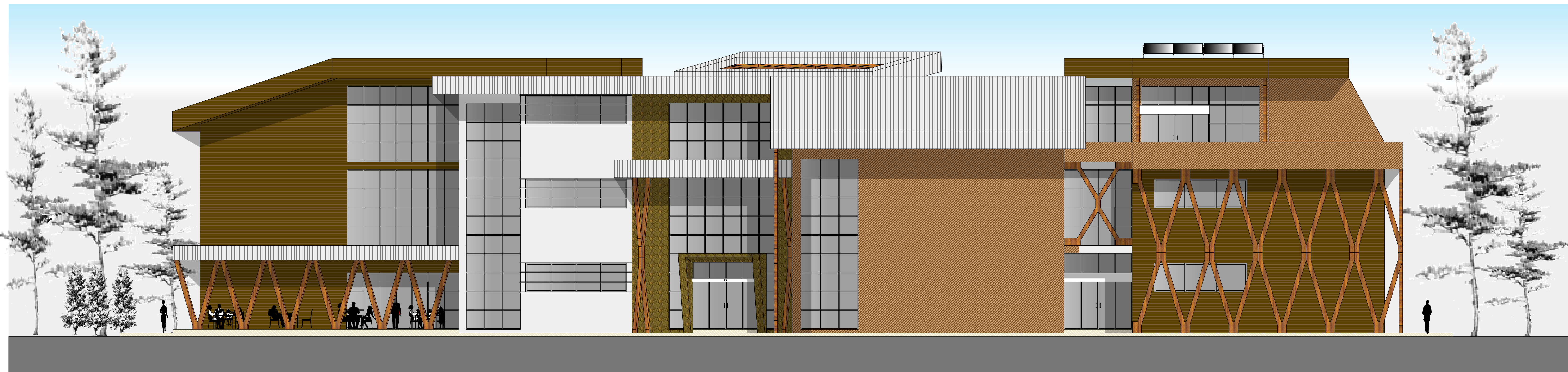

VISTA POSTERIOR
ESC. 1:100



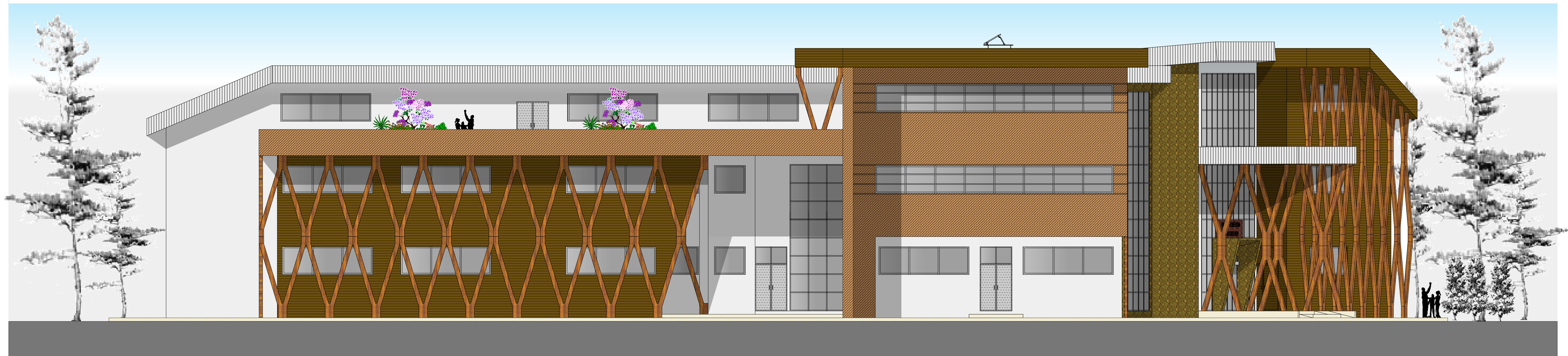

VISTA LATERAL OESTE
ESC. 1:100

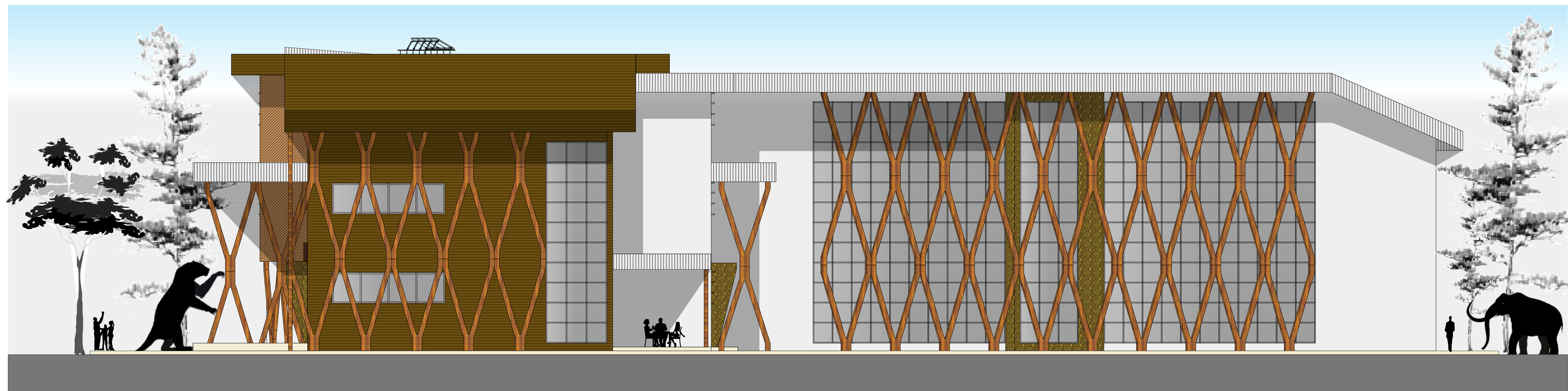

VISTA LATERAL ESTE
ESC. 1:100



PERSPECTIVAS EXTERIORES



PERSPECTIVAS INTERIORES



HALL DE INGRESO



INGRESO A LAS SALAS DE EXPOSICION



EXPOSICION DE MINERALES



EXPOSICION ARQUEOLOGICA



EXPOSICION PALEONTOLOGICA DEL CUATERNARIO



EXPOSICION PALEONTOLOGICA DEL CUATERNARIO



CAFETERIA



BIBLIOTECA



ÁREA ADMINISTRATIVA



TALLER DE CONSERVACION Y RESTAURACION



ÁREA DE SEGURIDAD



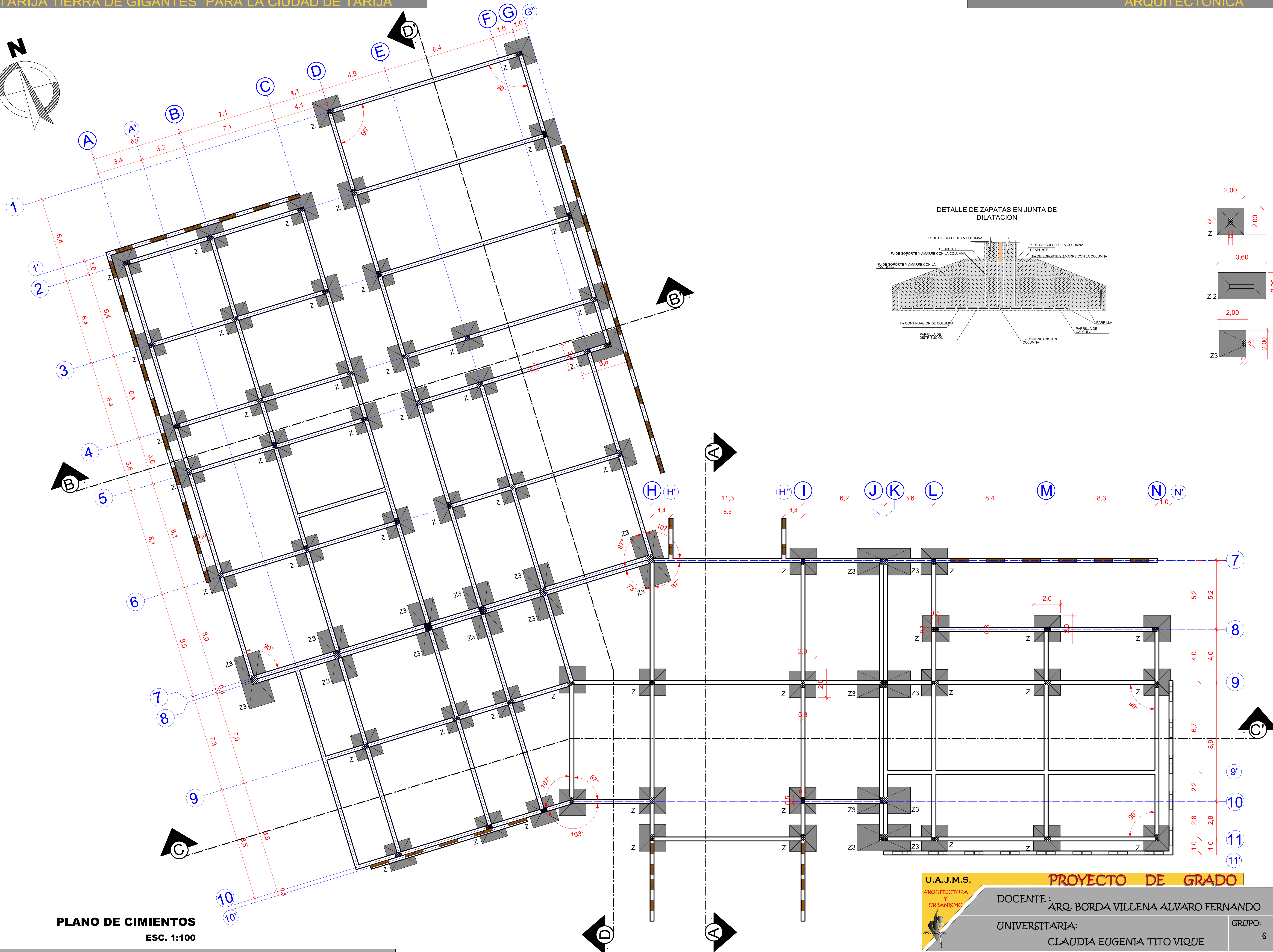
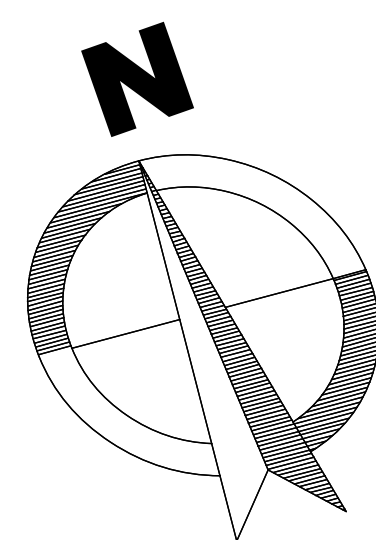

DETALLE DE ZAPATAS EN JUNTA DE DILATACION

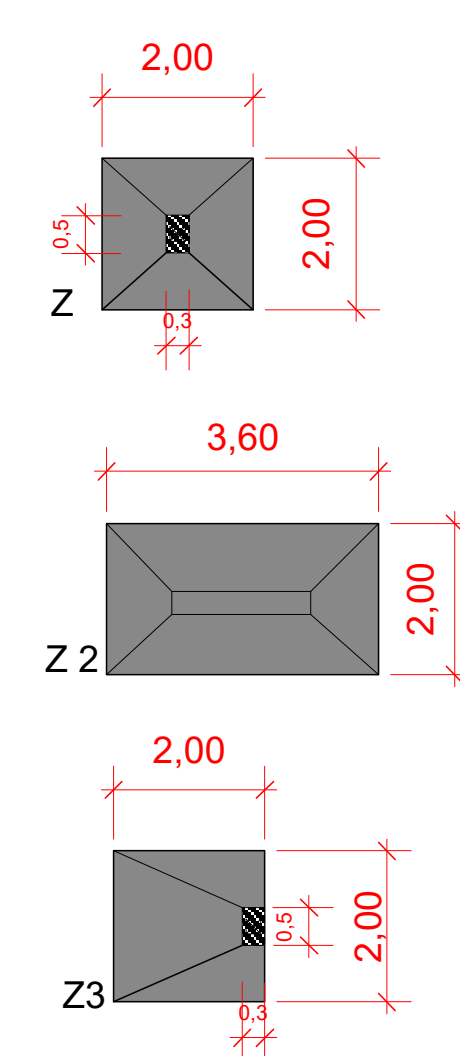
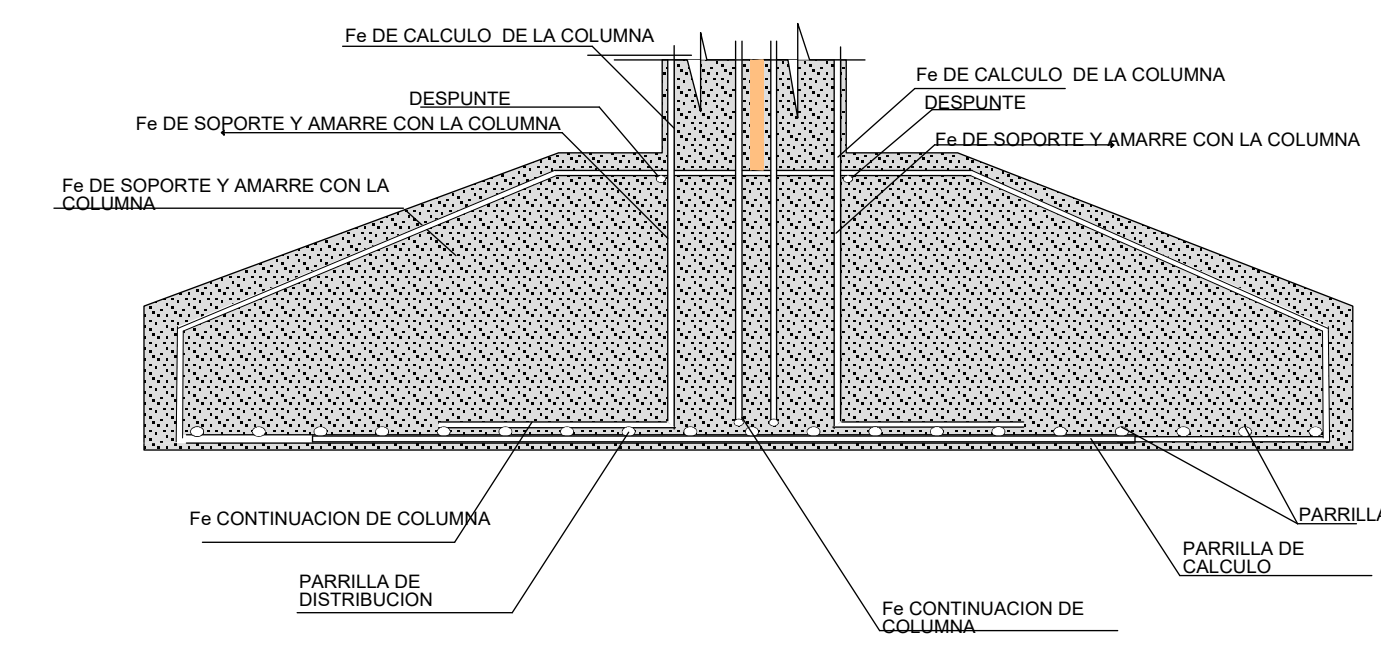

PLANO DE CIMIENTOS
ESC. 1:100

U.A.J.M.S. **PROYECTO DE GRADO**
 ARQUITECTURA Y URBANISMO
 DOCENTE: ARQ. BORDA VILLENA ALVARO FERNANDO
 UNIVERSITARIA: CLAUDIA EUGENIA TITO VIQUE
 GRUPO: 6

