

4.4.-INTALACIONES ELECTRICAS

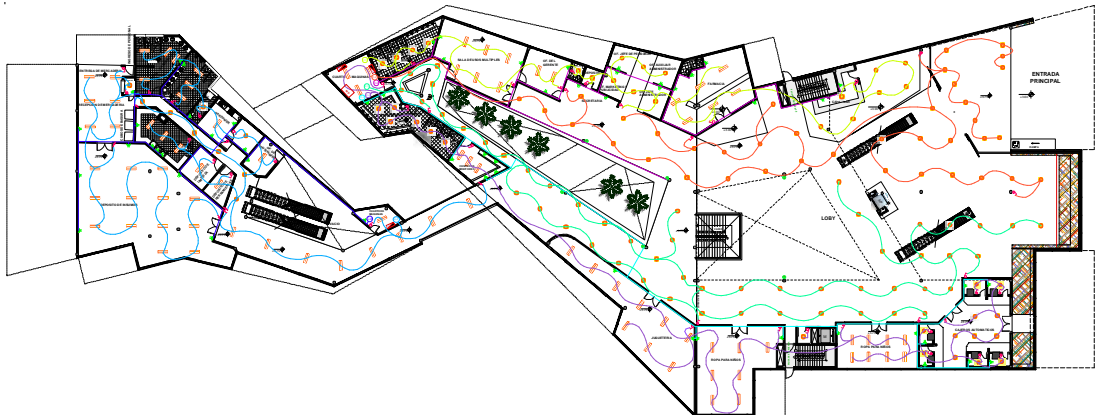

4.4.1.-PLANA BAJA

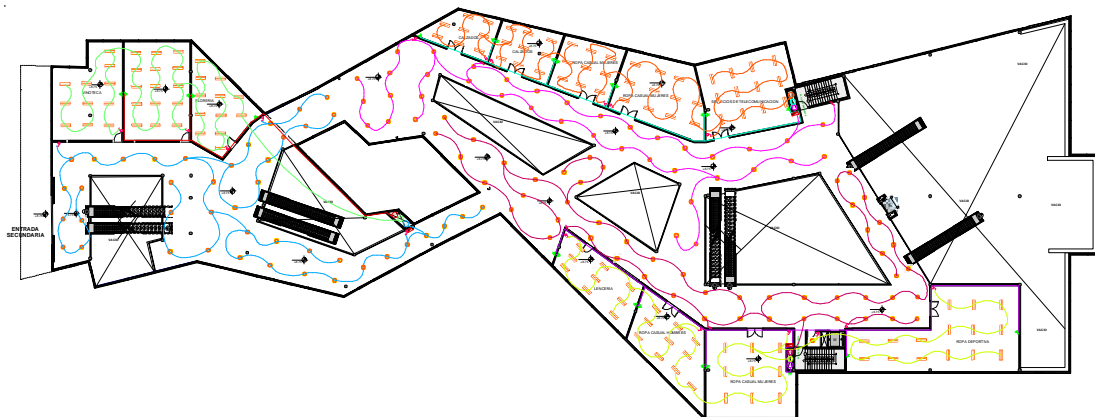

4.4.2.-PRIMERA PLANTA

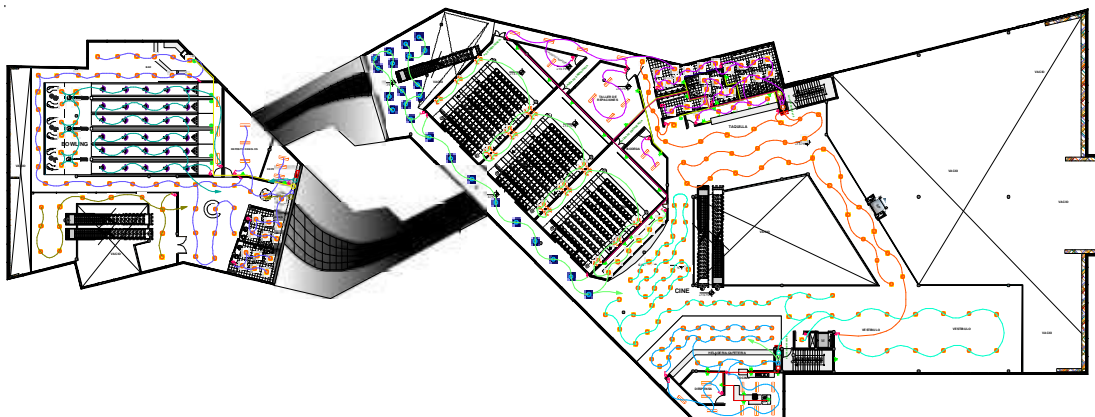

4.4.3.-SEGUNDA PLANTA

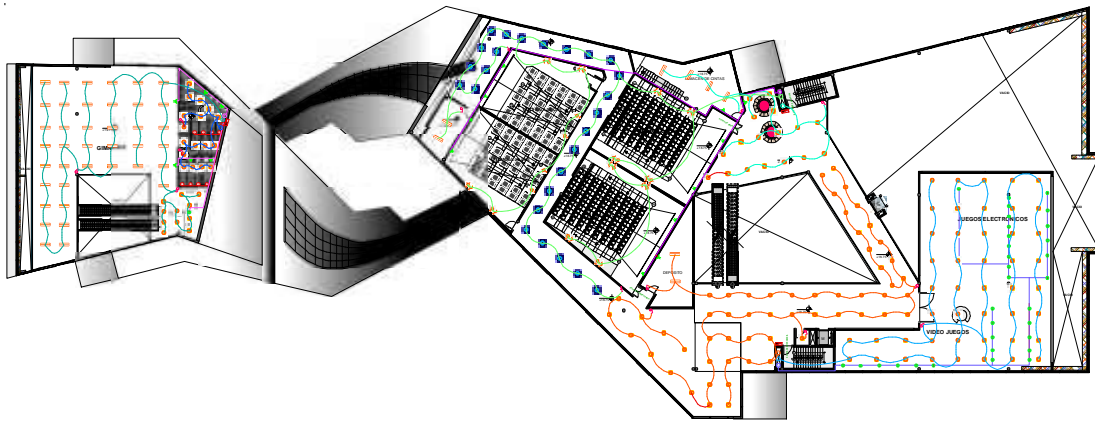

4.4.4.-TERCERA PLANTA

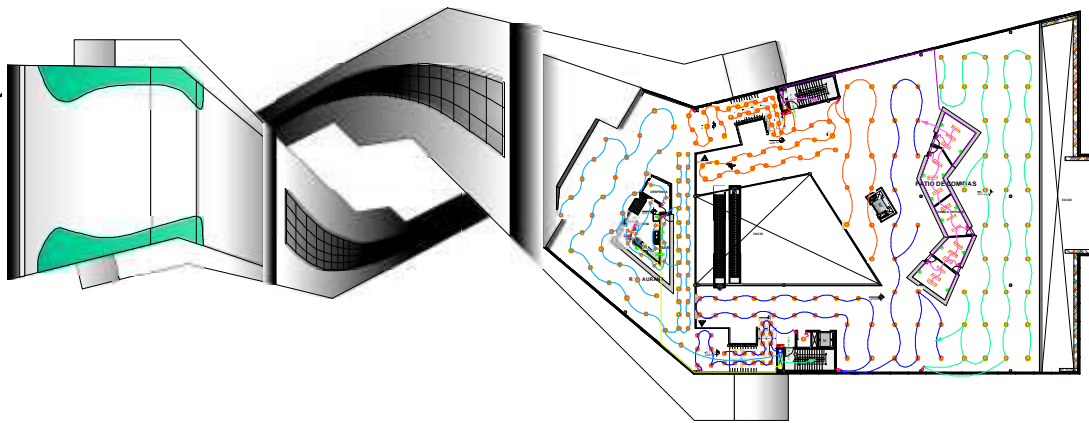

4.4.5.-CUARTA PLANTA

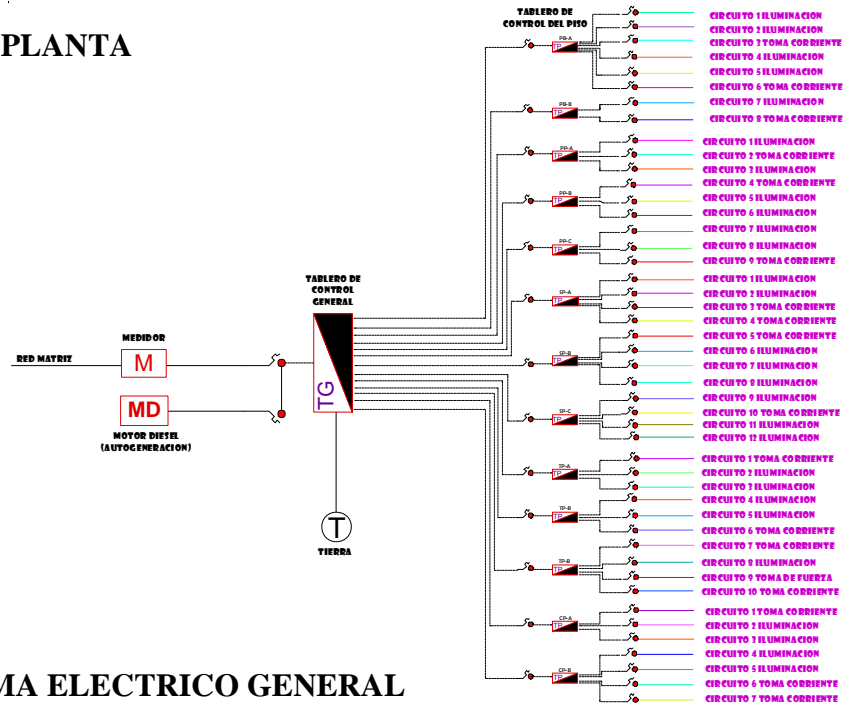

4.4.6.-DIAGRAMA ELECTRICO GENERAL

4.5.-INSTALACIONES SANITARIAS

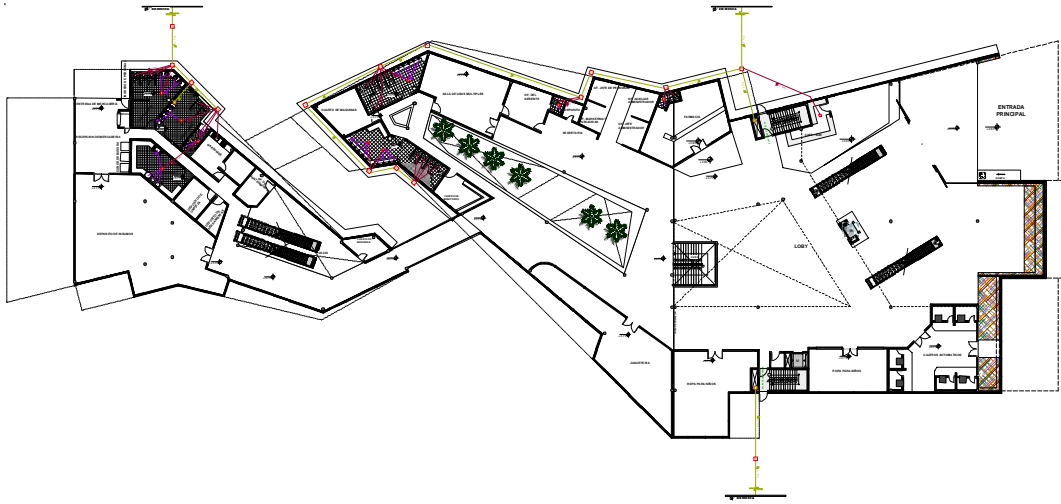

4.5.1.-PLANTA BAJA

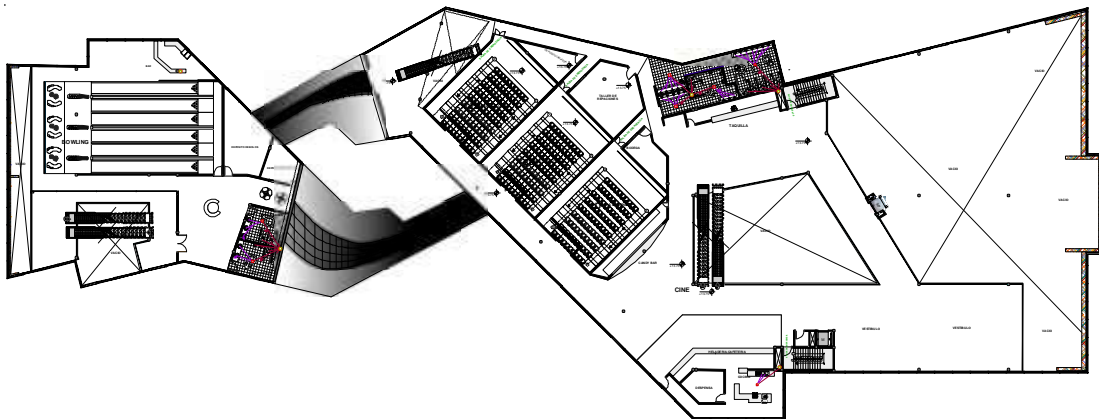

4.5.2.-SEGUNDA PLANTA

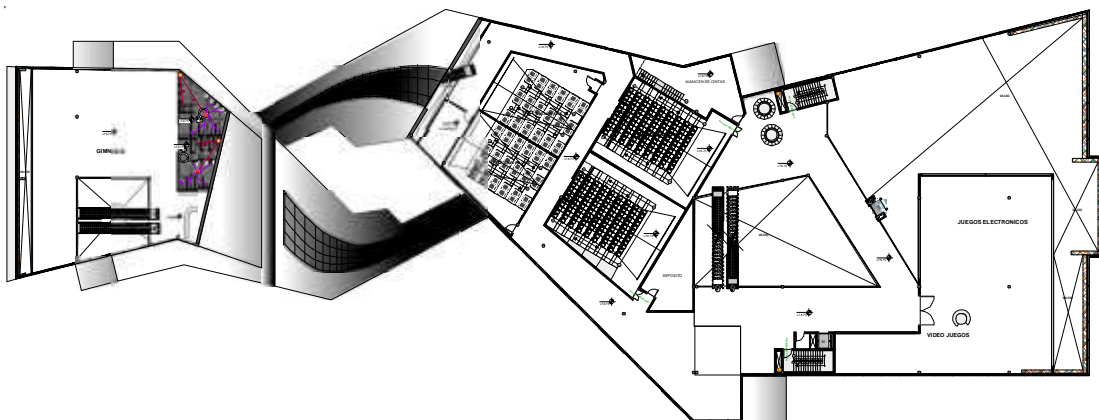

4.5.3.-TERCERA PLANTA

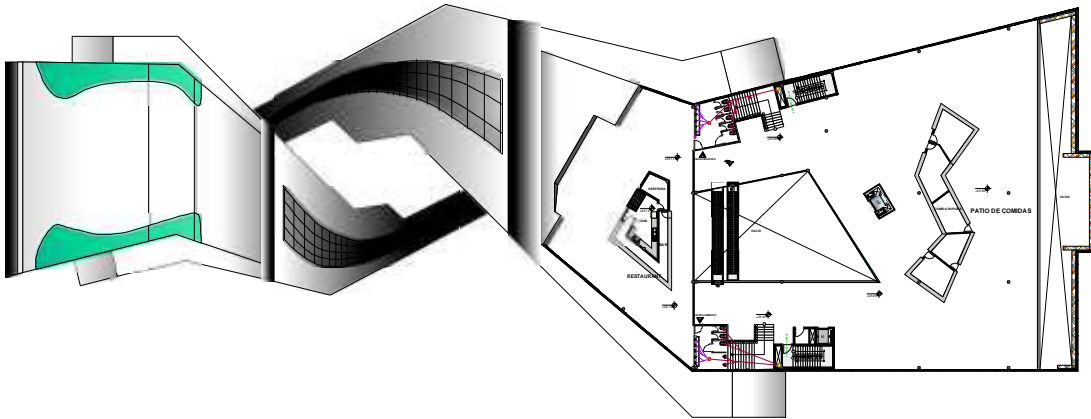

4.5.4.-CUARTA PLANTA

4.6.-INSTALACIONES CAMARA DE SEGURIDAD

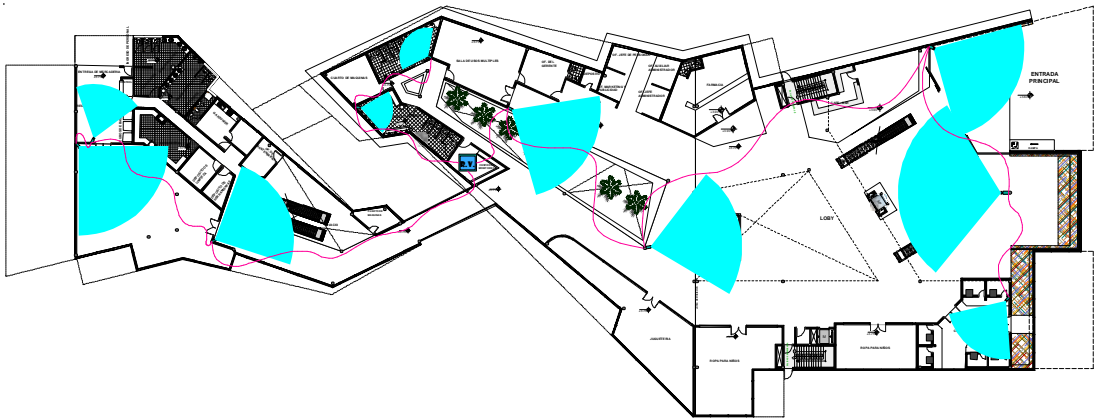

4.6.1.-PLANTA BAJA

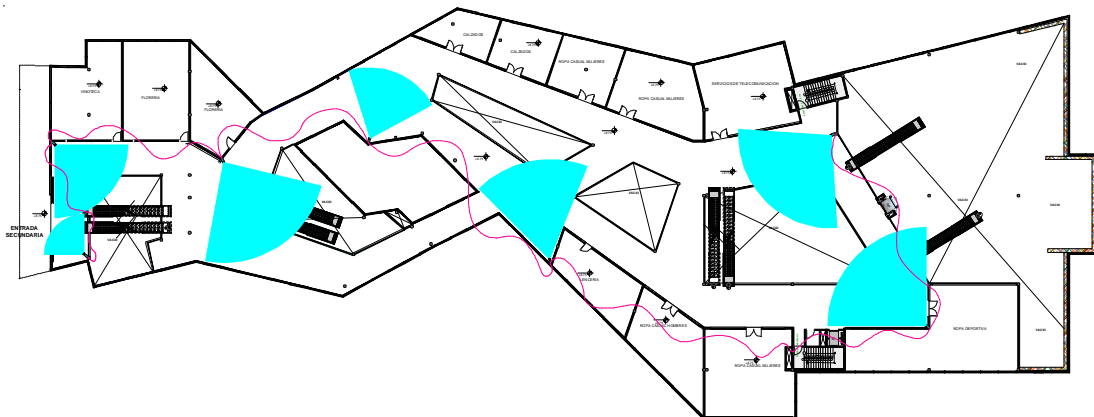

4.6.2.-PRIMERA PLANTA

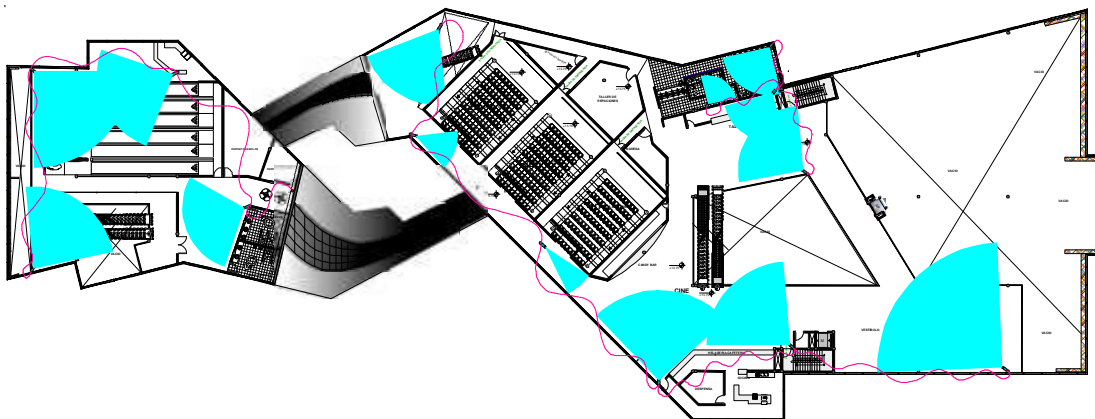

4.6.3.-SEGUNDA PLANTA

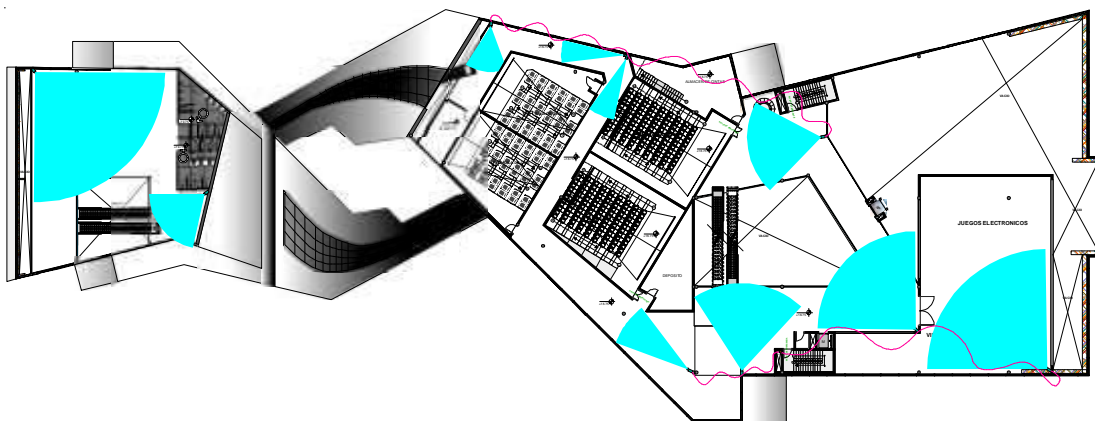

4.6.4.-TERCERA PLANTA

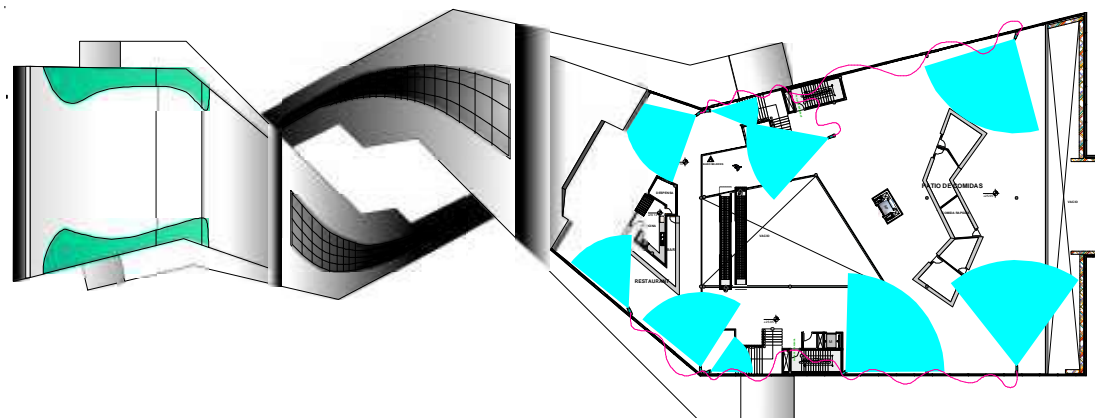

4.6.5.-CUARTA PLANTA

4.7.-DETALES CONSTRUCTIVOS

4.7.1.-MURO CORTINA ESTRUCTURAL

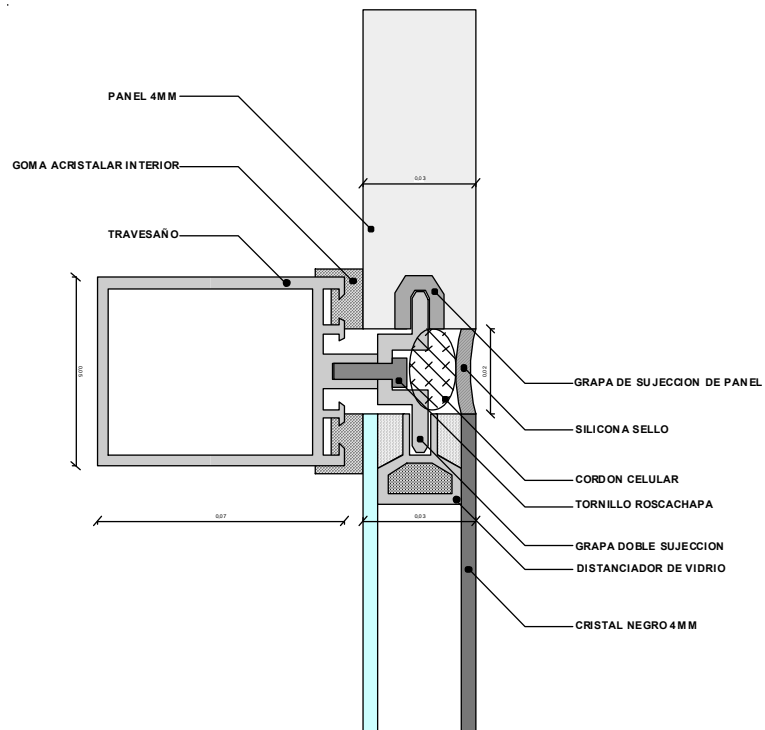
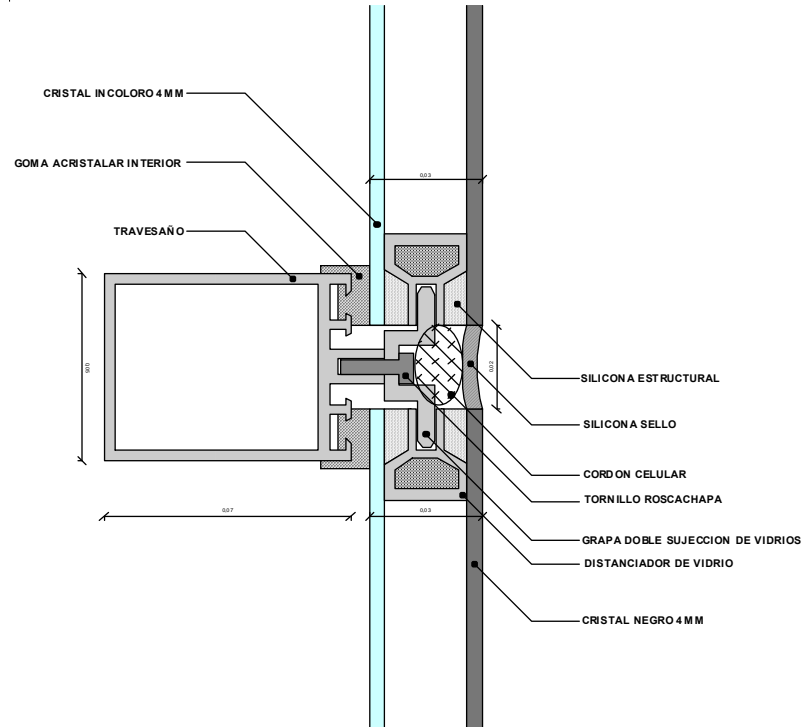

4.7.2.-CORTE DE BORDE

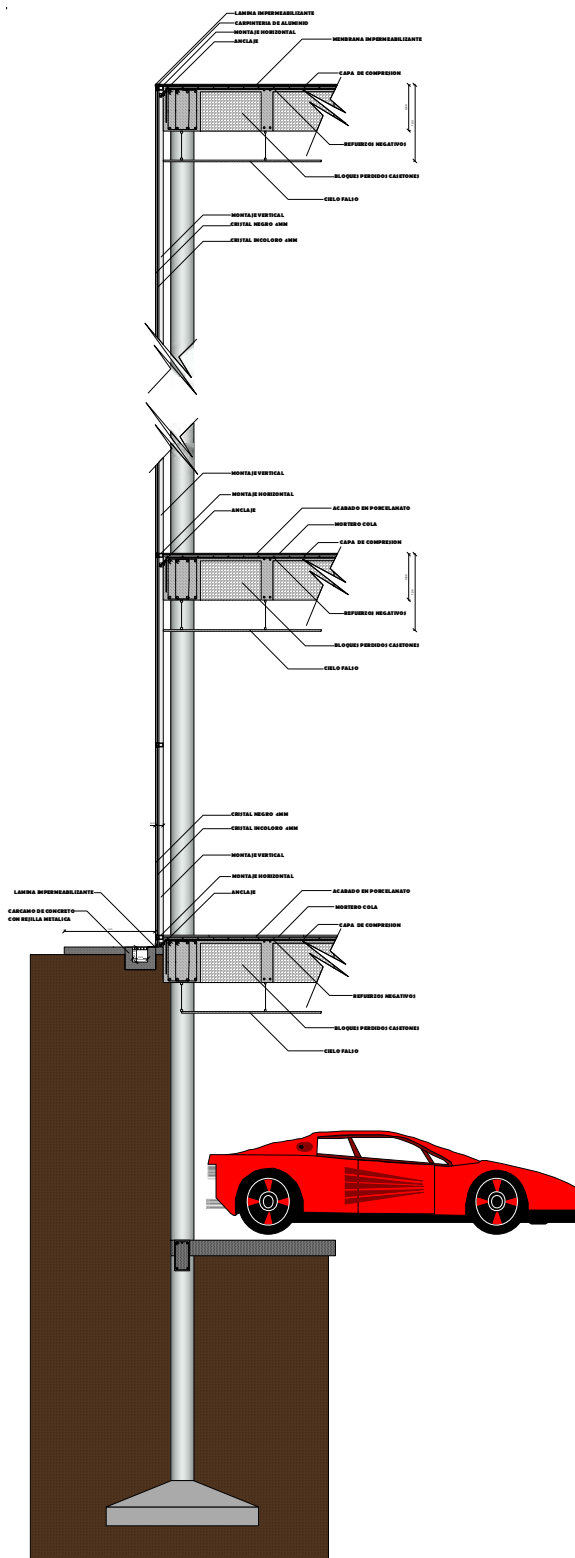

4.8.-PERSPECTIVAS



