



# Microsoft SQL Server 2016 Licensing Guide



# Contents

Overview	3
SQL Server 2016 Editions	4
How SQL Server 2016 License Are Sold Server and Cloud Enrolment	6
SQL Server 2016 Licensing Models Core-Based Licensing Server + CAL Licensing	8
Licensing SQL Server 2016 Components	12
Licensing SQL Server 2016 in a Virtualized Environment Licensing Individual Virtual Machines Licensing for Maximum Virtualization	13
Licensing SQL Server for the Analytics Platform System	17
Advanced Licensing Scenarios and Detailed Examples Licensing SQL Server for High Availability Licensing SQL Server for Application Mobility Licensing SQL Server in a Multiplexed Application Environment Licensing SQL Server for Non-Production Use	19
Additional Product Information SQL Server 2016 Migration Options for Software Assurance Customers Software Assurance Benefits Additional Product Licensing Resources	27

© 2016 Microsoft Corporation. All rights reserved.

This document is for informational purposes only. MICROSOFT MAKES NO WARRANTIES, EXPRESS OR IMPLIED, IN THIS SUMMARY.

Microsoft provides this material solely for informational and marketing purposes. Customers should refer to their agreements for a full understanding of their rights and obligations under Microsoft's Commercial Licensing programs. Microsoft software is licensed not sold. The value and benefit gained through use of Microsoft software and services may vary by customer. Customers with questions about differences between this material and the agreements should contact their reseller or Microsoft account manager. Microsoft does not set final prices or payment terms for licenses acquired through resellers. Final prices and payment terms are determined by agreement between the customer and its reseller. Eligibility for Software Assurance benefits varies by offering and region and is subject to change. The terms and conditions of your Commercial License Agreement and the terms and conditions under which any specific Software Assurance benefits are offered will take precedence in the case of any conflict with the information provided here. For eligibility criteria and current benefit program rules, see the Microsoft Product List.

# Overview

This Licensing Guide is for people who want to gain a basic understanding of how Microsoft® SQL Server® 2016 database software is licensed through Microsoft Commercial Licensing programs. This guide does not supersede or replace any of the legal documentation covering SQL Server 2016 use rights. Specific product license terms are defined in the product Software License Terms—or in the case of Microsoft Commercial Licensing—in the Microsoft Commercial Licensing agreement under which the software was acquired and/or the Microsoft Commercial Licensing Product Terms. This licensing guide is not a legal use rights document. Program specifications and business rules are subject to change.

# SQL Server 2016 Editions

SQL Server 2016 is offered in two main editions to accommodate the unique feature, performance, and price requirements of organizations and individuals:

- **Enterprise Edition** is ideal for mission-critical applications and large-scale data warehousing.
- **Standard Edition** delivers basic database, reporting, and analytics capabilities.

The editions are offered in a straightforward, tiered model that creates greater consistency across the product editions, features, and licensing. Enterprise Edition includes all the capabilities available in SQL Server 2016.

SQL Server 2016 Capabilities	SQL Server 2016 Editions	
	Standard	Enterprise
Licensing Options	Core-Based or Server+CAL	Core-Based
Windows Server Core Edition Support	•	•
Basic OLTP	•	•
Basic Reporting & Analytics	•	•
Programmability & Developer Tools (T-SQL, CLR, Data Types, FileTable, JSON)	•	•
Manageability (Management Studio, Policy-Based Management)	•	•
Basic Corporate Business Intelligence (Multi-dimensional models, Basic tabular model)	•	•
Advanced Corporate Business Intelligence (Advanced tabular model, Direct query, in-memory analytics, Mobile BI)		•
Enterprise Data Management (Data Quality Services, Master Data Services)		•
Advanced Security (Always Encrypted, Advanced Auditing, Transparent Data Encryption)		•
In-memory ColumnStore, In-memory OLTP		•
High Availability	Basic Availability Groups*	AlwaysOn Availability Groups

This table shows a comparison of key capabilities across the main SQL Server 2016 editions (\*Basic Availability Groups includes 2-node Failover Clustering).

Other specialty editions of SQL Server 2016 include Developer Edition, which is licensed for non-production use; the freely downloadable and distributable Express Edition; and the next-generation SQL Server Parallel Data Warehouse, which is available as a component of the Analytics Platform System integrated appliance offering. Note that starting with SQL 2016, the deployment option for SQL Server Parallel Data Warehouse is enabled through SQL Server Enterprise (covered later in this document).

With SQL Server 2016, the Web Edition remains available only under the Microsoft Services Provider License Agreement (SPLA).

- For general information on each of the SQL Server 2016 editions, visit <http://www.microsoft.com/en-us/server-cloud/products/sql-server-editions/>.
- For more information on the Analytics Platform System visit <https://www.microsoft.com/en-us/server-cloud/products/analytics-platform-system/>.
- For detailed product specifications and a full feature-by-feature comparison of the SQL Server 2016 editions, visit [https://msdn.microsoft.com/en-us/library/ms143287\(v=sql.130\).aspx](https://msdn.microsoft.com/en-us/library/ms143287(v=sql.130).aspx).

SQL Server 2016 Edition	Database Engine (DBE) Capacity Limits			Analysis Services (AS) and Reporting Services (RS) Capacity Limits		
	Max Compute Capacity	Max Memory Utilization - DBE	Max DB Size	Max Compute Capacity	Max Memory Utilization - AS	Max Memory Utilization - RS
Enterprise Per Core	OS max	OS max	524 PB	OS max	OS max	OS max
Enterprise Server+CAL	20 core limit	OS max	524 PB	20 core limit	OS max	OS max
Standard	Lesser of 4 sockets or 24 cores	128 GB	524 PB	Lesser of 4 sockets or 24 cores	64 GB (MOLAP) 16 GB (Tabular)	64 GB
Web	Lesser of 4 sockets or 16 cores	64 GB	524 PB	Lesser of 4 sockets or 16 cores	N/A	64 GB
Express	Lesser of 1 socket or 4 cores	1 GB	10 GB	Lesser of 1 socket or 4 cores	N/A	4 GB (Advanced Services Ed.)
Developer	OS max	OS max	OS max	OS max	OS max	OS max

This table shows a comparison of the key capacity limits across the SQL Server 2016 editions.

- For more information on the compute capacity limits for each edition of SQL Server 2016, visit [https://msdn.microsoft.com/en-us/library/ms143760\(v=sql.130\).aspx](https://msdn.microsoft.com/en-us/library/ms143760(v=sql.130).aspx).

# How SQL Server 2016 Licenses Are Sold

SQL Server 2016 software licenses are sold through channels designed to meet the unique needs of customers. These sales channels include online retailers offering full packaged product (FPP) licenses of SQL Server software, Original Equipment Manufacturers (OEMs) offering pre-installed licenses with their hardware systems, as well as Licensing Solutions Partners (LSPs) and Enterprise Software Advisors (ESAs) offering SQL Server software through Microsoft Commercial Licensing programs for end-customer organizations.

For customers with as few as five users, Microsoft offers licensing programs to help reduce administrative overhead and software management costs, while enabling product licensing on an ongoing basis at a considerable discount. The various licensing options enable customers to choose the program that works best for their management and operational needs.

- Comprehensive programs that offer Software Assurance as a fixed benefit include the Open Value (OV), Open Value Subscription (OVS), Enterprise Agreement (EA), Enterprise Subscription Agreement (EAS), and the Server and Cloud Enrollment (SCE).
- Transactional programs include Open and the Microsoft Products and Services Agreement (MPSA).

## Server and Cloud Enrollment

The Server and Cloud Enrollment (SCE) is an enrollment under the Microsoft Enterprise Agreement that enables highly committed customers to standardize broadly on one or more key server and cloud technologies from Microsoft. In exchange for making an installed-base-wide commitment to one or more components of the Server and Cloud Enrollment, customers receive the best pricing and terms, plus other benefits, including cloud-optimized licensing options and simplified license management.

Microsoft also offers programs that can meet the specific needs of organizations that partner with Microsoft to provide additional software and services, such as the Microsoft Independent Software Vendor (ISV) Royalty Licensing Program and the Microsoft Services Provider License Agreement (SPLA).

SQL Server 2016 Editions	Retail	Commercial Licensing Programs			Third Party	
	FPP/ESD	OPEN	MPSA	EA/EAS/SCE	ISVR	SPLA
Enterprise Edition		•	•	•	•	•
Standard Edition	•	•	•	•	•	•
Web Edition						•
Express Edition	Free download					
Developer Edition	Free download					

This table shows the primary channel availability for SQL Server 2016 software licenses. Not every edition is available in all channels or licensing programs in all regions.

- For more information about Microsoft Commercial Licensing Programs, [download the Commercial Licensing Reference Guide](#) (PDF, 2.1 MB).
- For details on the Microsoft Server and Cloud Enrollment, visit <http://www.microsoft.com/licensing/licensing-options/enterprise.aspx>.

# SQL Server 2016 Licensing Models

With SQL Server 2016, Microsoft offers a variety of licensing options aligned with how customers typically purchase specific workloads. The Server+CAL licensing model provides the option to license users and/or devices and then have low-cost access to incremental SQL Server deployments. For customers who cannot count users or require premium database capabilities, Microsoft licenses SQL Server in a core-based licensing model. Core-based licensing gives customers a more precise measure of computing power and a more consistent licensing metric, regardless of whether solutions are deployed on physical on-premises servers or in virtual or cloud environments.

SQL Server 2016 Editions	Description	Licensing Options		
		Server+CAL	Per Core	Requirements
Enterprise	For mission-critical applications and large-scale data warehousing		•	
Standard	Basic database, reporting, and analytics capabilities	•	•	SQL Server CALs required when licensing Server+CAL

This table compares the licensing options for each of the main SQL Server 2016 editions.

## Core-Based Licensing

Under the Per Core licensing model, **each server** running SQL Server 2016 software or any of its components (such as Reporting Services or Integration Services) must be assigned an appropriate number of SQL Server 2016 core licenses. The number of core licenses needed depends on whether customers are licensing the physical server or individual virtual operating system environments (OSEs).

Unlike the Server+CAL licensing model, the Per Core model allows access for an unlimited number of users or devices to connect from either inside or outside an organization's firewall. With the Per Core model, customers do not need to purchase additional client access licenses (CALs) to access the SQL Server software.



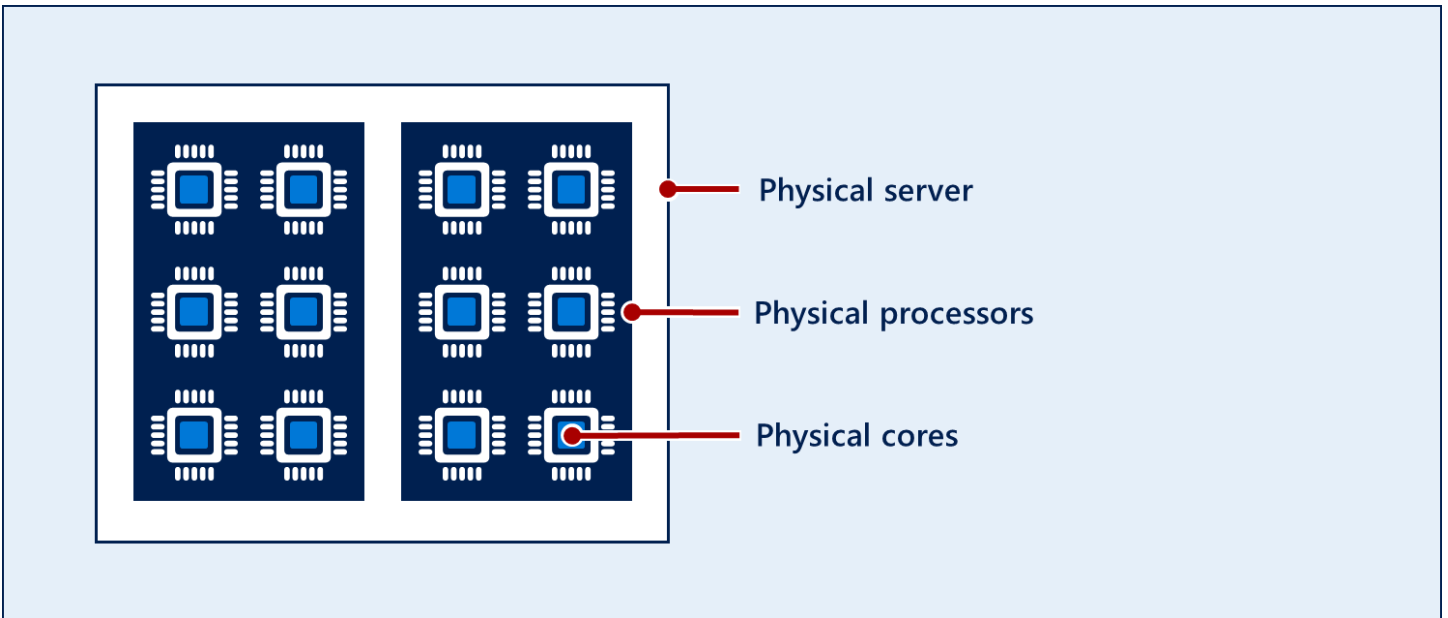

This figure depicts a physical server with two physical processors, each containing six physical cores.

Physical Server	A <b>server</b> is a physical hardware system capable of running server software. A hardware partition or blade is considered to be a separate physical hardware system.
Physical Processor	A <b>processor</b> is generally a physical chip that resides in a physical socket of the hardware partition and contains one or more cores.
Physical Core	Each physical processor contains smaller processing units called <b>physical cores</b> . Some processors have two cores, some four, some six or eight, and so on. The figure above shows an example of two physical processors with six cores each.
Hardware Thread	A <b>hardware thread</b> is either a physical core or a hyper-thread in a physical processor.
Physical Operating System Environment	A physical operating system environment (OSE) is configured to run directly on a physical hardware system and is all or part of an operating system instance.

For detailed definitions of these and other key licensing terms, please refer to the Microsoft Commercial Licensing Product Terms.

## How to License SQL Server 2016 Using the Per Core Licensing Model

When running SQL Server in a **physical OSE**, all physical cores on the server must be licensed. Software partitioning does not reduce the number of core licenses required, except when licensing individual virtual machines (VMs). **A minimum of four core licenses are required for each physical processor on the server.**

To determine and acquire the correct number of core licenses needed, customers must:

- 1 Count the total number of physical cores in the server.
- 2 Purchase the appropriate number of core licenses required for the server. Core licenses are sold in packs of two, so customers must divide the number of licenses required by two to determine the actual number of line items (licensing SKUs) to order.

➤ For more details on the Per Core licensing model, including key terms and licensing definitions, download the [Introduction to Per Core Licensing Commercial Licensing Brief](#).

## The Per Core licensing model is appropriate when:

- Deploying the SQL Server 2016 Enterprise Edition (including using the SQL Server Parallel Data Warehouse deployment option) or SQL Server 2016 Web Edition software.
- Deploying Internet or extranet workloads or deploying systems that integrate with external-facing workloads (even if external data goes through one or more other systems), or when the number of users/devices cannot be counted easily.
- Implementing centralized deployments that span a large number of direct and/or indirect users/devices.
- The total licensing costs for licensing SQL Server 2016 Standard Edition software are lower than those incurred using the Server+CAL licensing model.

**Note:** The use of hyper-threading technology does not affect the number of core licenses required when running SQL Server software in a physical OSE.

For details on how to license virtual OSEs using the Per Core model, refer to the [Licensing SQL Server 2016 in a Virtual Environment](#) section of this guide.

## Server + CAL Licensing

When licensing the SQL Server 2016 Standard Edition software under the Server+CAL model, customers purchase a server license for each server and a client access license (CAL) for each device (Device CAL) and/or user (User CAL) accessing SQL Server or any of its components. A CAL is not software; it is a license granting users and devices access to the SQL Server software.

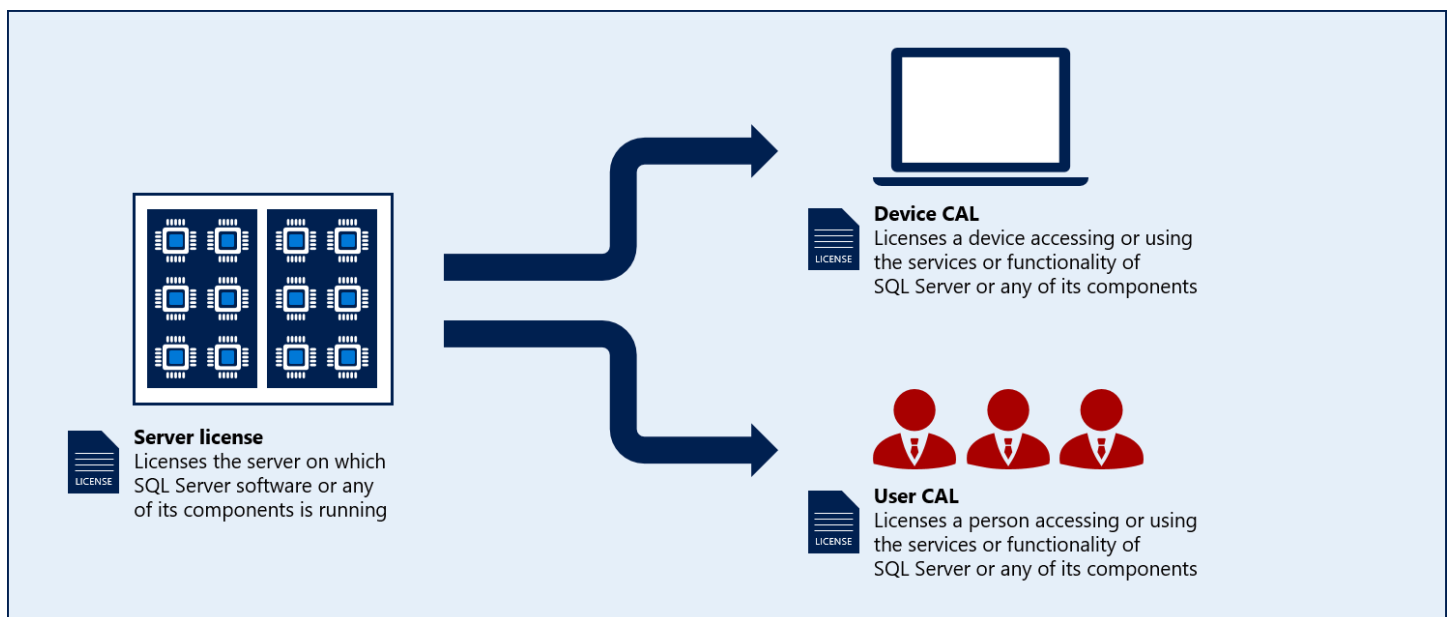

This figure illustrates the licenses used in the Server+CAL licensing model.

## How to License SQL Server 2016 Using the Server+CAL Licensing Model

Under the Server+CAL licensing model, each operating system environment (OSE) running SQL Server 2016 software or any of its components must have a SQL Server 2016 server license assigned to the physical server hosting the OSE. Each server license allows customers to run any number of SQL Server instances in a single OSE, either physical or virtual.

**Note:** Running SQL Server software on different hardware partitions or blades requires separate software licenses. Hardware partitions and blades are considered to be separate servers for licensing purposes and SQL Server software licenses cannot be assigned to more than one server at any time.

To access a licensed SQL Server, each user or device must have a SQL Server CAL that is the same version or newer than the SQL Server software version being accessed. For example, to access a server running SQL Server 2016 software, a user needs a SQL Server 2016 CAL.

**Note:** Devices not operated by humans require device CALs, even when connecting to SQL Server indirectly. For human-operated devices such as PCs or hand-held terminals, a user CAL or device CAL can be used.

While being version-specific, each SQL Server 2016 CAL provides access to any number of current and/or prior version licensed SQL Server instances in a customer's organization, current or previous product edition, including legacy SQL Business Intelligence, SQL Server Enterprise, SQL Server Workgroup, and SQL Server for Small Business edition servers.

**Note:** The use of hardware or software that reduces the number of devices or users that directly access or use the software (multiplexing/pooling) does not reduce the number of CALs required. For details on how to license SQL Server in a multiplexed application environment, refer to the [Advanced Licensing Scenarios](#) section of this guide.

**The Server+CAL licensing model is appropriate when:**

- Deploying SQL Server 2016 Standard Edition software in scenarios in which customers can easily count users/devices and the total licensing costs are lower than using the Per Core licensing model.
- Accessing multiple SQL Server databases and/or planning to scale out the use of SQL Server by adding new Standard Edition servers over time. After customers have purchased the necessary CALs, additional server licenses are needed only for new server system deployments.
- Accessing legacy Enterprise or Business Intelligence edition servers in the Server+CAL licensing model. For more detailed information on this topic, refer to the [Additional Product Information](#) section of this guide.

# Licensing SQL Server 2016 Components

SQL Server software includes a range of licensed server components, including but not limited to the SQL Server Database Engine (DB), SQL Server R Services for Windows, Master Data Services (MDS), Analysis Services (AS), Integration Services (IS), Reporting Services (RS), and Data Quality Services (DQS). In addition, a number of management components, such as client applications and tools used for creating or working with analytical data, are provided.

➔ For more details on the software components specifically included with SQL Server 2016, visit [https://msdn.microsoft.com/en-us/library/ms144275\(v=sql.130\).aspx](https://msdn.microsoft.com/en-us/library/ms144275(v=sql.130).aspx).

The software components of a single SQL Server 2016 license cannot be separated. Any OSE running any of the licensed components of SQL Server 2016 requires a license. For example, if the SQL Server DB is deployed in one OSE and SQL Server RS is deployed in another, both OSEs must be fully licensed for SQL Server 2016 accordingly.

Management tools and other software identified as additional or supplemental software—such as product documentation, client connectivity tools, software add-ins, and Software Development Kits (SDKs)—can generally be distributed and run on any number of devices for use with a licensed instance of SQL Server software. Refer to the Commercial Licensing Product Terms for the list of additional software components provided with SQL Server 2016.

# Licensing SQL Server 2016 in a Virtualized Environment

Microsoft SQL Server is increasingly being deployed in virtualized environments, which enable running instances of SQL Server concurrently in separate virtual OSEs (or virtual machines).

SQL Server 2016 offers expanded virtualization rights, options, and benefits to provide greater flexibility for customers who are deploying in virtual environments. When deploying SQL Server 2016 software in virtualized environments, customers have the choice to license either individual virtual machines as needed or to license for maximum virtualization in highly virtualized, private cloud, or dynamic environments. Maximum virtualization can be achieved by licensing the entire physical server with Enterprise Edition core licenses and covering those licenses with Software Assurance.

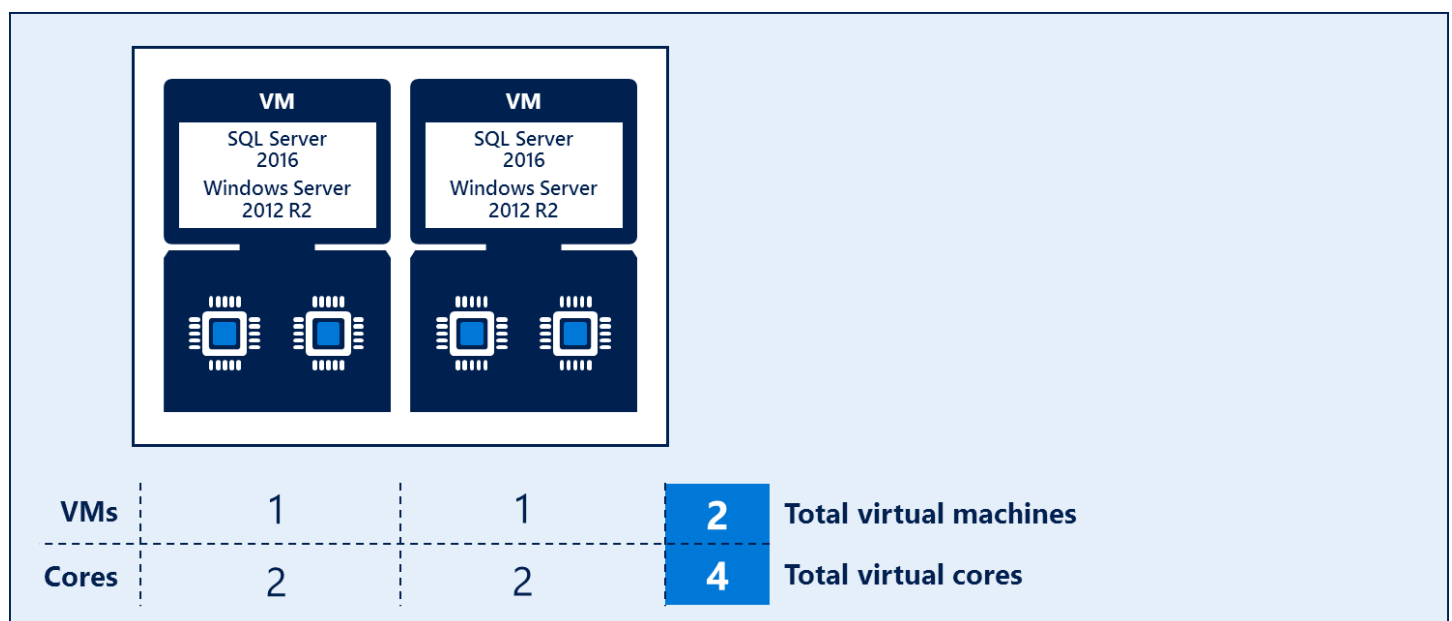

This figure depicts two virtual machines, each containing two virtual cores.

# Licensing Individual Virtual Machines

As customers consolidate existing workloads and refresh hardware, they may find that a SQL Server instance uses only a fraction of available system computing power. When deploying databases in virtual environments that require just a fraction of a physical server, savings can be achieved by licensing individual virtual machines (VMs).

## How to License Individual Virtual Machines Using the Per Core Licensing Model

Similar to the Per Core licensing model in physical OSEs, all virtual cores (v-cores) supporting virtual OSEs that are running instances of SQL Server 2016 software must be licensed accordingly.

To license individual VMs using the Per Core model, customers must purchase a core license for each v-core (or virtual processor, virtual CPU, virtual thread) allocated to the VM, subject to a four core license minimum per VM. For licensing purposes, a v-core maps to a hardware thread.

**Note:** Licensing individual VMs is the only licensing option available for SQL Server 2016 Standard Edition customers who are running the software in a virtualized environment under the Per Core model.

For customers with highly virtualized environments who want to move VMs dynamically across servers to reallocate resources as needed, Microsoft permits License Mobility as an exclusive Software Assurance benefit available for all SQL Server editions. For more information on licensing for application mobility, refer to the [Advanced Licensing Scenarios](#) section of this guide.

- 1 License the virtual cores in each virtual machine
- 2 A minimum of four core licenses is required for each virtual machine

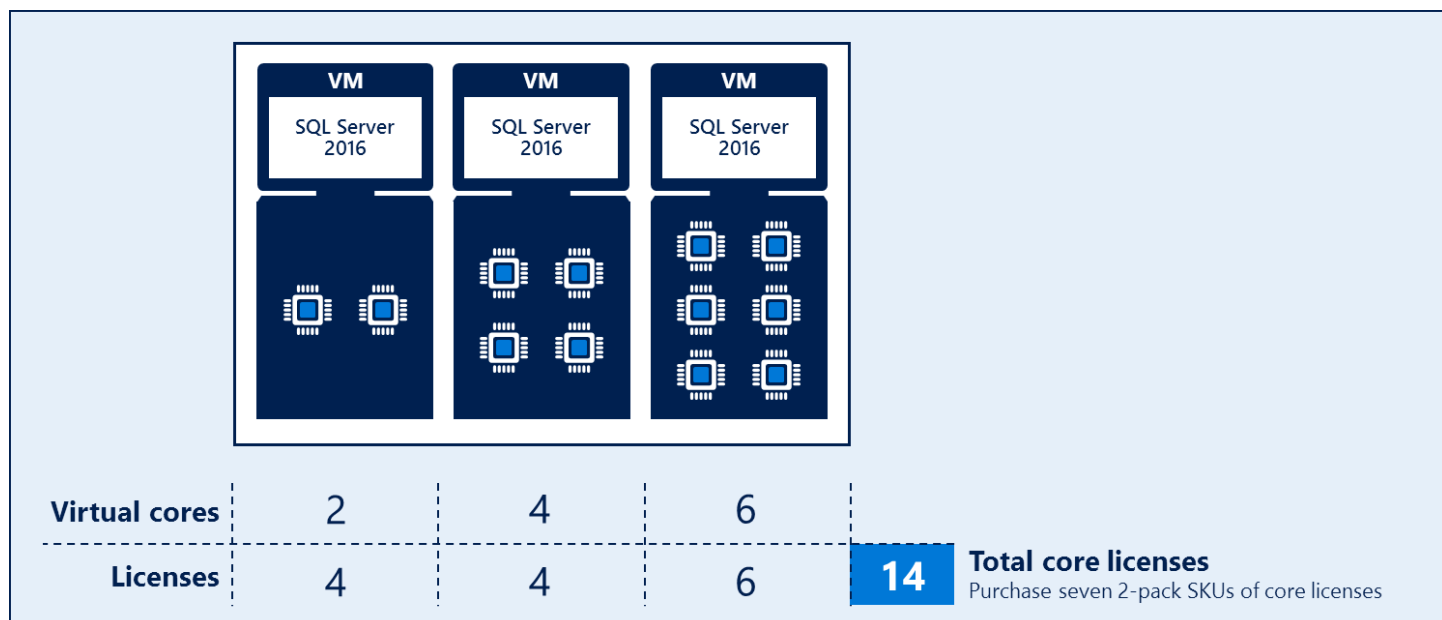

This figure illustrates the licensing requirements for three different virtual machines under the Per Core licensing model.

### Additional licenses are required when:

- A single hardware thread is supporting multiple virtual cores. (A core license is required for each v-core.)
- Multiple hardware threads are supporting a single virtual core simultaneously. (A core license allows a single v-core to be supported by a single hardware thread.)

### How to License Individual Virtual Machines Using the Server+CAL Licensing Model

To license individual VMs using the Server+CAL model, customers simply purchase one server license for each VM running SQL Server software, regardless of the number of virtual processors allocated to the VM.

For example, a customer who wants to deploy Standard Edition running in six VMs, each allocated with four v-cores, would need to assign six SQL Server 2016 Standard server licenses to that server.

**Note:** Each user or device accessing SQL Server 2016 software, regardless of a virtual or physical deployment, requires a SQL Server 2016 CAL.

For details on how to license individual VMs with legacy SQL Server Enterprise Edition server licenses, refer to the [Additional Product Information](#) section of this guide.

- 1 License each virtual machine with a server license
- 2 License each user or device with a CAL

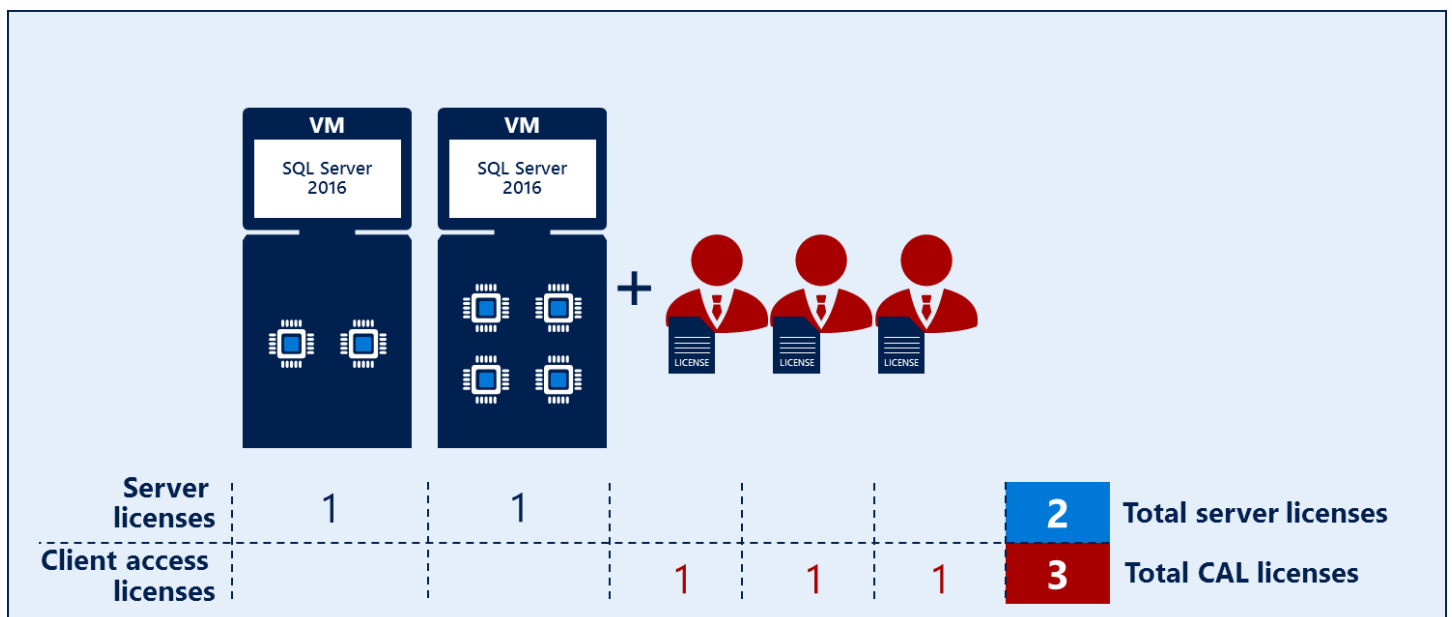

This figure shows an example of licensing virtual machines under the Server+CAL licensing model.

## Licensing for Maximum Virtualization

With SQL Server 2016 Enterprise Edition, customers who have **licensed all physical cores on the server** can run an unlimited number of instances of the software in a number of OSEs (physical and/or virtual) equal to the



number of core licenses assigned to the server. For example, a four-processor server with four cores per processor—fully licensed with 16 core licenses—can run SQL Server software in up to 16 VMs, regardless of the number of virtual cores allocated to each VM.

- Customers who have licensed all the physical cores on the server and want to run SQL Server 2016 software in more VMs than are permitted can assign additional core licenses to the licensed server.
- Each additional core license allows deployment of SQL Server software in an additional VM, so in the previous example, a customer who wants to run SQL Server Enterprise Edition in 18 VMs would simply acquire and assign 18 core licenses to that server.

With the addition of Software Assurance coverage on all Enterprise Edition core licenses (for a fully licensed server), customers’ use rights are expanded to allow any number of instances of the software to run in any number of OSEs (physical or virtual). This valuable Software Assurance benefit enables customers to deploy an unlimited number of VMs to handle dynamic workloads and fully utilize hardware computing capacity.

**Note:** This benefit ends when Software Assurance coverage expires.

Licensing for maximum virtualization can be an ideal solution when:

- Deploying SQL Server private cloud scenarios with high VM density.
- Hyper-threading is being used.
- Using dynamic provisioning and de-provisioning of VM resources.

- 1 Fully license the server with SQL Server 2016 Enterprise Edition core licenses and Software Assurance
- 2 Deploy an unlimited number of virtual machines

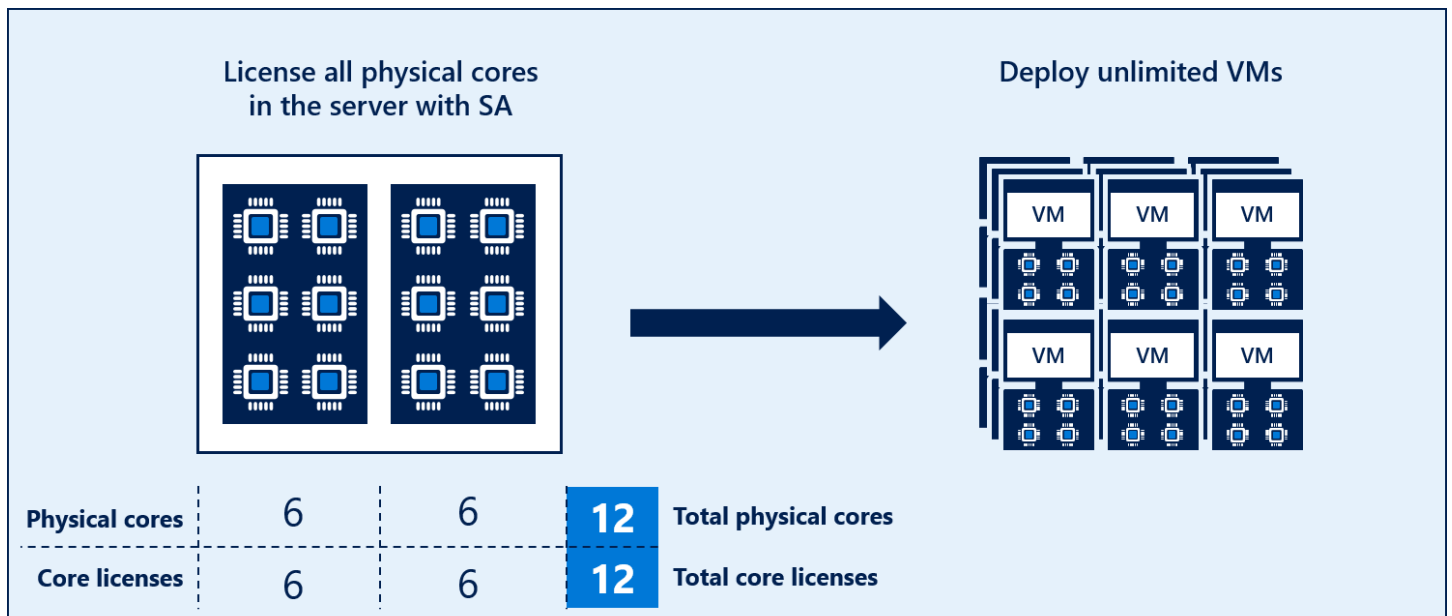

An example of licensing for unlimited VMs with Enterprise Edition core licenses and Software Assurance.

➤ For additional details on licensing SQL Server in virtualized environments, download the [SQL Server Virtualization Licensing Guide](#) (PDF, 2.7 MB).

# Licensing SQL Server for the Analytics Platform System

SQL Server Parallel Data Warehouse (PDW) is a specialized edition of SQL Server software that is available only as a component of the Analytics Platform System (APS) appliance. APS appliances provide data warehouse solutions that are offered only through preferred hardware partners.

Simple to deploy, SQL Server PDW is delivered as a component of a pre-built APS appliance with software, hardware, and networking components already pre-installed and configured to maximize data warehouse performance. Designed to grow with a customer's data warehousing needs, APS appliances can scale from a quarter rack configuration to a multiple rack solution supporting petabytes of data.

Beginning with SQL Server 2016, deploying and running SQL Server PDW is done through SQL Enterprise Edition Per Core licensing with SA coverage. The number of SQL Server Enterprise Edition core licenses for an APS appliance will depend on the total number of physical cores in the SQL Server PDW **compute servers** configured within the appliance.

**Note:** An APS appliance is defined to be a single unit made up of two or more active compute servers (also called compute nodes) that are controlled by a single PDW control VM (virtual OSE).

When licensing an APS appliance, all physical cores on all active SQL Server PDW compute servers must be fully licensed to run the SQL Server PDW software. For example, a quarter rack appliance configured with two active SQL Server PDW compute servers—each with two 8-core processors—would require a total of 32 SQL Server Enterprise Edition core licenses.

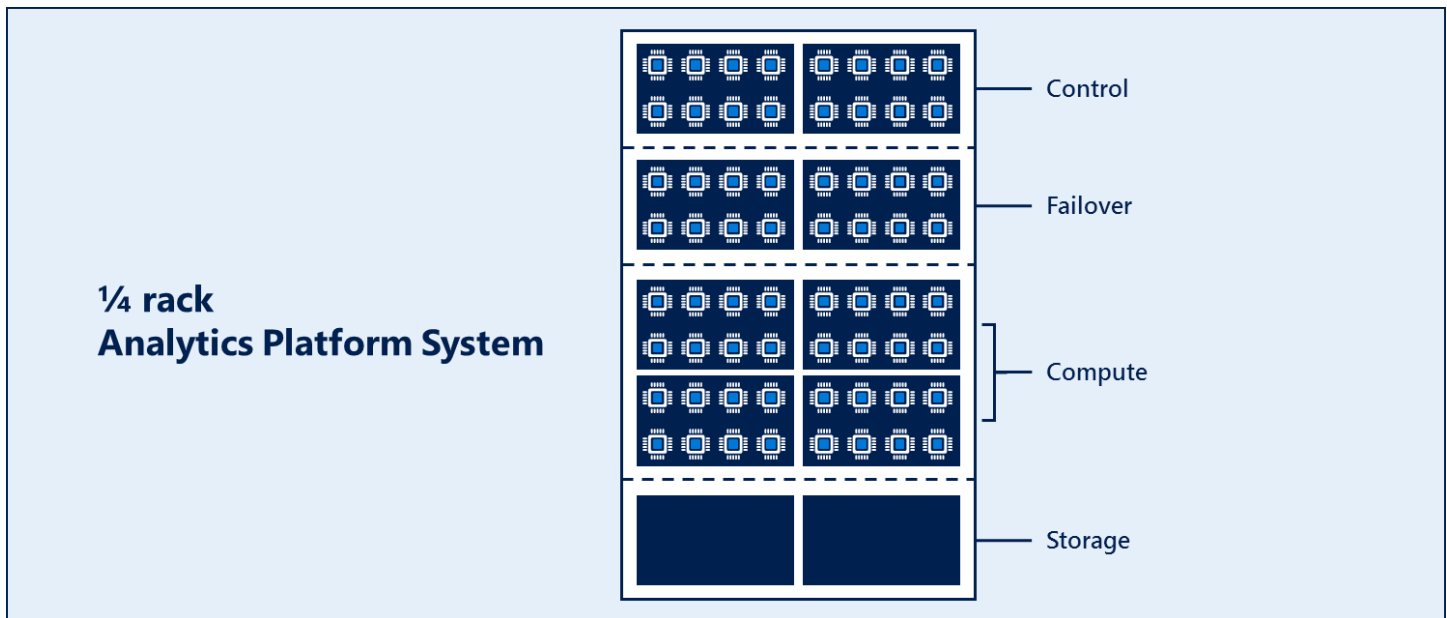

This figure depicts the architecture of a representative quarter rack APS appliance.

### Additional Considerations when Licensing APS Appliances:

- The underlying Windows Server Standard Edition software is acquired with the appliance hardware through an OEM license. Software Assurance coverage for Windows Server Standard Edition must be added through an applicable Microsoft Commercial Licensing program.
  - Windows Server CALs with Software Assurance are also required for all users accessing the APS appliance.
- Customers must additionally acquire software licenses with Software Assurance coverage for the SQL Server Enterprise and requisite System Center Standard software components through a Commercial Licensing program.
- Although SQL Server Enterprise core licenses are required only for the active compute nodes in an appliance, all servers—including the control server and passive failover servers configured in the appliance—must be fully licensed for both Windows Server Standard and System Center Standard Edition software.
- Licensing by individual OSE is not applicable to SQL Server PDW software deployments. As noted above, all physical cores on all active compute servers in the APS appliance running SQL Server PDW must be fully licensed for SQL Server Enterprise Edition.
- SQL Server software running on the PDW appliance control server is considered Additional Server Software and does not need to be separately licensed when all active compute servers are fully licensed as defined above.

# Advanced Licensing Scenarios and Detailed Examples

This section introduces a few advanced SQL Server 2016 licensing scenarios to help illustrate how customers can apply some of the key licensing principles covered in this guide. For detailed licensing terms and additional licensing guidance applicable to more specific software deployment scenarios, refer to the Microsoft Product Terms.

## Licensing SQL Server for High Availability

SQL Server software can be configured so that if one server fails, its processing will be picked up, recovered, and continued by another server. All editions of SQL Server 2016 provide basic high-availability features, including backup log shipping, database mirroring, and/or two-node failover clustering. Advanced (AlwaysOn) high-availability features in SQL Server 2016 Enterprise Edition include enhanced support for multiple, active (readable) secondary servers and support for multi-site failover clustering.

Log shipping and database mirroring take place at the database level, whereas failover clustering takes place at the SQL Server instance level.

### Failover Basics

For each server licensed with SQL Server 2016 and covered by active Software Assurance, customers can run up to the same number of passive failover instances in a separate OSE to support failover events. **A passive SQL Server instance is one that is not serving SQL Server data to clients or running active SQL Server workloads.** The passive failover instances can run on a separate server. These may be used only to synchronize with the primary server and otherwise maintain the passive database instance in a warm standby state in order to minimize downtime due to hardware or software failure.

- The secondary server used for failover support does not need to be separately licensed for SQL Server as long as it is truly passive and the primary SQL Server is covered with active Software Assurance. If it is serving data, such as reports to clients running active SQL Server workloads, or performing any “work”, such as additional backups being made from secondary servers, then it must be licensed for SQL Server.

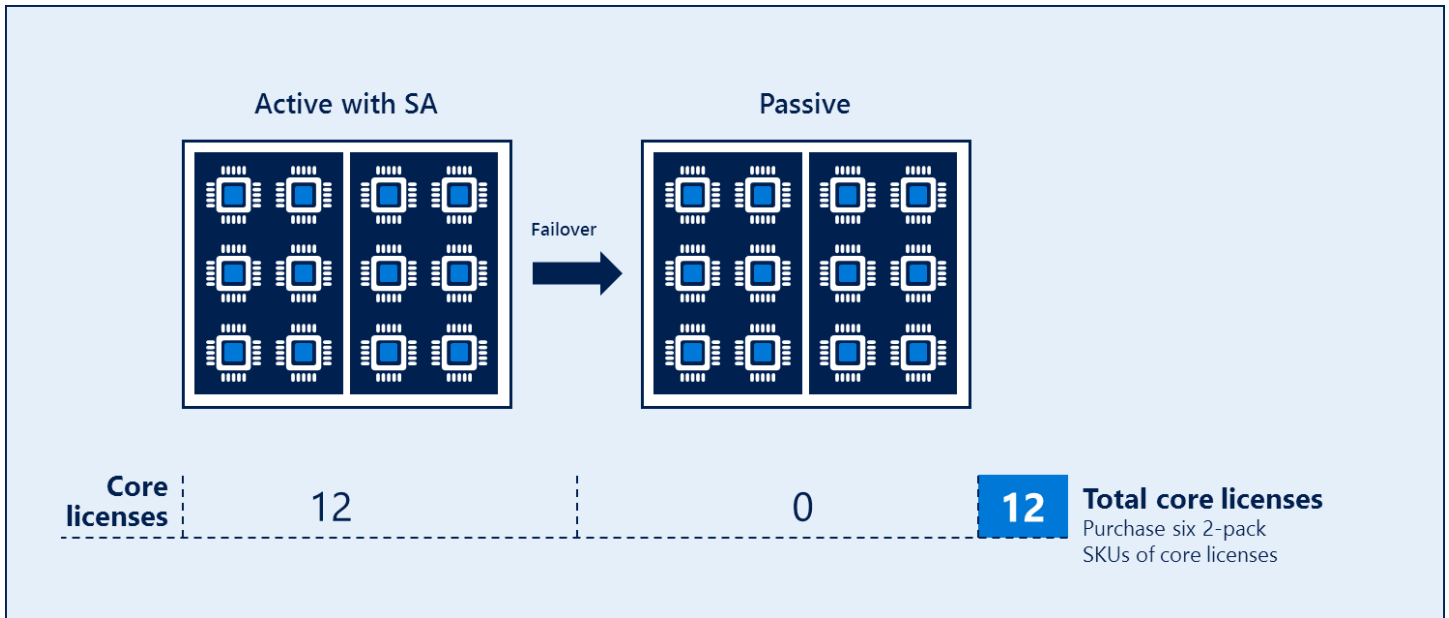

This figure shows an example of licensing an active primary SQL Server 2016 database with Software Assurance and a passive secondary database hosted on-premises.

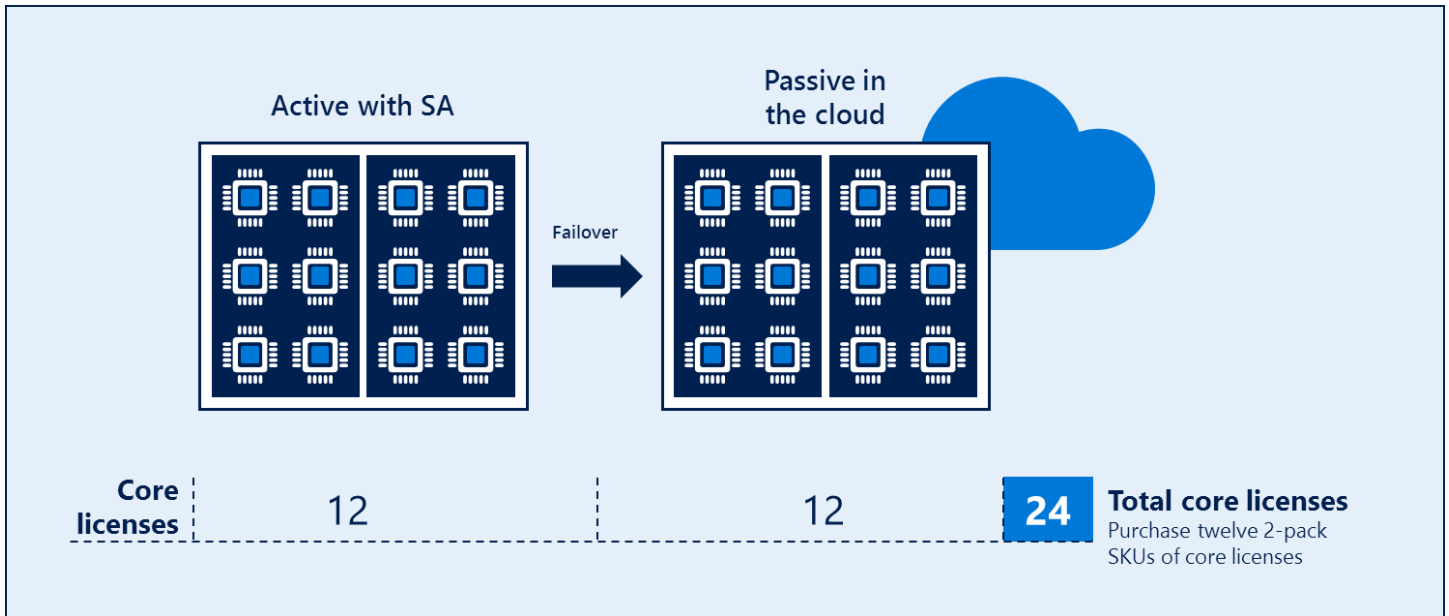

This figure shows an example of licensing an active primary SQL Server 2016 database with Software Assurance and a passive secondary database hosted in the cloud.

- If you are using License Mobility to license your primary database running on shared hardware in the cloud, you may run the same number of passive SQL Server instances in a separate OSE running in the cloud on shared hardware to support failover events

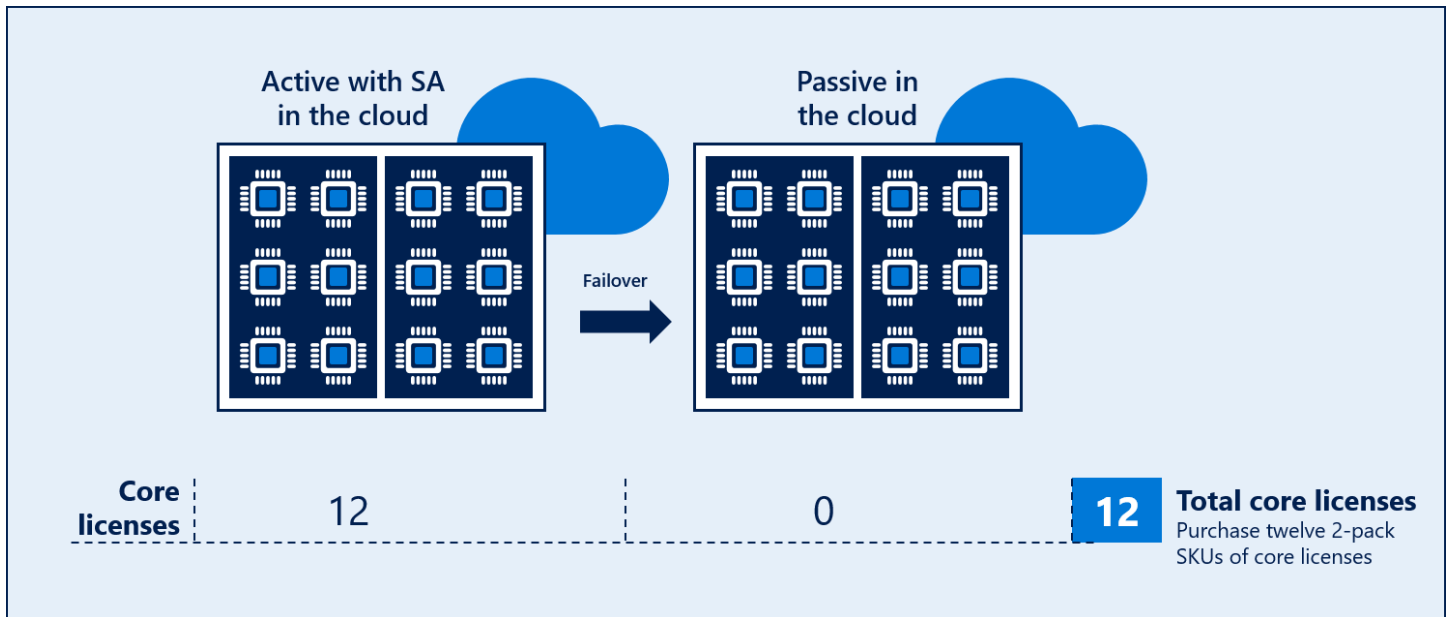

This figure shows an example of licensing both the active primary SQL Server 2016 database with Software Assurance and a passive secondary database in the cloud.

- Primary server licenses covered with Software Assurance include support for one secondary server only; any additional secondary servers must be licensed for SQL Server. Note: The rights to run a passive instance of SQL Server for failover support are not transferable to other licensed servers for purposes of providing multiple passive secondary servers to a single primary server.

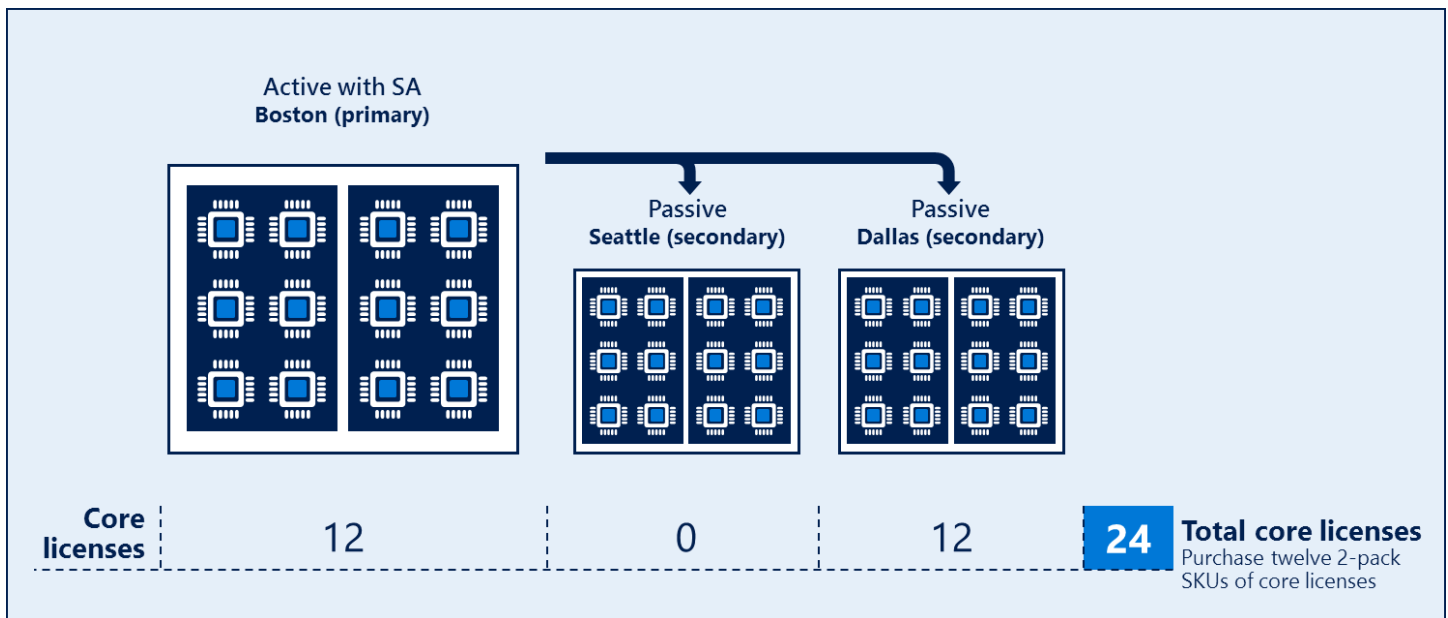

This figure shows an example of licensing an active primary SQL Server 2016 database with Software Assurance and multiple passive secondary databases.

### Additional Considerations for High Availability:

- When licensing SQL Server 2016 under the Per Core model, the number of core licenses must be based on the server that requires the higher number of licenses. This way, when the failover server takes over, it will be adequately licensed. For a passive instance of SQL Server to be properly licensed, it cannot require more core licenses than the licensed primary system.
- In the event that a passive instance of SQL Server becomes active for any reason, the primary SQL Server 2016 license is dynamically reassigned to the newly active server via the License Mobility within Server Farms Software Assurance benefit and now assumes all active workloads.
- When individual SQL Server instances are failing over independently from each other, each SQL Server OSE running an active SQL Server instance requires a separate license.

### AlwaysOn Availability Groups

Enhanced for SQL Server 2016 Enterprise Edition, AlwaysOn Availability Groups enable customers to configure multiple databases that will failover as a unit, with support for up to eight active secondary servers and three synchronous secondary servers. The ability to use secondary servers for more than just passive failover support can improve the performance of primary, reporting and backup workloads due to better balancing of workloads across instances, helping to provide better return on hardware investment.

**Note:** When secondary servers are actively used to support these additional workload scenarios—that is, when the servers used for failover purposes are no longer truly passive—they must be fully licensed accordingly.

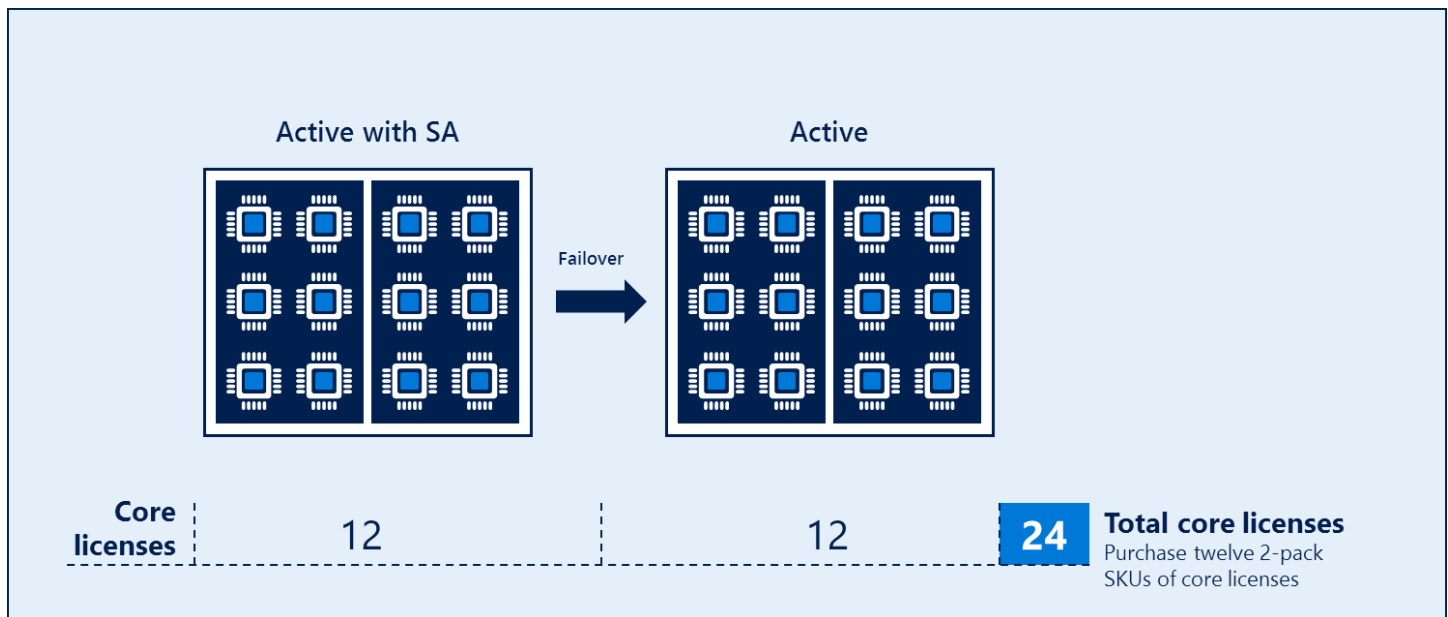

This figure shows an example of licensing an active primary SQL Server 2016 database with Software Assurance and an active secondary database.

Today, many virtual environments are becoming even more dynamic, especially in scenarios where software is used to automatically and dynamically allocate resources to different VMs “on the fly.” In the next section, we will discuss licensing SQL Server in these scenarios and look at ways to further simplify licensing management.

# Licensing SQL Server for Application Mobility

License Mobility is a use right that is available for all editions of SQL Server 2016 software licenses with active Software Assurance coverage. With this Software Assurance benefit, customers can reassign SQL Server licenses to different servers within a server farm as often as needed. Customers can also reassign licenses to third-party shared servers. License Mobility is available for licenses under both the Per Core and Server+CAL license models.

- SQL Server licenses that are not covered with active Software Assurance can be reassigned only to a different server within a server farm once every 90 days, and they cannot be reassigned to a third-party web hoster or non-private cloud at any time. (In the event of permanent hardware failure, the 90-day reassignment limit is waived.)
- All SQL Server licenses with active Software Assurance can be reassigned to another server within the server farm as often as needed; however, they can be reassigned only to another server in another server farm, or to a non-private cloud, once every 90 days.
  - A server farm may consist of up to two data centers located in time zones that are within four hours of one another and/or with the European Union (EU) and/or European Free Trade Association (EFTA).
  - A given data center may be part of only one server farm.
- License Mobility use rights do not apply to SQL Server PDW software.

License Mobility can benefit customers who license individual virtual machines (VMs) and then want to reassign those licenses to different servers within a server farm—as workloads move dynamically—or to VMs in cloud environments.

**Note:** License Mobility applies only to the reassignment of software *licenses* and is not applicable to the reassignment of running instances of SQL Server software.

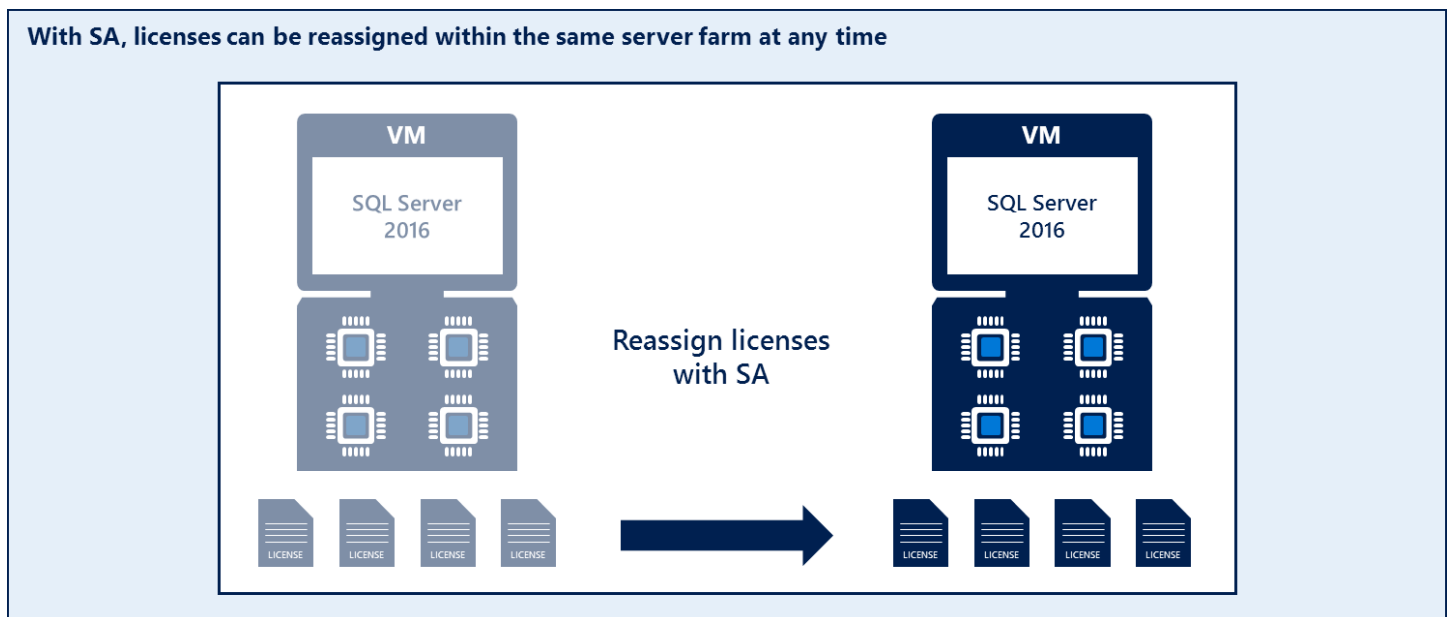

In this figure, core licenses are being reassigned within the same server farm through License Mobility.



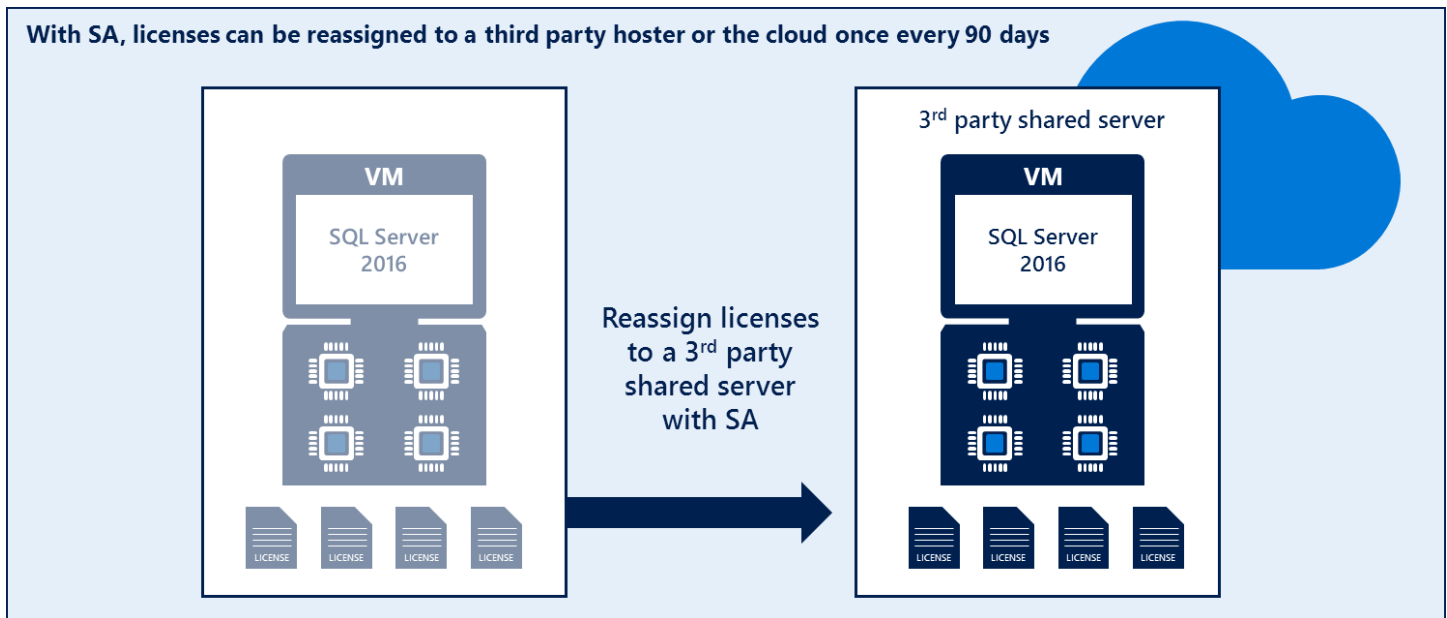

In this figure, core licenses are reassigned to a third-party shared server through License Mobility. Note that unlike License Mobility within a server farm, licenses can be reassigned to third party only once every 90 days.

- For more information on how to use License Mobility to extend the value of SQL Servers licenses, visit <http://www.microsoft.com/licensing/software-assurance/license-mobility.aspx>.

## Licensing SQL Server for Non-Production Use

Customers are required to license every Microsoft software product they install, configure, and use, including all physical and virtual instances. As such, licensing a development and test environment can be expensive and challenging to manage as new servers are set up and others are torn down. Microsoft offers multiple, cost-effective options for licensing SQL Server 2016 software for use in non-production environments.

### SQL Server Developer Edition

SQL Server 2016 Developer Edition is a fully featured version of SQL Server software—including all of the features and capabilities of Enterprise Edition—licensed for development, test, and demonstration purposes only. SQL Server Developer Edition may not be used in a production environment or with product data. Any test data that was used for design, development, or test purposes must be removed prior to deploying the software for production use.

Customers may install and run the SQL Server Developer Edition software on any number of devices. This is significant, because it allows customers to run the software on multiple devices (for testing purposes, for example) without having to license each non-production server system.

**Note:** A production environment is defined as an environment that is accessed by end users of an application (such as an Internet website) and that is used for more than gathering feedback or acceptance testing of that application. Other scenarios that constitute production environments include:

- Environments that connect to a production database.

- Environments that support disaster recovery or backup for a production environment.
- Environments that are used for production at least some of the time, such as a server that is rotated into production during peak periods of activity.

It is rare that someone whose primary role is designing, developing, or testing software would also qualify as an “end user” of the software.

**Note:** Effective April 1, 2016, SQL Server Developer Edition became a free product, available for download from the Microsoft Dev Essentials program. Customers who need prior versions and/or additional SQL Server editions for development, test, and demonstration purpose (for example, Standard or Enterprise editions), can access them through Visual Studio subscriptions.

- For more information on free Dev Essentials program, including how to register, visit <https://www.visualstudio.com/en-us/products/visual-studio-dev-essentials-vs.aspx>.

### Visual Studio Subscriptions

Customers can also choose to license SQL Server software for non-production use through certain Visual Studio subscription offerings, including the Visual Studio Professional and Enterprise subscription levels. Visual Studio subscriptions are licensed on a per user basis and the software cannot be used in a production environment.

- For more information on Visual Studio subscriptions that include access to SQL Server software, visit <http://www.visualstudio.com/products/visual-studio-with-msdn-overview-vs>.
- For more information on Visual Studio licensing scenarios, download the [Visual Studio 2015 Licensing White Paper](#).

### Product Evaluations

SQL Server 2016 Evaluation Edition is a fully functional trial version of SQL Server 2016 software that automatically expires after 180 days. Microsoft Commercial Licensing customers can also install and evaluate non-expiring software versions of any of the SQL Server 2016 products for 60 days before requiring a purchase.

- To discover the power of SQL Server 2016, download the free [SQL Server 2016 Evaluation](#).

## Licensing SQL Server in a Multiplexed Application Environment

“Multiplexing” refers to the use of hardware or software to pool connections, reroute information, or reduce the number of devices or users that directly access or use SQL Server. Multiplexing can also include reducing the number of devices or users SQL Server directly manages.

When licensing SQL Server software under the Server+CAL licensing model, users and devices that indirectly access SQL Server data through another application or hardware device still require SQL Server CALs.

- Multiplexing does not reduce the number of Microsoft licenses required. Users are required to have the appropriate licenses, regardless of their direct or indirect connection to SQL Server.

- Any user or device that accesses the server, files, data, or content provided by the server that is made available through an automated process requires a SQL Server CAL.
- The number of tiers of hardware or software between the SQL Server and the user or devices that ultimately use its data, services, or functionality does not affect the number of CALs required.
- Manual transfer of data from employee to employee does not necessitate the requirement of a CAL for the receiving employee. For example, if an employee sends a Microsoft Office Excel® version of a report to another employee, the receiving employee does not require a CAL (as long as the report does not access a server running SQL Server in some way).

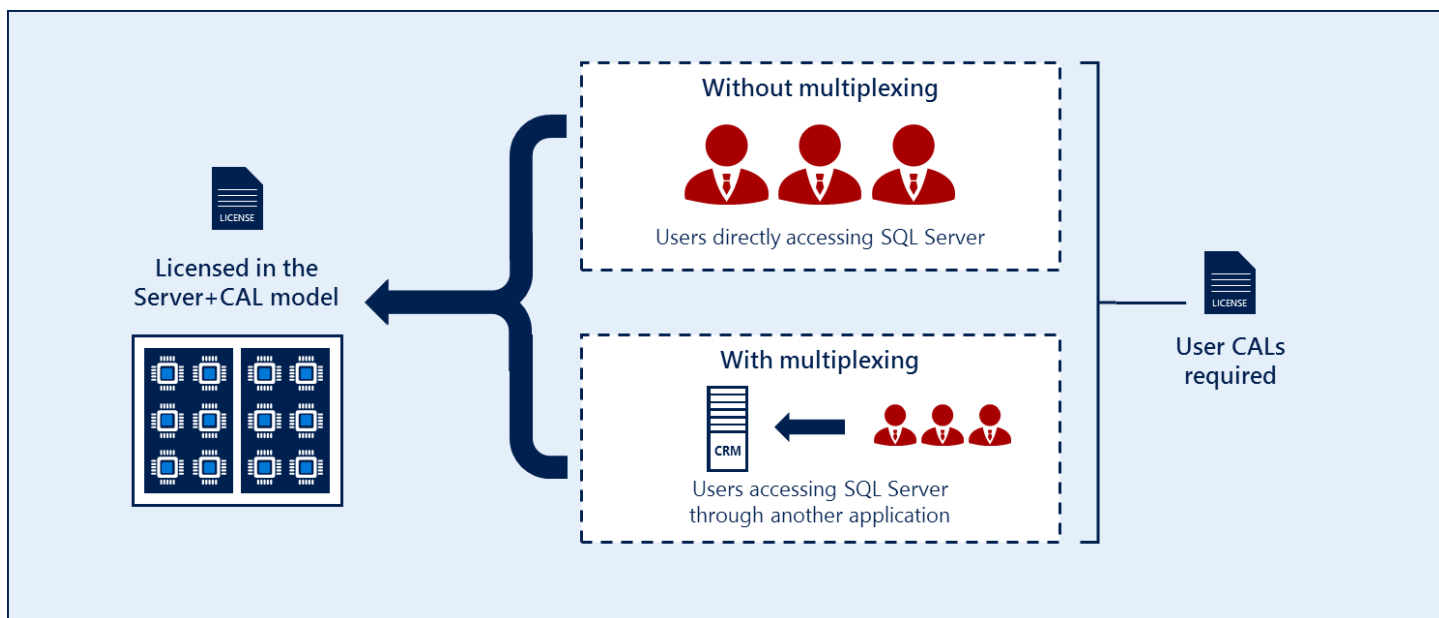

This figure illustrates the licenses used in the Server+CAL licensing model via multiplexing.

SQL Server CALs are required for users or devices that directly input into, query, or view data from a SQL Server database. Similarly, SQL Server CALs are required for users or devices that input data into, query, or view data from a SQL Server database through a pooling device (such as the CRM Server in the figure above). This includes users who view data through web-based applications or enter information into a database through an intermediary product.

When users actively send SQL Server data by email or other messaging technology, recipient users do not require a SQL Server CAL. With multiplexing, these rules do not change. Likewise, the paper distribution of data does not require SQL Server CALs for the recipients of the paper report. Users who receive data directly or indirectly from SQL Server require CALs, but if these users print the data, recipient users do not require a SQL Server CAL.

- ➔ For more details on how multiplexing affects the licensing of SQL Server 2016 products under the Server+CAL model, download the [Commercial Licensing Brief](#).

# Additional Product Information

## Upgrades, Downgrades, and Step-Ups

When licensing SQL Server 2016 software, several deployment options are available to support a variety of customer upgrade scenarios.

- **Version Upgrade Rights** are offered as a Software Assurance benefit for qualified licenses and allow customers access to upgrade their deployments at no additional cost. Existing SQL Server 2012 software licenses covered by Software Assurance are automatically upgraded to licenses for the corresponding SQL Server 2016 edition.
- **Cross-Edition Rights** are currently available for certain SQL Server products only and allow customers to deploy an alternate (usually lower) edition in place of the currently licensed edition. SQL Server cross-edition rights can be combined with the version downgrade rights (available for all products offered under a Commercial Licensing Agreement) that allow customers to deploy prior versions of the software in place of the currently licensed version. In some cases, rights to deploy prior versions of product editions other than the edition currently licensed may also be allowed.

**Note:** When using version downgrade or cross-edition deployment rights, the product use rights for the originally licensed version and edition still apply.

Software Deployment options for SQL Server 2016		
Customers Licensed for:	Can Choose to Deploy:	
	Software Edition	Software Version
SQL Server 2016 Standard Edition Server	SQL Server Standard Server	2016 or earlier
	SQL Server Workgroup	2008 R2 or earlier
	SQL Server for Small Business	2008 R2 or earlier
SQL Server 2016 Standard Edition Core	SQL Server Standard Core	2016 or earlier
	SQL Server Web (non-SPLA only)	2008 R2 or earlier
	SQL Server Workgroup	2008 R2 or earlier
SQL Server 2016 Enterprise Edition Core	SQL Server Enterprise Core	2016 or earlier
	SQL Server Business Intelligence	2014 or earlier
	SQL Server Standard Core	2016 or earlier
	SQL Server Datacenter	2008 R2 or earlier

This table shows deployment options available to customers with SQL Server licenses. SQL Server 2016 use rights apply.

- **Edition Step-Ups** are offered as a Software Assurance benefit in certain Commercial Licensing programs only and allow customers to move from a lower product edition. SQL Server 2016 Standard Edition Core licenses can step-up to SQL Server 2016 Enterprise Edition Core licenses only. To be eligible to step-up to a higher edition, the lower edition license must be covered by Software Assurance. Step-Ups between licensing models are not allowed.

## SQL Server 2016 Migration Options for Software Assurance Customers

To facilitate a smooth transition to the product edition and licensing model changes introduced with SQL Server 2012, Microsoft continues to offer several migration options to help customers who have invested in Software Assurance benefits to protect their current software investments.

### For SQL Server Business Intelligence Edition Licenses with Software Assurance

SQL Server 2014 was the last version of the SQL Server Business Intelligence Edition. Customers with active Software Assurance coverage on qualifying Business Intelligence Edition server licenses on June 1, 2016, are eligible to upgrade to and use SQL Server 2016 Enterprise (Server+CAL) software with those licenses.

- During the current term of Software Assurance coverage (effective on or before June 1, 2016), customers who are licensing SQL Server 2014 Business Intelligence Edition can, for a given deployment, upgrade to and use the SQL Server 2016 Enterprise Edition (Server+CAL) software in place of the licensed SQL Server 2014 edition. Note: Customers who upgrade to SQL Server 2016 software are subject to current version Enterprise Edition server license product terms.
- Customers with Enterprise Agreements effective on or before June 1, 2016, can continue to acquire additional SQL Server 2014 Business Intelligence server licenses—and upgrade those licenses to SQL Server 2016—through the end of their current enrollment term, as long as the number of new licenses acquired does not exceed more than 25 percent of the number of qualifying licenses acquired as of May 1, 2016.
- After their current term expires, Software Assurance coverage can be renewed and maintained on SQL Server Enterprise Edition server licenses to provide continued access to Software Assurance benefits, including License Mobility rights, Failover Server rights, and access to future releases.

### Additional Considerations for Customers Migrating to SQL Server Enterprise Edition Server Licenses

SQL Server 2016 Enterprise Edition software licensed under the Server+CAL model is intended and physically limited to run only on servers with a total of 20 or fewer cores:

- There are **two versions of SQL Server 2016 Enterprise Edition software**: a server-based version and a core-based version. Customers must run the software version for which they are licensed.
- For customers running SQL Server 2016 Enterprise Edition server-based software instances in a physical environment, that OSE is only permitted to access a maximum of 20 physical cores. A per instance technical limit is also enforced.
- For customers running SQL Server 2016 Enterprise Edition server licenses in virtual environments, each set of VMs associated with a single server license (up to four per server license) can only access up to 20 hardware threads of combined power at any time.

Existing SQL Server 2016 Enterprise Edition server licenses continue to have tremendous value, and with the availability of ongoing Software Assurance coverage, customers licensed under the Server+CAL model can retain access to the latest product enhancements and advanced capabilities of Enterprise Edition. As such, there are no programmatic conversions to core licenses.

### **For SQL Server Parallel Data Warehouse (PDW) Licenses with Software Assurance**

Since February 1, 2015, customers have been allowed to license SQL Server PDW software running on the Analytics Platform System (APS) with SQL Server Enterprise Edition core licenses covered by Software Assurance as an alternative to the “standalone” SQL Server PDW license offering.

As of June 1, 2016, Microsoft no longer offers SQL Server PDW-specific licenses and customers can only use Enterprise Edition core licenses with Software Assurance coverage to license APS appliances.

- Customers with Enterprise Agreements effective on or before June 1, 2016, can continue to acquire additional SQL Server PDW licenses—and upgrade those licenses to SQL Server 2016—through the end of their current enrollment term.
- After their current term expires, Software Assurance coverage can be renewed and maintained on SQL Server Enterprise Edition core licenses to provide continued access to PDW software deployment rights and Software Assurance benefits, including access to future software releases.

For full details on the migration options and additional license grants available to current Software Assurance customers with eligible SQL Server licenses, refer to the June 1, 2016, publication of the Microsoft Product Terms.

## Software Assurance Benefits

Software Assurance for Commercial Licensing helps boost IT productivity by enabling customers to get the most from Microsoft software products. Software Assurance benefits—including 24x7 support, deployment planning services, user and technical training, and the latest software releases and unique technologies—are combined in one cost-effective program.

Using these benefits can help customers improve productivity and help IT efficiently deploy and manage SQL Server software. As hardware capacity and licensing needs expand, SQL Server customers with Software Assurance coverage can enjoy the benefit of adding incremental licenses without regard to the software version licensed. Software licenses and use rights are version-specific and as such, licenses for different software versions cannot be combined when licensing a single operating system environment. As a benefit of having access to—and therefore always being licensed for—the latest version of SQL Server software, Software Assurance customers licensed under the core licensing model (for example) can easily combine current version core licenses with future version core licenses, without the need to track or otherwise reassign covered licenses based on software version alone.

**Note:** All licenses must be covered with Software Assurance and product use rights do not change when using downgrade rights to deploy prior software versions.

Software Assurance Benefits Overview	
Benefit	Description
Unlimited Virtualization	Allows customers to run any number of instances of SQL Server 2016 Enterprise Edition software in an unlimited number of VMs. Applicable under the core licensing model only.
Failover Servers	Allows customers to install and run passive SQL Server 2016 instances in a separate OSE or server for high availability in anticipation of a failover event.
License Mobility within a Server Farm	Allows reassignment of SQL Server 2016 licenses within a server farm more than once every 90 days. Does not apply to SQL Server PDW.
License Mobility through Software Assurance	Allows license reassignment of SQL Server 2016 to third party shared servers. Does not apply to SQL Server PDW.
Disaster Recovery Rights	Allows backup instances of SQL Server 2016 software for temporary use in a server dedicated to disaster recovery.
Special Migration Offers	Provides license grants and additional use terms for legacy SQL Server 2008 R2 customers who are still migrating to current SQL Server 2016 product editions and license models.
SQL Server Appliance Updates	Allows access to new product features and functionality between major appliance software releases. Applies to SQL Server PDW deployments only.
Additional Benefits for SCE Customers	In addition to the benefits noted above, Server Cloud Enrollment (SCE) customers may also qualify for premium benefits, including Unlimited Problem Resolution Support.

This table provides an overview of the benefits of Software Assurance.

Refer to the Commercial Licensing Product Terms for more details on these benefits and additional license grants available to SQL Server customers with Software Assurance, including any additional terms and conditions that may apply.

- For more information on the full set of Software Assurance benefits available to help customers deploy, manage, and maximize their SQL Server Commercial licensing purchases, visit <http://www.microsoft.com/licensing/software-assurance/default.aspx>.

## Additional Product Licensing Resources

For more information about licensing SQL Server 2016, including what is new with this version, please visit the following websites:

- For detailed SQL Server product licensing information, including new version features, edition comparisons, benchmarks, competitive comparisons and more, visit <http://www.microsoft.com/sqlserver/>.
- For SQL Server Product Terms, Product List details, licensing briefs, and other information on Microsoft Commercial Licensing topics, visit <http://www.microsoft.com/licensing/about-licensing/product-licensing.aspx>.
- For a list of dependent licenses required for SQL Server under the terms of Commercial Licensing Programs, download the [Software Dependency Guide](#).

© 2017 Microsoft Corporation. All rights reserved.

This document is for informational purposes only. MICROSOFT MAKES NO WARRANTIES, EXPRESS OR IMPLIED, IN THIS DOCUMENT. This information is provided to help guide your authorized use of products you license; it is not your agreement. Your use of products licensed under your commercial license agreement is governed by the terms and conditions of that agreement. In the case of any conflict between this information and your agreement, the terms and conditions of your agreement control. Prices for licenses acquired through Microsoft resellers are determined by the reseller.