



Introducing Windows Server 2016

John McCabe with the Windows Server team

PUBLISHED BY
Microsoft Press
A division of Microsoft Corporation
One Microsoft Way
Redmond, Washington 98052-6399

Copyright © 2016 by Microsoft Corporation

All rights reserved. No part of the contents of this book may be reproduced or transmitted in any form or by any means without the written permission of the publisher.

ISBN: 978-0-7356-9774-4

Microsoft Press books are available through booksellers and distributors worldwide. If you need support related to this book, email Microsoft Press Support at mspinput@microsoft.com. Please tell us what you think of this book at <http://aka.ms/tellpress>.

This book is provided “as-is” and expresses the author’s views and opinions. The views, opinions and information expressed in this book, including URL and other Internet website references, may change without notice.

Some examples depicted herein are provided for illustration only and are fictitious. No real

association or connection is intended or should be inferred.

Microsoft and the trademarks listed at <http://www.microsoft.com> on the "Trademarks" webpage are trademarks of the Microsoft group of companies. All other marks are property of their respective owners.

Acquisitions Editor: Kim Spilker

Developmental Editor: Bob Russell, Octal Publishing, Inc.

Editorial Production: Dianne Russell, Octal Publishing, Inc.

Copyeditor: Bob Russell

Visit us today at

MicrosoftPressStore.com

- **Hundreds of titles available** – Books, eBooks, and online resources from industry experts
- **Free U.S. shipping**
- **eBooks in multiple formats** – Read on your computer, tablet, mobile device, or e-reader
- **Print & eBook Best Value Packs**
- **eBook Deal of the Week** – Save up to 60% on featured titles
- **Newsletter and special offers** – Be the first to hear about new releases, specials, and more
- **Register your book** – Get additional benefits

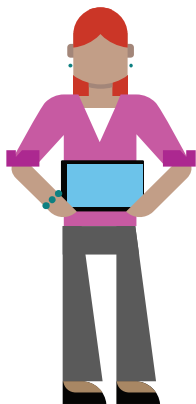

Contents

Introduction	viii
Acknowledgments.....	x
Free ebooks from Microsoft Press	xii
Errata, updates, & book support	xii
We want to hear from you	xiii
Stay in touch.....	xiii
Chapter 1: Introduction to Microsoft Windows Server 2016	1
Introduction	2
Cloud ready with Windows Server 2016.....	3
Security.....	5
Software-defined datacenter.....	8
Microsoft loves Linux!	13
System Center 2016.....	15
Chapter 2: Software-defined datacenter	22
Compute.....	23
Hyper-V	23
VM groups	31

True VM mobility.....	43
VM configuration version	51
New configuration file format.....	57
Production checkpoints.....	60
Hot add and hot remove for network adapters and memory	64
Failover cluster	71
Creating a cloud witness by using Azure....	72
Shared VHDX improvements.....	77
Improved cluster logs.....	82
Active memory dump.....	87
Network name diagnostics.....	90
Cluster operating system rolling upgrade .	92
Workgroup and multidomain clusters.....	105
SMB multichannel and multi-NIC cluster networks	106
VM improvements	107
Storage.....	108
Storage Replica	108
Scenarios	116
Storage Replica in Windows Server 2016.....	125

Storage Spaces Direct.....	128
Implementation details.....	136
Improved scalability	138
Storage Spaces Direct optimized pool.....	139
Failure scenarios	140
Deduplication	144
Storage Quality of Service.....	147
Networking.....	153
Network Controller.....	160
RAS Gateway multitenant BGP router.....	166
Software Load Balancing.....	170
Datacenter firewall.....	172
Web Application Proxy	174
Web Application Proxy troubleshooting .	199
Chapter 3: Application platform.....	210
Modernizing traditional apps	211
Microservices.....	214
Azure Hybrid Use Benefit	216
Nano Server	217
Understanding Nano Server	217
Deploying Nano Server	222

Specializing Nano Server	226
Remotely managing Nano Server	227
Service branching	234
Containers.....	236
What is a container?	236
Why use containers?	240
Windows Server containers versus Hyper-V containers	242
Chapter 4: Security and identity	257
Shielded VMs.....	258
Threat-resistant technologies	263
Control Flow Guard	264
Device Guard on Windows Server 2016... ..	265
What is Device Guard	265
Enhanced Kernel Mode protection using Hypervisor Code Integrity.....	266
Deploy configurable code Integrity policy	268
Create code Integrity policy for general server usage	270
Create code integrity policy for lockdown server.....	271
Deploy code integrity policy.....	273

Credential Guard	274
Remote credential guard	279
Windows Defender	281
Threat detection technologies.....	282
Securing privileged access	289
Just-in-Time and Just Enough Administration	289
A strategy for securing privileged access....	293
Short-term plan	297
Medium-term plan	301
Long-term plan	303
Identity	306
Active Directory Domain Services.....	306
Chapter 5: Systems management	325
Windows PowerShell improvements	326
Package management	329
Windows PowershellGet and NuGet	331
Windows PowerShell Classes	343
Windows PowerShell script debugging.....	345
Break All	346
Remote editing	346

Remote debugging	347
Job debugging	349
Runspace debugging.....	350
Desired State Configuration.....	352
DSC Local Configuration Manager.....	352
New methods in LCM.....	365
DSC partial configurations.....	368
Setting up the LCM Meta Configuration .	370
Authoring the configurations.....	375
Deploying the configurations	380
System Center 2016.....	382
Operations Management Suite	389
Server management tools	406
About the author	4167

Introduction

Windows Server has powered a generation of organizations, from small businesses to large enterprises. No matter what your role in IT, you can be guaranteed you that have touched Windows Server at some point in your career or at very least you have seen it from afar! This book introduces you to Windows Server 2016, which is the next version of Windows Server. No matter what your area of expertise, this book will introduce you to the latest developments in Windows Server 2016.

Each chapter has been written by either field experts or members of the product group, giving you the latest information on every improvement or new feature that is included in this version of Windows Server. This information will help you to prepare for Windows Server 2016 and give you the means to develop and design a path to introduce Windows Server 2016 into your environment and take full advantage of what is to come. This book is being written at a time when the product is still evolving and it should be noted that things might change or not appear in the final version of Windows Server 2016 when released. All guidance in the chapters

is meant to be tried and evaluated in a test environment; you should not implement it in a production environment.

This book assumes that you are familiar with key concepts surrounding Windows Server (i.e., Microsoft Hyper-V, Networking, and Storage) as well as cloud technologies such as Microsoft Azure. In this book, we cover a variety of concepts related to the technology and present scenarios with a customer focus, but it is not intended as a how-to or design manual. You can use other sources, including the online Microsoft resources, to stay up to date with the latest developments on the roles and features of Windows Server 2016. The online resources will also contain the latest how-to procedures and information about designing a Windows Server 2016 infrastructure for your business.

Acknowledgments

We'd like to thank all of the contributors who made this book possible:

- David Holladay
- Mitch Tulloch
- Ned Pyle

- Claus Joergensen
- Matt Garson
- John Marlin
- Robert Mitchell
- Deepak Srivastava
- Shababir Ahmed
- Ramnish Singh
- Ritesh Modi
- Jason M. Anderson
- Schumann Ge
- Yuri Diogenes
- David Branscome
- Shabbir Ahmed
- Ramnish Singh
- Andrew Mason
- Neil Peterson
- The staff at Microsoft Press who makes these titles possible!

Finally, to anyone I haven't directly mentioned, for all the help that has been provided, thank you!

Free ebooks from Microsoft Press

From technical overviews to in-depth information on special topics, the free ebooks from Microsoft Press cover a wide range of topics. These ebooks are available in PDF, EPUB, and Mobi for Kindle formats, ready for you to download at:

<http://aka.ms/mspressfree>

Check back often to see what is new!

Errata, updates, & book support

We've made every effort to ensure the accuracy of this book and its companion content. You can access updates to this book—in the form of a list of submitted errata and their related corrections—at:

<https://aka.ms/IntroWinServ2016/errata>

If you discover an error that is not already listed, please submit it to us at the same page.

If you need additional support, email Microsoft Press Book Support at mspinput@microsoft.com.

Please note that product support for Microsoft software and hardware is not offered through the previous addresses. For help with Microsoft software or hardware, go to <http://support.microsoft.com>.

We want to hear from you

At Microsoft Press, your satisfaction is our top priority, and your feedback our most valuable asset. Please tell us what you think of this book at:

<http://aka.ms/tellpress>

The survey is short, and we read every one of your comments and ideas. Thanks in advance for your input!

Stay in touch

Let's keep the conversation going! We're on Twitter: <http://twitter.com/MicrosoftPress>.

Introduction to Microsoft Windows Server 2016

Whether you are a small- to mid-size business, a large enterprise, or a cloud service provider, the demand on what IT must deliver is a rapidly changing landscape. Customers want to access their applications in a variety of ways and be confident that they can complete their daily tasks in a secure and efficient manner. They simply are not concerned about

how IT infrastructures are made up and the challenges that team's supporting these environments experience a day-to-day basis.

Introduction

If you run an IT environment today, how do you meet the aforementioned challenges? Can your applications and infrastructure meet the demands placed on it? Can you meet the rate of innovation the cloud offers or the agility and speed of delivery? In these respects, there are an increasing number of challenges facing the on-premises infrastructure.

However, not everyone is ready to move to the cloud, and there will be many cases in which you can't because of a multitude of reasons; for example, contractual commitments that stipulate data can't move to the cloud.

Even if you can't or don't want to move to the cloud today, it is still important that you begin the journey to modernize your infrastructure so that you can take advantage of all the developments and advances that Microsoft has

made gleaned from its cloud experience and incorporated into Windows Server 2016.

Cloud ready with Windows Server 2016

Simply put, Windows Server 2016 is the cloud-ready operating system (OS) that delivers new layers of security and Microsoft Azure-inspired innovation for the applications and infrastructure that power your business.

For this release, Microsoft has spent a considerable amount of time reaching out to customers and gathering feedback of what is important and how it can meet the future needs for customer's infrastructures. In this light, Microsoft categorized the feedback into three main pillars, which you can see listed in Figure 1-1. The figure also shows the core recurring topics customers wanted to address that has essentially driven the innovative features that appear in Windows Server 2016 today.

Security	Software-Defined Datacenter	Application Platform
Increasing breach incidents Identity is target of attacks Complex to secure virtual environments	Lack of integrity between solutions Difficult to deploy and operate Low-footprint server	No integration between Dev and Ops Fast and lightweight OS Difficult to plan for public cloud

Figure 1-1: Categories of feedback for Windows Server 2016

In response to this, Microsoft focused on these three pillars and provided a mission statement for each one, as shown in Figure 1-2.

Security	Software-Defined Datacenter	Application Platform
Block attacks and increase the security of your virtual machines, applications, and data with layers of protection built in to the operating system	Develop your datacenter to achieve cost-savings and flexibility with software-defined compute, storage, and network virtualization technologies inspired by Microsoft Azure	Innovate faster with an application platform optimized for both traditional and cloud-native apps

Figure 1-2: Key pillars and Microsoft’s corresponding mission statement for Windows Server 2016

Microsoft has used these pillars to drive innovative features backed up by what it’s learned from building and operating Azure and incorporate them directly into Windows Server 2016.

These pillars have defined promises built in to ensure that customers are clear about Microsoft's commitment that Windows Server 2016 is the platform of choice when considering security, software-defined datacenter features that can were born in Microsoft Azure and now exist on-premises, and as an application platform that can not only run traditional applications, but also provide the necessary frameworks to allow customers to prepare their applications for migration to the cloud.

The following subsections dive deeper into the pillars and what Microsoft promises to deliver and, more important, how it will deliver on these promises.

Security

Windows Server 2016 gives you the power to prevent attacks and detect suspicious activity with new features to control privileged access, protect virtual machines (VMs), and harden the platform against emerging threats. Here's what Windows Server 2016 can do for you:

- Prevent the risk associated with compromised administrative credentials

Using the new privileged identity management features, you can limit access

to *Just Enough* and *Just-in-Time* 1. And, using Credential Guard, you can prevent administrative credentials from being stolen by *Pass-the-Hash* attacks.

- Protect your VMs from compromised fabric administrators by using shielded VMs

A shielded VM is a Generation 2 VM that has a virtual Trusted Platform Module (TPM), is encrypted by using BitLocker, and can run only on approved hosts in the fabric.

- Reduce your datacenter footprint and increase availability with just-enough OS.

The new Nano Server deployment option is 25 times smaller than Windows Server, while still offering a desktop experience. This minimizes the attack surface, increases availability, and reduces deployment time, resource usage, and startup time.

- Add even more protection to every deployment of Windows Server 2016.

Whether you're running in any cloud or on-premises, you can take advantage of additional security features such as Code Integrity and Control Flow Guard to ensure that only permitted binaries are run and protect against unknown vulnerabilities.

- Detect malicious behavior through enhanced security auditing optimized for threat detection.

Using new audit categories for group membership and PNP to identify and add additional information to audit events, administrators can dive deeper than ever to discover new threats

- Defend against malware attacks by using the built-in antimalware

Windows Defender is now included in Windows Server 2016 and optimized to support the various server roles and integrate with Windows PowerShell for malware scanning.

- Limit exposure in case of a security intrusion

If you were to suffer a security breach, Windows Server 2016 can limit the exposure by segmenting your network based on workload or business needs using a distributed firewall and network security groups. You can apply rich policies within and across segments.

- Use Hyper-V Containers for a unique additional level of isolation for containerized

applications without any changes to the container image.

Hyper-V containers provide isolation at the hardware level, giving administrators the peace of mind that they have come to appreciate with hardware-based virtualization protection as it incorporates the same isolation methods.

Software-defined datacenter

Windows Server 2016 delivers a more flexible and cost-efficient OS for your datacenter, using software-defined compute, storage, and network virtualization features inspired by Azure.

Software-defined compute

The following list presents just some of the amazing new features that fall under the software-defined compute stack for Windows Server 2016:

- Minimize attack surface, increase availability, and reduce resource usage with just-enough OS using the Nano Server deployment option, which is 25 times smaller than Windows Server while still providing a desktop experience.

- Make the move to the cloud easier by running your workloads in Microsoft Hyper-V, the same hypervisor that runs Azure and Azure Stack.
- Deploy applications on multiple operating systems with best-in-class support for Linux on Hyper-V.
- Upgrade infrastructure clusters to Windows Server 2016 with zero downtime for your application/workload, and without requiring new hardware, using mixed-mode cluster upgrades. Support.
- Increase application availability with improved cluster resiliency to transient failures in the network and storage.
- Add incremental resiliency to your clusters by using Cloud Witness to connect to resources in Azure.
- Automate server management with native tools such as Desired State Configuration and Windows PowerShell 5.0.
- Manage Windows servers from anywhere by using the new web-based GUI—Server management tool—a service running in Azure. Especially useful for managing

headless deployment options such as Nano Server and Server Core.

Software-defined storage

The following list introduces some of the enterprise grade storage features coming in Windows Server 2016:

- Build highly available and scalable software-defined storage at a fraction of the cost of a Storage-Area Network (SAN) or Network-Attached Storage (NAS). Storage Spaces Direct uses standard servers with local storage to create converged or hyper-converged storage architectures.
- Create affordable business continuity and disaster recovery among datacenters with Storage Replica synchronous storage replication.
- Ensure that users of business-critical applications have priority access to storage resources using Storage Quality of Service (QoS) features.

Software-defined networking

The following lists some of the new features around software-defined networking coming in Windows Server 2016:

- Deploy complex workloads with hundreds of networking policies (isolation, QoS, security, load balancing, switching, routing, gateway, DNS, etc.) using a scalable network controller in a matter of seconds, similar to how we do it in Azure.
- Dynamically segment your network based on workload needs using an Azure-inspired distributed firewall and network security groups to apply rich policies within and across segments. Route or mirror traffic to third-party virtual appliances for even higher levels of security.
- Offer greater service availability with software-based scale-out and scale-up resiliency for both the infrastructure (host, software load balancer, gateway, network controller) and the workloads.
- Take control of your hybrid workloads, including running them in containers, and move them across servers, racks, and clouds utilizing the power of VXLAN and NVGRE

based virtual networking and multitenanted hybrid gateways.

- Optimize your cost/performance when you converge Remote Direct Memory Access (RDMA) and tenant traffic on the same teamed Network Interface Cards (NICs), thereby driving down cost while providing needed performance guarantees at 40G and beyond.

Application platform

Windows Server 2016 delivers new ways to deploy and run your applications, whether on-premises or in Azure, using new capabilities such as Windows containers and the lightweight Nano Server deployment option.

- Containers in Windows Server 2016 offer the agility and density required for modern cloud applications. Windows Server containers brings containers to the Windows ecosystem and Hyper-V containers with its additional layer of isolation for sensitive applications with no additional coding required.
- Use the lightweight Nano Server deployment option for the agility and flexibility today's application developers need. It's the perfect

option for running applications from containers or micro services.

- Run traditional first-party applications such as SQL Server 2016 with best-in-class performance, security and availability.
- Save money by bringing the Windows Server licenses you own to Azure, and pay the lower base compute rate with the Azure Hybrid Use Benefit. (SA required.)
- Service Branching

With Nano Server, you get more active updates to the operating system, which will enable new features during its lifecycle and give developers the tools to consistently adopt the latest Agile and/or secure technologies that Microsoft deploys.

Throughout this book we will examine each of these elements closely and provide further information about each category and feature mentioned.

Microsoft loves Linux!

It is no secret that Microsoft has made major investments to ensure Linux gets an enterprise grade experience in the Microsoft ecosystem.

Microsoft has made contributions to the Linux kernel and actively maintains the Linux Integration Services (LIS) to ensure a fully enlightened experienced while running Linux on Hyper-V.

Microsoft fully supports the following distributions on Hyper-V today, with more being added in the future.

- Red Hat Linux
- SUSE
- OpenSUSE
- CentOS
- Ubuntu
- Debian
- Oracle Linux

Table 1-1 lists just some of the investments that have been made to the LIS.

Table 1-1: Key investment areas for LIS

Focus area	Description
Networking	Full virtual Receive-Side Scaling (vRSS) support to

	optimize Linux networking performance Hot-Add/Remove of virtual NICS
Storage	Hot-Add disk support and online re-size of storage
Management	Simplified management with common tools like PowerShell DSC
Performance	Linux performance on Hyper-V is fully competitive versus competitive hypervisors

System Center 2016

As we have mentioned, Windows Server 2016 is a cloud-ready OS boasting many new features that have been inspired by Azure. These features can act as the foundation of a software-defined datacenter (SDDC). However, clouds—be they public or private—need to be managed and System Center 2016 is the datacenter management tool that has benefitted from the key investments to achieve this.

System Center 2016 has been updated to unlock all of the key capabilities within Windows Server 2016, which make it possible for you to

implement and manage a full SDDC based on Windows Server 2016.

The following are just a few of the investments included in the release for System Center 2016:

- Device Management

This includes support for Windows 10 deployments, MDM enrollment with Azure Active Directory, and access restriction based on device enrollment and policy.

- Provisioning

Investments here include support for Windows Server 2016 Hyper-V features, rolling cluster upgrades, simplified networking, shielded VM provisioning, guarded host management, and support for vCenter 5.5.

- Monitoring

For the category, Microsoft has added support for Nano Server, Windows storage, SMI-S, MP catalog, performance improvements, Enhanced Data Visualization, and the SCOM Partner Program.

- Automation

Improvements here include easier migration to the cloud, SCO integration packs, and runbooks.

- Self-Service

In the area of self-service, you can benefit from improved usability and performance, an HTML5 self-service portal, and the new exchange connector.

- Data Protection

Here, you can take advantage of investments that include support for Azure Express Route, shielded VM, and Storage spaces direct.

All of these improvements in the System Center suite give organizations the power they need to create the next generation of the cloud. However, the investments don't stop there, System Center 2016 can now natively access new integrations into Microsoft Operations Management Suite.

This integration unlocks new possibilities to complement the already wide-ranging capabilities of System Center and gives administrators greater visibility, protection, control, and security into their IT environment at cloud scale. Operations Management Suite

reporting capabilities and native integration into Microsoft Power BI with which administrators can create powerful and dynamic reports and visualizations in a matter of clicks.

Figure 1-3 shows you a sample dashboard that is driven from the default intelligence packs included with the Operations Management Suite subscription. You can see that by default when you deploy these intelligence packs and connect data sources, you can work with rich visual information.



Figure 1-3: The Operations Management Suite dashboard

When you click a “Tile,” you can explore yet more in-depth information about the area of focus. By default, each intelligence pack comes with its own set of rules, but within a few clicks, administrators can generate rulesets related to their needs and subsequently create

visualizations of that information in more powerful and creative ways.

Operations Management Suite can complement your existing deployment of System Center, or it can act as a standalone platform, managing systems deployed across any cloud and on-premises environment.

The Operations Management Suite platform is divided into the following pillars:

- Insights and Analytics

This pillar focuses on collecting data from multiple sources, correlating activities, and providing mechanisms with which you can act on the results using alerts and searches to trigger activities. It is also capable of mapping and understanding the dependencies of workloads in the same capacity.

- Security and Compliance

This pillar, which is built from Microsoft security data and analysis, helps you to prevent, detect, and respond to threats more effectively than ever before. With the increased visibility into what is happening into your environment, you can mitigate situations and enforce policies to fully

control your IT ecosystem that spans the cloud.

- Automation and Control

This pillar concentrates on giving back control to IT administrators. Here, you can trigger runbooks from alerts generated in the Insights and Analytics pillar and driving operational efficiencies through automation.

- Protection and Recovery

This pillar is based on giving simple and efficient cloud backup and disaster recovery to organizations today. With it, you can automate your disaster recovery runbook in a controlled and efficient manner, ensuring success every time.

Although these pillars are important to understand what makes up the Operations Management Suite and how you can approach your adoption of the suite. It does not represent all of the potential solution packs available or coming in the gallery today. Figure 1-4 depicts the solution packs customers can use to gain further intelligence and visibility on their IT environment, both today and what's coming in the future:



Figure 1-4: Solutions available in Operations Management Suite today as well as future solutions

We will examine Operations Management Suite in greater depth later in this book and show some simple examples of how it complements Windows Server 2016.

Software-defined datacenter

In this chapter, we dive into the new or improved features in Windows Server 2016 that can bring a software-defined datacenter to life. If you are cloud service provider or want to build a platform to host your next generation of applications, Windows Server 2016 is the key to achieving this task. This chapter is broken into three main components: Compute, Storage, and Networking. These components are the underpinning to any software-defined datacenter,

and in each section we will examine them into more detail.

Compute

In this section we focus on everything Compute with a major focus on Hyper-V and what is new within Windows Server 2016. We will discuss all the features which will underpin world class software defined datacenters.

Hyper-V

By Robert Mitchell, Deepak Srivastava, Shabbir Ahmed, and Ramnish Singh

Microsoft Hyper-V virtualization technology has been enhanced in a number of ways in Windows Server 2016, and this section describes several of these improvements. Robert Mitchell demonstrates a new feature called Virtual Machine Groups and also describes the new cross-version virtual machine (VM) mobility capabilities of the platform. Deepak Srivastava walks you through the new VM configuration version, new configuration file format, and new support for using checkpoints in production environments. Finally, Shababir Ahmed and

Ramnish Singh demonstrate the new hot add and remove capability for network adapters and memory that is now supported by the Hyper-V role.

Scale

Windows Server 2016, delivers new industry-leading scalability to virtualize any and every workload without exception. The following table shows you a comparison of the journey we have taken from Windows Server 2012/2012R2 to now:

Description	Windows Server 2012/2012 R2, Standard and Datacenter	Windows Server 2016 Standard, and Datacenter
Physical (host) memory support	Up to 4 TB per physical server	Up to 24 TB per physical server (6x)
Physical (host) logical	Up to 320 LPs	Up to 512 LPs

processor support		
VM memory support	Up to 1 TB per VM	Up to 16 TB per VM (16x)
VM virtual processor support	Up to 64 VPs per VM	Up to 240 VPs per VM (3.75x)

Nested virtualization

Nested virtualization makes it possible for you to run Hyper-V as a guest VM running on Hyper-V! It exposes hardware virtualization extensions to a VM. There are some requirements for running this technology:

- Windows Server 2016 or Windows 10
- Minimum 4 GB RAM for the Host
- Intel VT-x processors (as of this writing)
- EPT Support
- Nested VM running Hyper-V must have dynamic memory disabled

To turn on nested virtualization, first, on the host, you must run the following Windows PowerShell command against a VM that you have created but have not yet turned on.

```
Set-VMProcessor -VMName <VMName> -  
ExposeVirtualizationExtensions $true
```

If you want to provide connectivity options for the guest VMs that will reside within your nested Hyper-V machine, you have two choices. The first option is to turn on MAC spoofing for the guest VM. This will allow its guest VMs to send traffic over the network. To turn on MAC spoofing on the host Hyper-V switch, use the following command:

```
Get-VMNetworkAdapter -VMName <VMName> | Set-  
VMNetworkAdapter -MacAddressSpoofing On
```

Your second option is NAT. You need to turn on NAT on the nested Hyper-V VM by using the following commands:

```
new-vmswitch -name VmNAT -SwitchType Internal
```

```
New-NetNat -Name LocalNAT -  
InternalIPInterfaceAddressPrefix "192.168.100.0/24"
```

When this is done, you need to assign an IP address to the new internal adapter. This essentially will be the gateway address for the VMs running under the nested Hyper-V. Here's the Windows PowerShell command to do this:

```
get-netadapter "vEthernet (VmNat)" | New-  
NetIPAddress -IPAddress 192.168.100.1 -AddressFamily  
IPv4  
-PrefixLength 24
```

Each nested guest VM needs to have an IP address set and its gateway set as follows:

```
get-netadapter "Ethernet" | New-NetIPAddress -  
IPAddress 192.168.100.2 -DefaultGateway  
192.168.100.1 -AddressFamily IPv4 -PrefixLength 24
```

More info See the following link
https://msdn.microsoft.com/virtualization/hyperv_on_windows/user_guide/nesting.

Linux secure boot

Linux VMs that are created as Generation 2 VMs can now utilize secure boot. To do this, you must turn on the VM to use the Microsoft UEFI Cert Authority by running the following Windows PowerShell command:

```
Set-VMFirmware vmname -SecureBootTemplate  
MicrosoftUEFICertificateAuthority
```

You also can turn on secure boot via the Hyper-V manager or Virtual Machine Manager.

Currently, only certain distributions support secure boot:

- Ubuntu 14.04 and later
- SUSE Linux Enterprise Server 12 and later
- Red Hat Enterprise Linux 7.0 and later

- CentOS 7.0 and later

Integration services

Updates to integration services for Windows guests are distributed through Windows Update. For service providers and private cloud hosters, this puts the control of applying updates into the hands of the tenants who own the VMs. Tenants can now update their Windows VMs with all updates, including the integration services, using a single method.

Hyper-V Manager improvements

There are some new improvements to the Hyper-V Manager. Let's take a look at them:

- **Alternate credentials support** You can now use a different set of credentials in Hyper-V Manager when you connect to another Windows Server 2016 or Windows 10 remote host. You also can save these credentials to make it easier to sign in again.
- **Manage earlier versions** With Hyper-V Manager in Windows Server 2016 and Windows 10, you can manage computers running Hyper-V on Windows Server 2012, Windows 8, Windows Server 2012 R2, and Windows 8.1.

- **Updated management protocol** Hyper-V Manager has been updated to communicate with remote Hyper-V hosts using the Web Services Management (WS-MAN) protocol, which permits CredSSP, Kerberos, or NTLM authentication. When you use CredSSP to connect to a remote Hyper-V host, you can do a live migration without turning on constrained delegation in Active Directory. The WS-MAN–based infrastructure also makes it easier to set up a host for remote management. WS-MAN connects over port 80, which is open by default.

Host resource protection

One of the problems with virtualization has always been the struggle to prevent a VM from using more than its fair share of resources. This overuse could potentially affect the host system performance and guest VMs. By default, this monitoring and protection is turned off; to turn it on, run the following:

```
Set-VMProcessor -EnableHostResourceProtection $true
```

This will turn on a monitoring process that scans for excessive usage and will limit the resources of any VM that might be causing the issue, thereby isolating the impact.

Connected Standby

When the Hyper-V role is installed on a computer that uses the Always On/Always Connected (AOAC) power model, the Connected Standby power state is now available.

Device assignment

Using this feature, you can give a VM direct and exclusive access to some PCIe hardware devices. Using a device in this way bypasses the Hyper-V virtualization stack, which results in faster access.

More info See the following link
<http://blogs.technet.com/b/virtualization/archive/2015/11/19/discrete-device-assignment.aspx>.

Windows PowerShell Direct

Windows PowerShell Direct gives you a way to run Windows PowerShell commands in a VM from the host. Windows PowerShell Direct runs between the host and the VM. This means it doesn't require networking or firewall requirements, and it works regardless of your remote management configuration.

Windows PowerShell Direct works much like remote Windows PowerShell except that you do not need network connectivity.

To connect to the VM from a host, use the `Enter-PSSession` cmdlet, as follows:

```
Enter-PSSession -VMName <VMName>
```

You will be prompted for credentials and then you can manage the VM from this `PSSession`.

The `Invoke-Command` cmdlet has been updated to perform similar tasks; for example, you can execute a script from the host against the VM, as shown here:

```
Invoke-Command -VMName <vmname> -FilePath  
C:\Scripts\MyTestScript.ps1
```

Remote Direct Memory Access

In Windows Server 2016, you can now turn on Remote Direct Memory Access (RDMA) on NICs that are not teamed or without Switch Embedded Teaming (SET). We discuss this later in this chapter.

More info To learn more about working with RDMA, go to <https://technet.microsoft.com/library/mt403349.aspx>.

VM groups

To make the management of multiple VMs easier, Windows Server 2016 has added support

for groupings of VMs. VM groups are exactly what the name implies: logical groupings of VMs.

There are two different types of groups:

- VM collections
- Management collections

A *VM collection* group is a logical collection of VMs. This type of group makes it possible for administrators to carry out their tasks on specific groups, rather than having to carry them out on each individual VM separately.

A *management collection* group is a logical collection of VM collection groups. With this type of group, administrators can nest VM collections as needed.

In Hyper-V Manager, it is possible to carry out operations on multiple VMs simply by selecting multiple objects, as illustrated in Figure 2-1

Virtual Machines		
Name	State	CPU Usage
VM1	Running	0 %
VM2		0 %
VM3		0 %

Connect...
Settings...
Turn Off...
Shut Down...
Save
Pause
Reset
Checkpoint
Export...
Help

Figure 2-1: Options available on VM

You can carry out these tasks without using VM groups, but the effort is somewhat limited. You can do more by using VM groups. Two scenarios for which VM groups are useful are backups and VM replicas. Even though it is fairly easy to back up or replicate a VM, and although such functionality has been included in Windows Server for some time, all VMs are dealt with separately. In some situations, because of distributed applications, VMs should be treated as a unit. This is true in both backup and VM replica situations.

Creating VM collections

The following new Windows PowerShell cmdlets have been introduced to facilitate scripting:

- `New-VMGroup`
- `Get-VMGroup`
- `Remove-VMGroup`
- `Add-VMGroupMember`
- `Remove-VMGroupMember`
- `Rename-VMGroup`

As of this writing, VM group management tools are still being developed; however, they will be visible in Windows PowerShell, Hyper-V Manager, and the upcoming version of Microsoft System Center Virtual Machine Manager.

To group together the three example VMs shown in Figure 2-2, you need to do the following:

1. Create a VM group.
2. Add the VMs to the group membership.

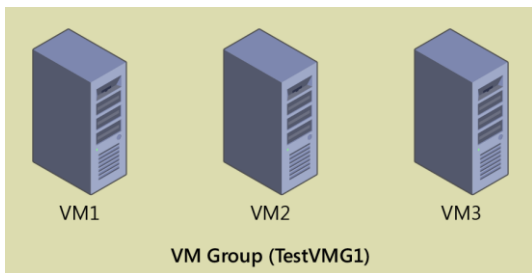

Figure 2-2: VM Groups

The code that follows is a Windows PowerShell script that will accomplish our goals. Keep in mind that the VM group being created is a VM collection group. Only VM collection groups can have VMs directly placed within them.

```
#Setup VM variables
$VM1 = Get-VM -Name VM1
$VM2 = Get-VM -Name VM2
$VM3 = Get-VM -Name VM3

#Create new VM Group
New-VMGroup -Name TestVMG1 -GroupType
VMCollectionType

#Setup VM Group variable
$TestVMG1 = Get-VMGroup -Name TestVMG1

#Add VMs to the group/collection
Add-VMGroupMember -VMGroup $TestVMG1 -VM $VM1
Add-VMGroupMember -VMGroup $TestVMG1 -VM $VM2
Add-VMGroupMember -VMGroup $TestVMG1 -VM $VM3
```

The result of these steps is a VM group that contains three VMs.

You can verify this by using the management tools and querying either the VMs or the VM groups. The following example shows how to do this by utilizing the `Get-VM` and `Get-VMGroup` cmdlets, respectively:

```
PS C:\> Get-VM | ft Name, state, groups - AutoSize
```

Name	State	Groups
VM1	Running	{TestVMG1}
VM2	Running	{TestVMG1}
VM3	Running	{TestVMG1}

```
PS C:\> Get-VMGroup * | ft Name, vmmembers -AutoSize
```

Name	VMMembers
TestVMG1	{VM2, VM3, VM1}

The updated `Get-VM` cmdlet lists what groups (if any) of which the VM is a member. A VM can be a member of multiple groups. If this is the case, the `Get-VM` cmdlet will return a list of multiple groups.

The new `Get-VMGroup` lists any VMs that are members of a specified group, or, as in the preceding example, in which we use a wildcard, all existing groups. In the example, we query all groups because we know there is just one. However, we can add one of the VMs to the membership of second group. Here is a quick Windows PowerShell script that will do just that:

```
#Create new VM Group
New-VMGroup -Name TestVMG2 -GroupType
VMCollectionType

#Setup VM Group variable
$TestVMG2 = Get-VMGroup -Name TestVMG2

#Add VMs to the group
Add-VMGroupMember -VMGroup $TestVMG2 -VM $VM1
```

Using the Get-VM cmdlet, you can see that VM1 now belongs to both the TestVMG1 group and the new TestVMG2 group:

```
PS C:\> Get-VM | ft Name, state, groups - AutoSize
```

Name	State	Groups
VM1	Running	{TestVMG2, TestVMG1}
VM2	Running	{TestVMG1}
VM3	Running	{TestVMG1}

Using the Get-VMGroup cmdlet, you now see both groups and VM1 are members of both VM groups:

```
PS C:\> Get-VMGroup * | ft Name, vmmembers -AutoSize
```

Name	VMMembers
TestVMG2	{VM1}
TestVMG1	{VM2, VM3, VM1}

There are now two VM groups: one comprising three VMs, and the other with a single VM, as shown in Figure 2-3.

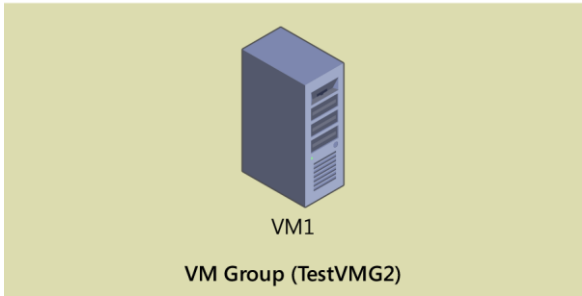
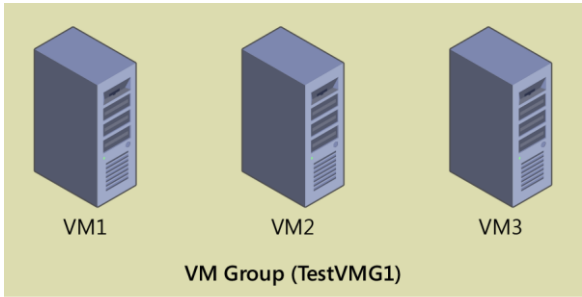

Figure 2-3: Multiple VM groups

With the two VM groups established, you can carry out actions directed at VM1, VM2, and VM3 by utilizing TestVMG1. You can perform actions directed only at VM1 by utilizing TestVMG2.

Creating management collections

VM collections are fairly simple. They maintain a membership of VMs. Management collections, on the other hand, maintain a membership of VM collections. Figure 2-4 shows a management group that contains both of the VM groups that were created earlier. Those VM groups contain actual VMs. Note that VMs cannot directly belong to the membership of a management collection.

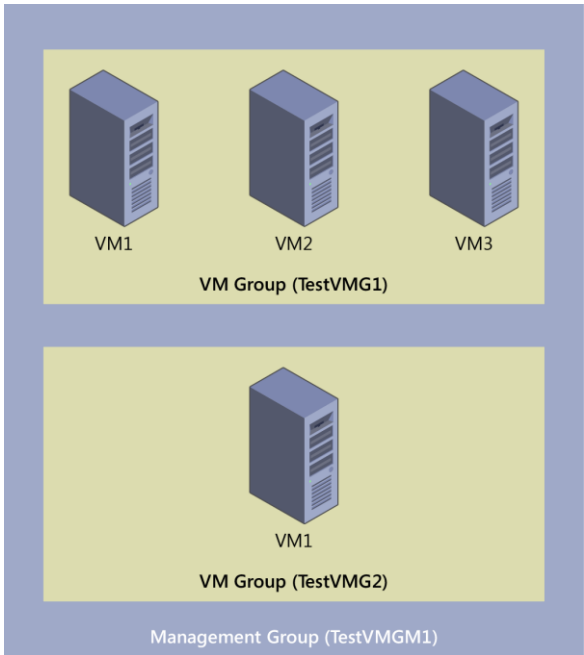

Figure 2-4: Single management group containing multiple VM Groups

Creating management groups is nearly identical to creating VM groups using the management tools previously outlined. The following Windows PowerShell script creates a new management group and adds both of the existing VM groups to it:

```
#Create new Management Group
New-VMGroup -Name TestVMGM1 -GroupType
ManagementCollectionType

#Setup Management Group variable
$TestVMGM1 = Get-VMGroup -Name TestVMGM1

#Add VM Groups to the Management Group
Add-VMGroupMember -VMGroup $TestVMGM1 -VMGroupMember
$TestVMG1
Add-VMGroupMember -VMGroup $TestVMGM1 -VMGroupMember
$TestVMG2
```

An interesting difference between VM groups and management groups is that management groups can contain both VM groups and other management groups. Put simply, this means that you can nest management groups.

The following Windows PowerShell script creates a new management group named `Outside` and adds our first management group, `TestVMGM1`, to its membership:

```
#Create new Management Group
New-VMGroup -Name OutsideGroup -GroupType
ManagementCollectionType

#Setup Management Group variable
$OutsideGroup = Get-VMGroup -Name OutsideGroup

#Add VM groups to the Management Group
Add-VMGroupMember -VMGroup $OutsideGroup -
VMGroupMember $TestVMGM1
```

The management group (`OutsideGroup`) contains another management group (`TestVMGM1`), which contains the two VM

groups (TestVMG1 and TestVMG2), which contain different groupings of three VMs (VM1, VM2, and VM3), as demonstrated in Figure 2-5.

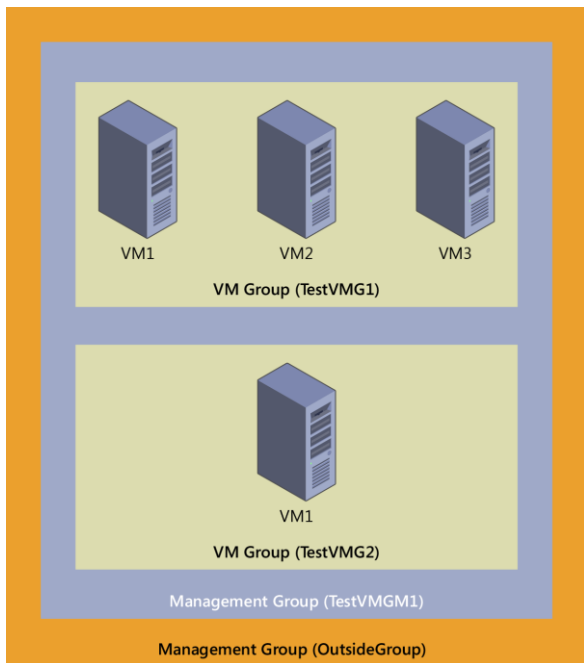

Figure 2-5: Multitier management groups

Finally, you can use the previously described management tools to determine which VMs and which groups are members of other groups.

Obviously, this nesting capability opens an entirely new dimension in how you can organize VMs. VMs become objects that you can group much like user and computer objects in Active Directory. This will be more visible when you use this capability in conjunction with the upcoming version of Virtual Machine Manager.

True VM mobility

Being able to move VMs from one host to another has been a must since the inception of Hyper-V. In the early days of Hyper-V, during the Windows Server 2008 timeframe, only offline migration was possible (see Figure 2-6). The VM was taken offline, moved, and then brought back online. This was done by using the export and import functionality. Although this offered some VM mobility, it was restrictive in that it required downtime for the VM.

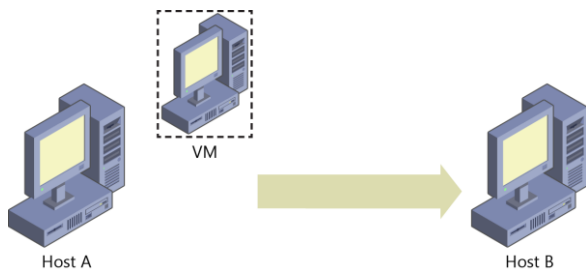

Figure 2-6: Offline migration

In Windows Server 2008 Hyper-V, you could move a VM from one host to another host only when the VM was offline.

Later, with the release of Windows Server 2008 R2, live migration made it possible for the first time to move a VM while it was still running. However, live migration was available only between clustered Hyper-V hosts where the VMs lived on a cluster shared volume (CSV), as shown in Figure 2-7.

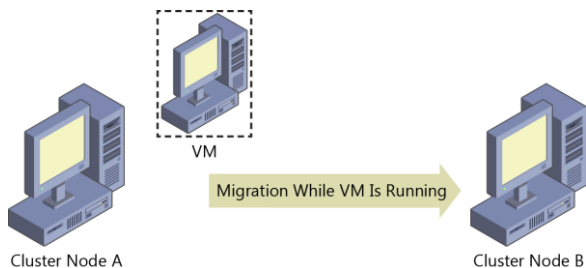

Figure 2-7: Live migration

Windows Server 2008 R2 Hyper-V introduced the ability to move running VMs from one cluster node to another cluster node.

A completely new level of freedom came with Windows Server 2012 and its ability to live-migrate VMs between any Hyper-V hosts of the same version (see Figure 2-8), regardless of

whether either the source or destination was part of a failover cluster.

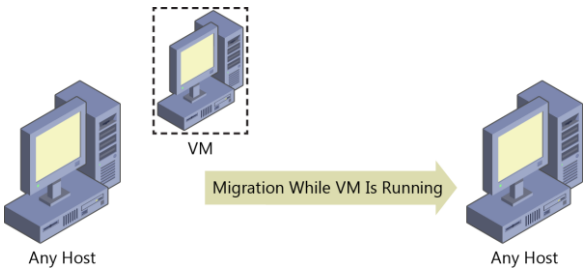

Figure 2-8: Any host, same OS live migration

Windows Server 2012 Hyper-V introduced the ability to move running VMs from any host to any other host.

Windows Server 2012 R2 took live migration a step further, introducing the first "cross version" live migration. VMs could live-migrate from any Windows Server 2012 host to any Windows Server 2012 R2 host, regardless of its membership in a failover cluster (see Figure 2-9).

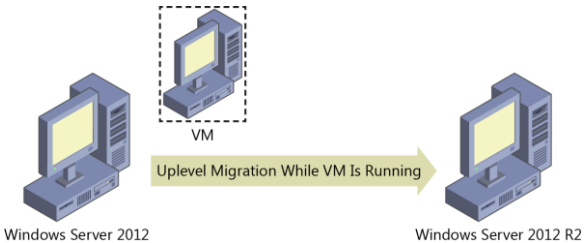

Figure 2-9: 2012 to 2012 R2 live migration

Windows Server 2012 R2 Hyper-V introduced the ability to move running VMs from a host running Windows Server 2012 to a host running Windows Server 2012 R2.

Windows Server 2016 breaks yet another boundary with down-level migration, giving administrators true freedom of control over their VMs. Previously, live migration would work only between hosts running the same version of Windows Server or the next version of Windows Server. The table that follows summarizes the migration options available for Hyper-V in each version of Windows Server running on the host:

Host operating system	Migration options
Windows Server 2008	Offline migration only
Windows Server 2008 R2	Live migration only between cluster nodes
Windows Server 2012	Live migration into or out of cluster
Windows Server 2012 R2	Live migration into or out of cluster, and from down-level Windows Server

Windows Server 2016	Live migration into or out of cluster, and to up-level or down-level Windows Server
---------------------	---

Windows Server 2016 is the only version that gives you the ability to live-migrate to a host running an earlier version of Windows Server (see Figure 2-10).

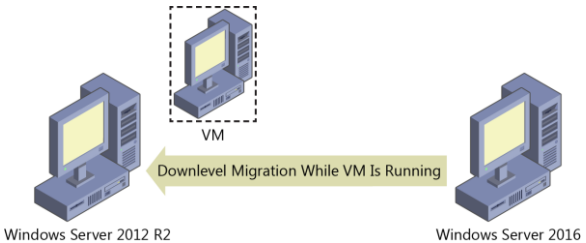

Figure 2-10: Migration from 2016 to an earlier version of Windows Server

Windows Server 2016 Hyper-V introduces the ability to move running VMs to a host running an earlier version of Windows Server.

For VMs on Windows Server 2016 to live-migrate to earlier versions of Windows Server, the following must be true:

- Both hosts must be members of the same Active Directory.

- Both hosts must have live-migration functionality turned on.

Turning on live migration has not changed from previous versions. On the host device, go to the Hyper-V Settings dialog box and select the Enable Incoming and Outgoing Live Migrations option, and then select from where you would like to receive incoming live migrations, as shown in Figure 2-11.

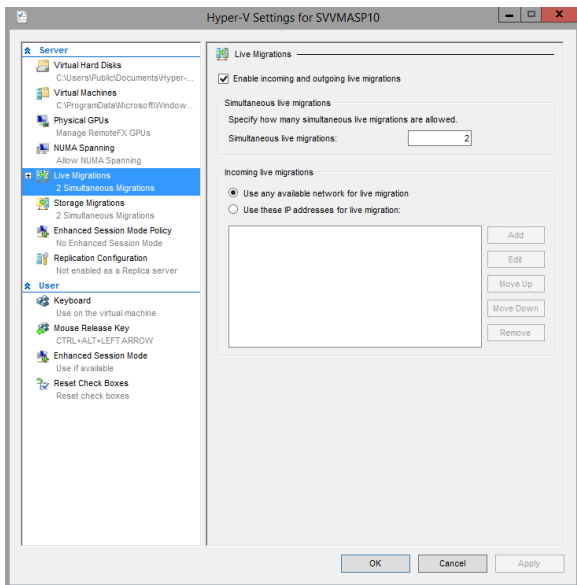

Figure 2-11: Live migration settings for a host

The mechanics of performing a live migration are the same as they were in previous versions of Windows Server. There are three ways to carry out the process:

- Use Hyper-V Manager on the host
- Create a script in Windows PowerShell
- Use Virtual Machine Manager (not included as part of Windows Server)

When using Hyper-V Manager, right-click the VM that you want to migrate and then, on the shortcut menu, select Move, as shown in Figure 2-12.

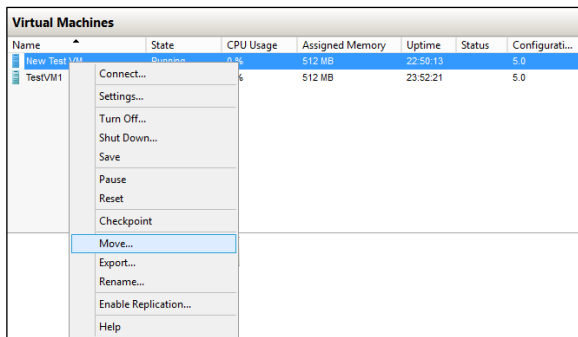

Figure 2-12: VM shortcut menu

To do the same operation using Windows PowerShell, use the Move-VM cmdlet. The

following example moves a VM named New Test VM to a destination server named Hyper-Server:

```
PS C:\> Move-VM "New Test VM" Hyper-Server
```

Note The preceding cmdlet moves the VM to the Hyper-V host's default location.

Keep in mind that even though any VM can live-migrate from Windows Server 2012 to any newer Windows Server host, only version 5.0 VMs can migrate from Windows Server 2016 down to Windows Server 2012 R2. You can view the version in Hyper-V Manager (shown in Figure 2-13) or by utilizing the Get-VM cmdlet in Windows PowerShell.

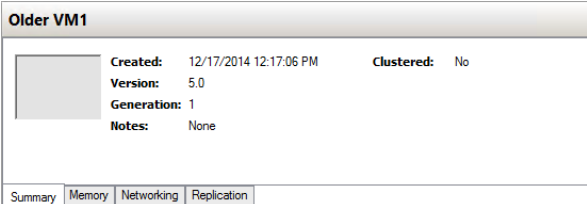

The screenshot shows the details for a VM named "Older VM1". On the left is a grey placeholder icon. To the right, the following information is displayed:

Created:	12/17/2014 12:17:06 PM	Clustered:	No
Version:	5.0		
Generation:	1		
Notes:	None		

At the bottom, there are four tabs: "Summary" (selected), "Memory", "Networking", and "Replication".

Figure 2-13: VM version number

Note Do not confuse version with generation. Both Generation 1 and Generation 2 can be version 5.0. The version number has to do with the version of Windows Server that was used to create the VM, whereas the generation has to

do with what virtualized hardware is available to the VM.

It is also important to note that although you can live-migrate VMs outside of failover clustering, you will most likely use this new mobility within failover clustering. For the first time since Windows Server 2003, failover clustering now supports mixed mode clusters. This means that you can upgrade Windows Server 2012 R2 cluster nodes to the new Windows Server 2016 while retaining their cluster membership. And with the improvements to mobility, you can move VMs effortlessly between older and newer cluster nodes as part of the overall cluster upgrade strategy.

VM configuration version

The VM upgrade process has changed in Windows Server 2016. In the past, when you imported VMs to a new version of Hyper-V, they were automatically upgraded. However, it was not always easy to identify which VMs were imported from a previous version of Hyper-V and which were newly created. That's because the VM configuration version upgrades automatically with the host upgrade.

The real challenge, however, was that you couldn't roll back the VM to a previous configuration version. The VM version determines with which versions of Hyper-V the VM's configuration, saved state, and snapshot files are compatible. In Windows Server 2016, the VM configuration version upgrade process is no longer automatic. This makes it possible for you to move the VM to a server running an earlier version of Hyper-V, such as Windows Server 2012 R2. In that case, you do not have access to new VM features until you manually update the VM configuration version.

All VM capabilities remain compatible, such as live migration, storage live migration, and dynamic memory. Hence, upgrading a VM is now a manual operation that is separate from upgrading the physical host. It is important to note that when you upgrade the configuration version of the VM, you cannot downgrade it. If you use VMs that were created with Windows Server 2012 R2, you will not have access to new VM features until you manually update the VM configuration version.

VMs with configuration version 5.0 are compatible with Windows Server 2012 R2 and can run on both Windows Server 2012 R2 and Windows Server 2016. VMs with configuration

version 6.0 are compatible with Windows Server 2016 but will not run on Hyper-V running on Windows Server 2012 R2.

The following table lists the supported versions of the configuration version on Windows:

Hyper-V host Windows version	Supported VM configuration versions
Windows 10 Anniversary Update	8.0, 7.1, 7.0, 6.2, 5.0
Windows Server 2016 Technical Preview	7.1, 7.0, 6.2, 5.0
Windows 10 build 10565 or later	7.0, 6.2, 5.0
Windows 10 builds earlier than 10565	6.2, 5.0
Windows Server 2012 R2	5.0
Windows 8.1	5.0

Upgrading the configuration version

To upgrade the configuration version, shut down the VM and, at an elevated Windows PowerShell command prompt, type the following command:

```
Update-VmConfigurationVersion vmname or vmobject.
```

To check the configuration version of the VMs running on Hyper-V, from an elevated command prompt, run the following command:

```
Get-VM * | Format-Table Name, Version
```

To illustrate the configuration version upgrade process, the following example determines the VM configuration version imported from a host running Windows Server 2012 R2 and then shows how to upgrade its configuration version. In this case, as expected, the configuration version of the VM is 5.0 as indicated in Hyper-V Manager (see Figure 2-14).



Created: 11/4/2014 3:44:13 AM	Clustered: No
Version: 5.0	Heartbeat: OK (Applications Healthy)
Generation: 2	

Figure 2-14: VM version number

You can confirm this by using Windows PowerShell as follows:

```
PS C:\Users\Administrator> Get-VM vm02 | Format-Table Name, Version
Name                                     Version
----                                     -
vm02                                     5.0
```

As stated previously, you must shut down the VM and run the following Windows PowerShell command to upgrade the configuration version of the VM:

```

PS C:\Users\Administrator> Update-
VMConfigurationVersion vm02
Confirm
Are you sure you want to perform this action?
Performing a configuration version update of "vm02"
will prevent it from being migrated to or imported
on previous versions of Windows. This operation is
not reversible.
[Y] Yes [A] Yes to All [N] No [L] No to All [S]
Suspend [?] Help (default is "Y"): Y
PS C:\Users\Administrator>

```

When checked again, the configuration version in Hyper-V Manager now has the value 6.0, as depicted in Figure 2-15.



Figure 2-15: Upgraded version number

Again, you can confirm this by using Windows PowerShell, as follows:

```

PS C:\Users\Administrator> Get-VM vm02 |Format-Table
Name, Version
Name                                     Version
----                                     -
vm02                                     6.0

```

As an aside, if you get any startup failure after a VM configuration version upgrade, try turning on secure boot and then run the following Windows PowerShell command:

```

Set-VMFirmware -VMName "VMName" -SecureBootTemplate
MicrosoftWindows

```

The VM configuration version is successfully upgraded, which means that the VM has access to new VM features introduced in Windows Server 2016.

Upgrade process considerations

You need to be aware of several considerations before you upgrade the configuration version of a VM:

- You must shut down the VM before you upgrade the VM configuration version.
- The configuration version upgrade process is one way; that is, when you upgrade the configuration version of the VM from version 5.0 to version 6.0, you cannot downgrade, and, hence, afterward you cannot move the VM to a server running Windows Server 2012 R2.
- The `Update-VMConfigurationVersion` cmdlet is blocked on a Hyper-V cluster when the cluster functional level is Windows Server 2012 R2. You can still move the VM between all of the nodes in the Hyper-V cluster, however, when the cluster has a mix of both Windows Server 2012 R2 and Windows Server 2016.

More info To read more about the upgrade process, go to <https://technet.microsoft.com/en-us/windows-server-docs/compute/hyper-v/deploy/upgrade-virtual-machine-version-in-hyper-v-on-windows-or-windows-server>.

New configuration file format

After you have upgraded the VM configuration version as described in the previous section, the VM will use the new configuration file format. The new VM configuration file format uses the `.vmcx` extension for the VM's configuration data and the `.vmrs` extension for its runtime state data. The new format is a binary file format, which means that you cannot edit the file directly. The new configuration file format increases the efficiency of reading and writing the VM's configuration data, reduces the potential for data corruption in the event of a storage failure, and provides better overall efficiency.

Figure 2-16 shows the new VM configuration file format, which uses the `.vmcx` extension for the VM's configuration data and the `.vmrs` extension for runtime state data.

Name	Date modified	Type	Size
📁 EAF3B45D-6929-43A2-82E1-05A65F31A6CC	11/4/2014 3:48 AM	File folder	
📄 EAF3B45D-6929-43A2-82E1-05A65F31A6CC.vmcx	11/6/2014 2:49 AM	VMCX File	95 KB
📄 EAF3B45D-6929-43A2-82E1-05A65F31A6CC.VMRS	11/6/2014 2:49 AM	VMRS File	4,194,380 KB

Figure 2-16: VM configuration files

You can determine a VM's configuration location and related information by using Windows PowerShell to examine the properties of the VM:

```
PS C:\Users\Administrator> Get-VM -Name vm02
|Format-List *
```

VMName	:	vm02
VMId	:	
eaf3b45d-6929-43a2-82e1-05a65f31a6cc	:	
Id	:	
eaf3b45d-6929-43a2-82e1-05a65f31a6cc	:	
Name	:	vm02
State	:	Running
IntegrationServicesState	:	Update
required	:	
OperationalStatus	:	{Ok}
PrimaryOperationalStatus	:	Ok
SecondaryOperationalStatus	:	
StatusDescriptions	:	
{Operating normally}	:	
PrimaryStatusDescription	:	
Operating normally	:	
SecondaryStatusDescription	:	
Status	:	
Operating normally	:	
Heartbeat	:	
OkApplicationsHealthy	:	
ReplicationState	:	
Disabled	:	
ReplicationHealth	:	
NotApplicable	:	
ReplicationMode	:	None
CPUUsage	:	0
MemoryAssigned	:	
4294967296	:	
MemoryDemand	:	

```

600834048
MemoryStatus :
SmartPagingFileInUse : False
Uptime :
22:37:12
IntegrationServicesVersion :
6.3.9600.16384
ResourceMeteringEnabled : False
AutomaticCriticalErrorAction : Pause
AutomaticCriticalErrorActionTimeout : 30
ConfigurationLocation :
c:\vmdata\vm02\vm02
SnapshotFileLocation :
c:\vmdata\vm02\vm02
CheckpointType :
Production
AutomaticStartAction :
StartIfRunning
AutomaticStopAction : Save
AutomaticStartDelay : 0
SmartPagingFilePath :
c:\vmdata\vm02\vm02
NumaAligned : True
NumaNodesCount : 1
NumaSocketCount : 1
Key :
Microsoft.HyperV.PowerShell.VirtualMachineObjectKey
IsDeleted : False
ComputerName :
SIGGPB04-T1
Version : 6.0
Notes :
Generation : 2
Path :
c:\vmdata\vm02\vm02
CreationTime :
11/4/2014 3:44:13 AM
IsClustered : False
SizeOfSystemFiles : 97132
ParentSnapshotId :
ParentSnapshotName :
MemoryStartup :
4294967296
DynamicMemoryEnabled : False
MemoryMinimum :

```

```
536870912
MemoryMaximum :
1099511627776
ProcessorCount : 1
RemoteFxAdapter :
NetworkAdapters :
{Network Adapter}
FibreChannelHostBusAdapters : {}
ComPort1 :
Microsoft.HyperV.PowerShell.VMComPort
ComPort2 :
Microsoft.HyperV.PowerShell.VMComPort
FloppyDrive :
DVDDrives : {}
HardDrives : {Hard
Drive on SCSI controller number 0 at location 0}
VMIntegrationService : {Time
Synchronization, Heartbeat, Key-Value Pair Exchange,
Shutdown...}
```

Production checkpoints

Windows Server 2016 introduces a new concept of taking checkpoints for production VMs; that is, production checkpoints. A *checkpoint* is a point-in-time capture of the state of a VM, which gives you the ability to revert the VM to an earlier state. Before Windows Server 2016, the use of checkpoints focused on test and development scenarios but was not recommended for use in production environments.

Production checkpoints deliver the same kind of experience as in Windows Server 2012 R2, but

they are now fully supported for production environments for two main reasons:

- The Volume Snapshot Service (VSS) is now used instead of saved state to create checkpoints.
- Restoring a checkpoint is just like restoring a system backup.

Note VSS is used for creating production checkpoints only on Windows VMs; Linux VMs do this by flushing their file system buffers to create a file system–consistent checkpoint.

If you want to create checkpoints by using saved-state technology, you can still use standard checkpoints for your VM. However, the default for new VMs will be to create production checkpoints with a fallback to standard checkpoints.

In certain scenarios, an administrator might need to disable checkpoints for specific VMs for operational reasons. This is now feasible in Windows Server 2016, which gives you the ability to turn on or turn off production checkpoints on individual VMs. This option provides flexibility and gives Hyper-V administrators the means to manage and optimize their resources effectively.

Figure 2-17 demonstrates how you can use VM settings to turn on or turn off checkpoints for the VM and allow production checkpoints. By default, the Enable Checkpoints option is selected and is configured to allow production checkpoints and to create standard checkpoints if it is not possible to create a production checkpoint.

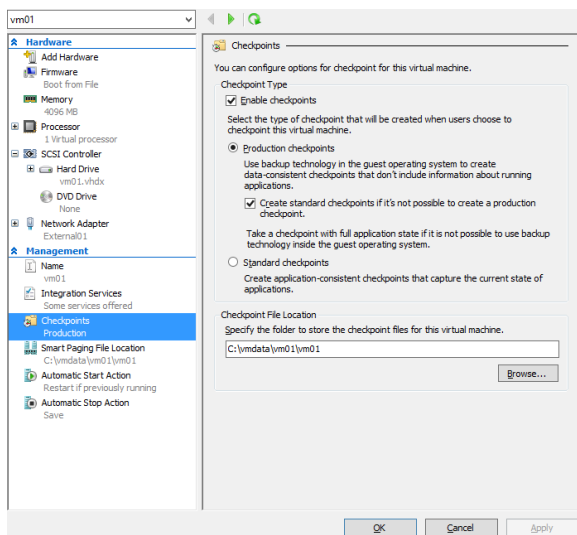

Figure 2-17: Configuring production checkpoints on a VM

To create a new production checkpoint for a VM, turn on checkpoints for that VM, right-click the

VM in Hyper-V Manager, and then, on the shortcut menu that appears, click Checkpoint, as shown in Figure 2-18.

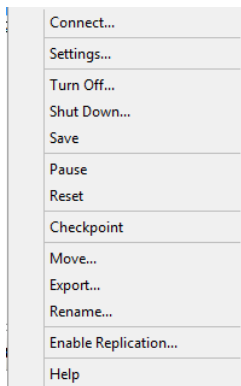

Figure 2-18: The menu option for creating a new production checkpoint for a VM

Note If you turn off production checkpoints for a VM, the Checkpoint option will not appear in the shortcut menu for the VM.

When a production checkpoint is created, the message shown in Figure 2-19 appears, which confirms that the production checkpoint has been successfully taken.

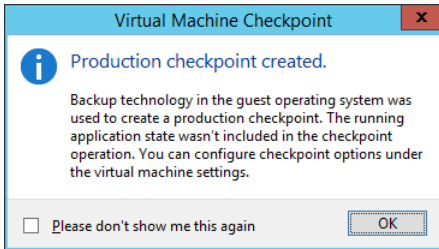

Figure 2-19: Message indicating that the production checkpoint was successfully created

And, of course, you also can do all of this by using Windows PowerShell.

Hot add and hot remove for network adapters and memory

With Windows Server 2016, you no longer need to plan for downtime to upgrade or downgrade memory on VMs hosted on Hyper-V. There is also no downtime when adding or removing a network card. Now, you can hot-add and hot-remove both network adapters and memory on the platform. This is a huge improvement that will ease the Hyper-V administrator's job. In a physical environment, installing additional RAM or adding a new network card is a time-consuming process that usually involves planning and downtime. With this new feature, you can accomplish everything with no

downtime. Both service providers and enterprises can now scale up or scale down the memory of VMs in seconds by using either Hyper-V Manager or Windows PowerShell.

Note Hot-add memory works for Generation 1 and Generation 2 guests running Windows Server 2016. It does not work with Windows Server 2012 R2 or earlier.

Hot add and remove memory

Figure 2-20 presents Hyper-V Manager with two VMs named VM1 and VM2 running on it. Hyper-V Manager shows that VM2 is a Generation 1 VM, and the Settings dialog box for VM2 shows that this VM has been provisioned with 2 GB (2,048 MB) of RAM.

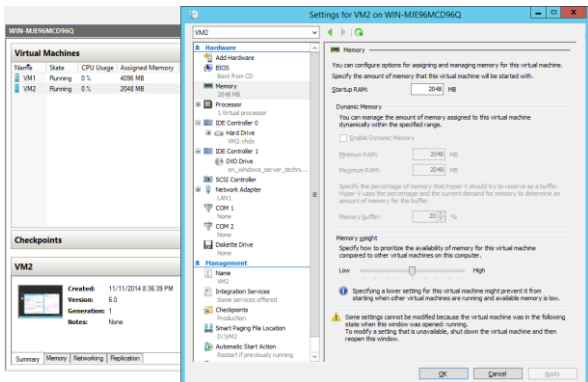

Figure 2-20: Generation 1 settings for memory

Connecting to this VM using Virtual Machine Connection shows that two applications are currently running on its desktop: Date and Time, which displays a clock with the current time, and Task Manager, which displays the memory usage of VM2 and shows that 2 GB are available, as shown in Figure 2-21.

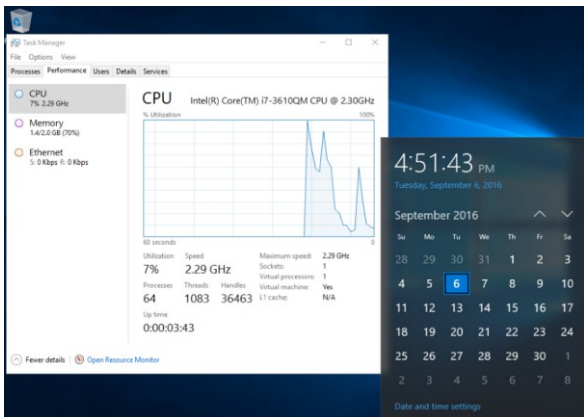

Figure 2-21: VM task manager showing memory usage

Use the settings for VM2 to change the RAM used by this VM from 2 GB to 4 GB and then click Apply while the VM is still running. Within a few seconds, Hyper-V Manager shows that VM2 is now running with 4 GB of RAM, with no reboot necessary, as illustrated in Figure 2-22.

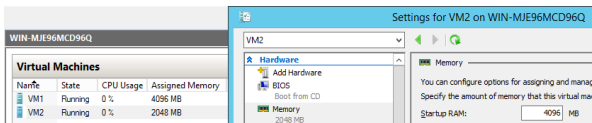

Figure 2-22 VM memory settings changing while running

Virtual Machine Connection shows that the clock is still running in VM2, and Task Manager

displays 4 GB of memory available to the VM, using the hot-add memory feature of Windows Server 2016, as shown in Figure 2-23.

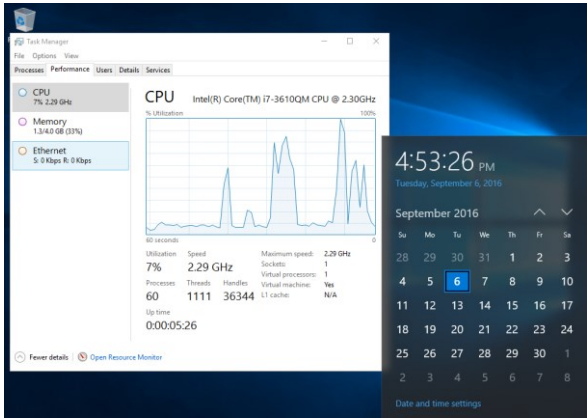

Figure 2-23: VM Task Manager showing the VM with new memory

Hot add and remove network adapters

Adding or removing a network adapter while the VM is running without incurring downtime works only for Generation 2 VMs running either Windows or Linux. Supported Windows operating systems include Windows Server 2016.

In the following example, connecting to the Generation 2 VM named VM1 using Virtual Machine Connection and opening the Network

Connections folder shows that this VM has only a single network connection named Ethernet 2, as depicted in Figure 2-24.

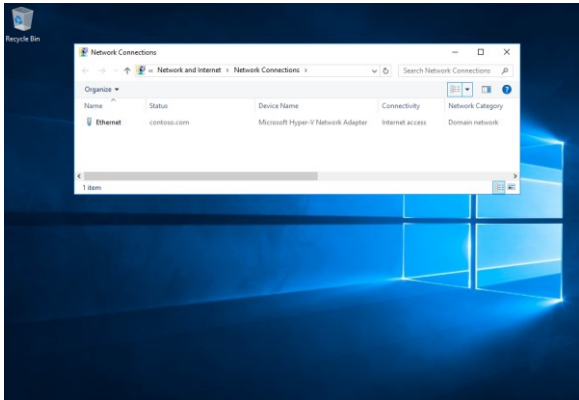

Figure 2-24: Single VM NIC

To hot-add another network adapter to this VM, in the Settings dialog box, on the Add Hardware page, select Network Adapter, as shown for VM1 in Figure 2-25.

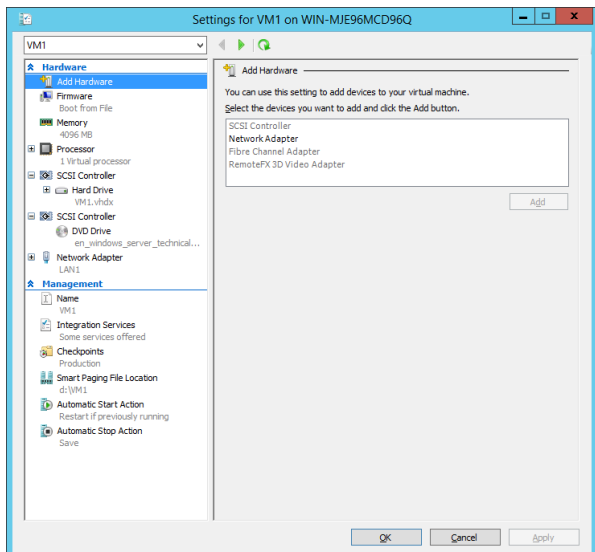

Figure 2-25: Adding a NIC to a VM

Note If the Network Adapter option is unavailable on the Add Hardware page of the Settings dialog box, it is because the VM is Generation 1, which does not support hot add and remove network adapter functionality.

Click Apply for the changes to take effect. After a few seconds, the new network adapter is installed while the VM is still running, as shown in the Network Connections folder in Virtual Machine Connection. Figure 2-26, demonstrates

that the hot-add of the network adapter is successful.

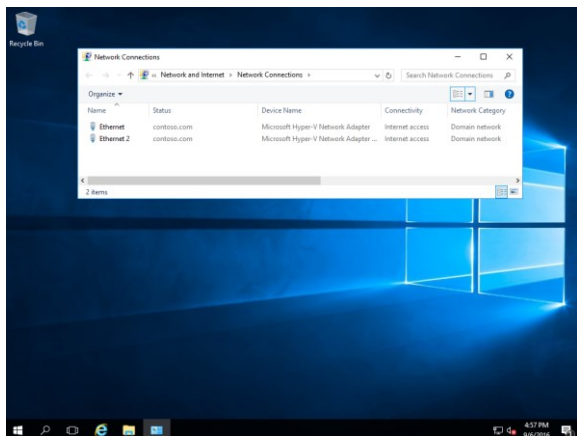

Figure 2-26: VM displaying the newly added NIC

Failover cluster

By John Marlin and Colin Robinson

This section describes key improvements Microsoft has made to failover clustering in Windows Server 2016. These improvements include the following:

- Cloud witness using Microsoft Azure
- Shared VHDX improvements

- Improved cluster logs
- Active memory dumps
- Network name diagnostics
- Cluster operating system rolling upgrade
- Workgroup and multidomain clusters
- SMB multichannel and multi-NIC cluster networks
- VM improvements

In addition, Colin Robinson walks us through a detailed demonstration of performing a rolling upgrade on a failover cluster.

Creating a cloud witness by using Azure

Beginning with Windows Server 2008, each version of failover clustering introduced a new quorum type to complement what already exists. That hasn't changed. Windows Server 2016 introduces the cloud witness quorum type, a witness that you can create in the cloud by using Azure.

This quorum type takes advantage of the Azure public cloud as the arbitration (witness) point for

the cluster. You can achieve this configuration without the need for an extra site and you will utilize it mostly in multisite clusters. It provides a quorum option for the following situations:

- Multisite clusters that do not have a third site on which to place a file-share witness
- Clusters using nonshared storage
- Guest clusters hosted in Azure
- Guest clusters hosted in private clouds
- Clusters using Direct-Attached Storage (DAS)

The cloud witness acts the same as a file-share witness, using the same basic logic in that it does not contain a copy of the cluster database and will act as a deciding vote to prevent *split brains* (multiple nodes running in the same cluster that cannot communicate with one another).

To configure a cloud witness, you first must have an Azure subscription. Here are the steps you need to take to get one:

1. Sign in to the Azure management portal (<https://portal.azure.com>) and create a storage account for this witness (if you are not sure how to see

<https://azure.microsoft.com/documentation/articles/storage-create-storage-account/>

2. When the storage account is created, highlight it in the portal, and then click Manage Access Keys. Copy the primary access key for later use.
3. In the Failover Cluster Manager console, configure the quorum for the cloud witness. First, right-click the name of the cluster, and then, on the shortcut menu that opens, click More Actions, and then select Configure Cluster Quorum Settings, as demonstrated in Figure 2-27.

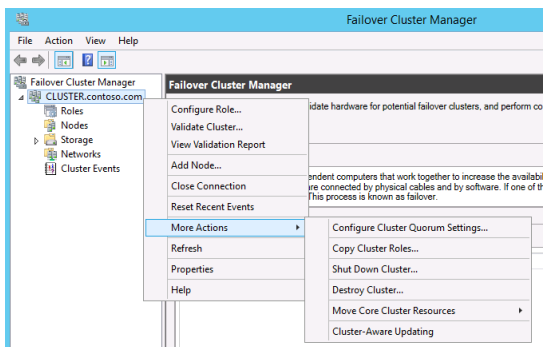

Figure 2-27: Configuring cluster quorum settings

4. The Configure Cluster Quorum Wizard opens. On the Select Quorum Configuration

Option page, click **Select The Quorum Witness**, as depicted in Figure 2-3

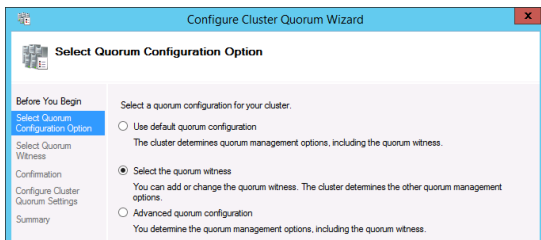

Figure 2-28: Selecting the quorum type

5. On the **Select Quorum Witness** page, click **Configure A Cloud Witness**, as illustrated in Figure 2-29.

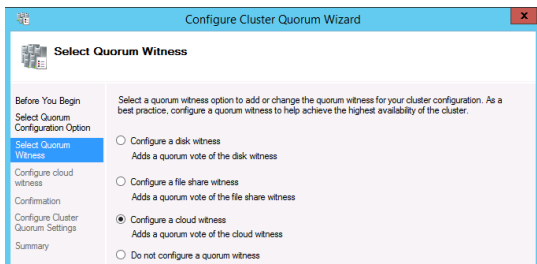

Figure 2-29: Configuring a cloud witness

6. On the **Configure Cloud Witness** page, type the storage account name you created in the management portal, your Azure primary

storage account key, and the Azure service endpoint, as shown in Figure 2-30.

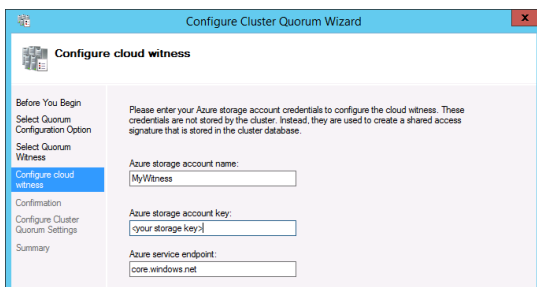

Figure 2-30: Entering storage account information

Note You can do the same in Windows PowerShell by using the following command:

```
Set-ClusterQuorum -CloudWitness -  
AccountName MyWitness -AccessKey <your  
storage key>  
-Endpoint core.windows.net
```

There are two key prerequisites for using the cloud witness:

- You must have a valid Azure subscription.
- All nodes must have Internet access and be able to access Azure.

Additionally, as with a file-share witness, you can use the same Azure account or container for multiple clusters.

Shared VHDX improvements

Since Windows Server 2008 Hyper-V, you have had the ability to create guest clusters as VMs. However, to have any sort of shared storage, you were required to use iSCSI. Windows Server 2012 introduced virtual Fibre Channel support for VMs as a second option for shared storage.

However, from a service provider perspective, virtual Fibre Channel is not always a viable option. Virtual Fibre Channel opens and allows customer access to the physical storage infrastructure as does physical iSCSI. However, if a service provider set up a VM and added iSCSI support for the customer-shared drives, the customers might be unhappy because they would be charged for an additional VM.

Because of these concerns, Microsoft introduced Shared VHDX in Windows Server 2012 R2 as an additional option. Shared VHDX gives guest clusters the shared storage they needed without access to storage infrastructures. This did add another option from a shared-disk perspective; however, it was not without limitations. In the

latest Windows Server 2016, improvements have been made to address some of these limitations.

Suppose that you have a Shared VHDX drive that is filling up, and you need to increase the size. In Windows Server 2012 R2, downtime was unavoidable because to increase the size the VMs would need to be powered off. That is not an ideal solution for a 24/7 business. In Windows Server 2016, you can now expand the drive while it is online. (Note that you can only expand a Shared VHDX drive, you cannot shrink one.)

To expand the drive, perform the following steps:

1. Open Failover Cluster Manager, right-click a VM, and then select Settings.
2. Click the drive that you want to expand, as depicted in Figure 2-31.

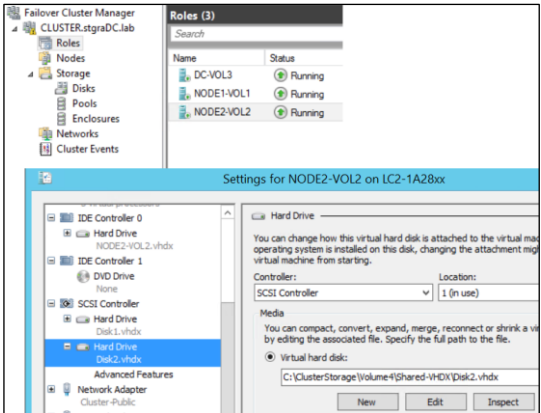

Figure 2-31: Settings for Hard Drive

- Click Edit to start the Edit Virtual Hard Disk Wizard. The only available option is Expand, so the selection is already made for you, as illustrated in Figure 2-32.

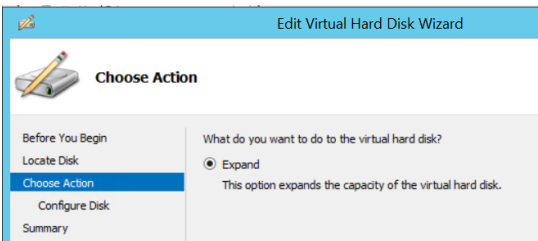

Figure 2-32: Expanding a hard drive

4. On the Configure Disk page, type the size you want the virtual hard drive to be, as shown in Figure 2-33.

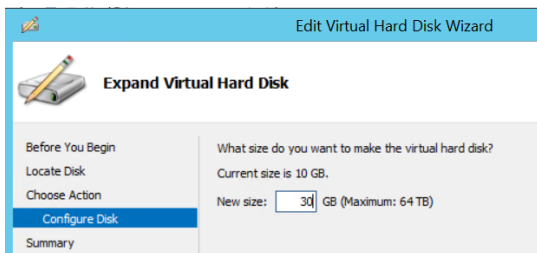

Figure 2-33: Type the size for expansion

Note You can do the same by using the following Windows PowerShell cmdlet:

```
Resize-VHD -Path  
C:\ClusterStorage\Volume4\Shared-  
VHDX\Disk2.vhdx -SizeBytes 32212254720
```

5. When you have completed the wizard, open the VM and expand the drive in Server Manager, as demonstrated in Figure 2-34.

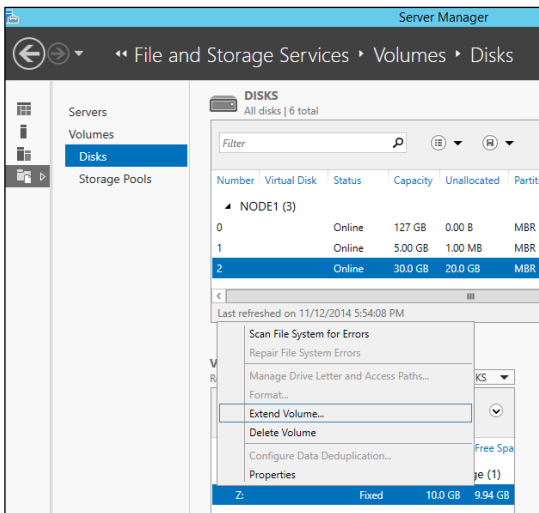

Figure 2-34: Extending a volume in Server manager

With your VMs all running on your Hyper-V cluster, it is time to back up the machines. In Windows Server 2012 R2, you cannot back up the Shared VHDX attached to a VM from the host. Because it is shared, it is blocked from being backed up. However, in Windows Server 2016, you can select it as a virtual hard drive (VHD) to back up.

VMs that include a Shared VHDX can now also participate in Hyper-V Replica. In previous

versions of Windows Server, VMs with a Shared VHDX were blocked from participating. With the improvements in Shared VHDX, you not only have the option to replicate the VMs, you also have the option to select any or all of the Shared VHDX drives, as presented in Figure 2-35.

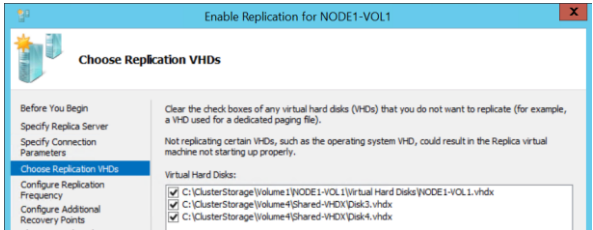

Figure 2-35: Choosing replica VHDs

Improved cluster logs

Getting as much critical data as possible in a timely fashion can help to quickly resolve failover clustering problems. Getting the right data at the right time can be critical for restoring services. With all the Service-Level Agreements (SLAs) available, the right diagnostics is crucial to many businesses.

From a diagnostic standpoint, the first improvement in Windows Server 2016 is with the cluster diagnostics log. The cluster log has always been useful for identifying an error, what

led to an error, what was happening at the time of the error, and so on. But using the cluster log to determine things such as the configuration of the cluster is a more involved process.

For example, if you want to know the resources in the cluster, as long as the cluster log shows the cluster service starting, the required information is there, but finding it requires searching through many lines to piece it all together, as demonstrated in the following example:

```
<Networks><vector len='4'>
<item><obj sig='NETW' id='1f509983-2478-4630-af8a-
e13d2c486172' name='Cluster Network 2'/></item>
<item><obj sig='NETW' id='967df8d8-0f94-4d02-93d5-
046fa1ce2369' name='Cluster Network 1'/></item>
<item><obj sig='NETW' id='99e6e621-0de5-4a1c-a468-
a68057ee6278' name='Cluster Network 4'/></item>
<item><obj sig='NETW' id='a171b564-6b89-4c7d-91a5-
f2dcbe450fbe' name='Cluster Network 3'/></item>
</vector>
```

```
<LIVE id='.Live' name='.Live'>
<NODE id='2' name='2012R2N1'>
<ITFC id='62edcfaa-fb25-4108-ac2b-236b3520af3f'
name='2012R2N1 - WAN'/>
<ITFC id='884676e9-6df6-4a26-a423-c9b113a99056'
name='2012R2N1 - iSCSI 2'/>
<ITFC id='65fa8c93-c242-45f0-88ab-9e26f0845c0b'
name='2012R2N1 - Public'/>
<ITFC id='10962cca-3015-4380-8011-76e47ef575c4'
name='2012R2N1 - iSCSI 1'/>
</NODE>
<NODE id='1' name='2012R2N2'>
<ITFC id='9e79c4c8-8d78-4d14-ab51-7a39d7191c4a'
name='2012R2N2 - WAN'/>
<ITFC id='09569c99-262d-4f6b-95e4-f69185669f2b'
```

```
name='2012R2N2 - iSCSI2' />
<ITFC id='aa8f05e2-eeae-452c-9960-3905d0319fe1'
name='2012R2N2 - Public' />
<ITFC id='95d0074f-6ff6-4b5f-89a7-454fe2306332'
name='2012R2N2 - iSCSI1' />
</NODE>
</LIVE>
```

Getting just this little bit of information entails going through 1,000 or more lines in the logs; a time-consuming task, to be certain. Looking up other specific information about the configuration can take you back through these same sets of entries, plus more.

You can get this type of information from other logs or the registry, but that requires reviewing information from multiple files. If you are not at the machine and someone else gathers logs for you, that person might not include all of the logs. This can delay things further as you wait to get the proper information.

This complexity was an important consideration for Windows Server 2016 as it relates to failover clustering. Because of this, the cluster diagnostics log has been redesigned. When you generate a cluster log in Windows Server 2016, it includes additional information that you can access quickly, broken down into various sections, as illustrated here:

```
[=== Cluster ===]
This section gives information about the version,
```

time running, node name the log came from, etc

[=== Resources ===]

List of all resources (including the GUID) and the configurations/parameters of those resources

[=== Groups ===]

List of all groups (including the GUID) and the configurations/parameters of those groups, owner node, etc

[=== Resource Types ===]

List of all resource types (including the GUID) and the configurations/parameters of those resource types

[=== Nodes ===]

This section gives information about the nodes including the version, time running, node id, etc

[=== Networks ===]

This section gives information about the networks including the role, the network scheme, metric, if RSS capable, etc

[=== Network Interfaces ===]

This section gives information about the networks including the name, IP Address information, etc

[=== System ===]

All System Event Log entries with Failover Clustering as the source

[=== Microsoft-Windows-

FailoverClustering/Operational logs ===]

All events from the Microsoft-Windows-FailoverClustering/Operational channel that gives you information about the forms of a cluster, node joins, group moves, etc

[=== Microsoft-Windows-ClusterAwareUpdating-Management/Admin logs ===]

All events from the Microsoft-Windows-ClusterAwareUpdating-Management/Admin channel that gives you information about Cluster Aware Updating

```
[=== Microsoft-Windows-ClusterAwareUpdating/Admin logs ===]
```

All events from the Microsoft-Windows-ClusterAwareUpdating/Admin channel that gives you information about Cluster Aware Updating

```
[=== Microsoft-Windows-FailoverClustering/DiagnosticVerbose ===]
```

This is actually a new event channel that gives you the similar output as Debug Level 5 for a Cluster Log without having to set it. You can use this information to get deeper into the calls and goings on with the cluster and gives it in a more verbose output.

```
[=== Cluster Logs ===]
```

This is the output that you normally see in a cluster log.

Clearly, there is a lot to this log now. Using this one log can reduce the time you spend looking for information or trying to resolve an issue. Instead of having to review three or more files that might be loaded in three different applications with their own formats, you now need only review one file.

The other useful thing about the log is that if you generate it with no switches, everything in an event channel (for example, the System Event) is shown. So you can actually get any history pertaining to a particular problem. For cases in which you can reproduce an error condition and do not need all of the history, you can generate a log for the last five minutes (`TimeSpan=5`). Helpfully, the new cluster log uses this same five-

minute time span for all of the event channels and gives you only those, so you don't need to deal with an unnecessarily large file.

Active memory dump

Another new feature as it relates to diagnostics is the ability to capture memory dumps. Imagine that you have a big Hyper-V cluster and each of the nodes has 512 GB of memory. If the node is having an issue and you create a memory dump that contains both user and kernel mode memory, that memory dump is going to be larger than 512 GB. Trying to work with a file that size can be a nightmare. First, you need to ensure that you have a drive with enough free space to hold a file of that size. You then need to spend hours zipping, uploading, and unzipping before you can even begin to open it. If the problem is with the host server itself and you are running VMs that use 500 GB of that memory, this is information that you don't need, because it does not pertain to the host.

Because of this, there is a new dump setting called Active Memory Dump. This setting captures only the memory that the host is actually using. If the host is actively using only 5 GB of memory, a 5 GB memory dump is what will be created. This smaller dump is much easier to

parse than the 512 GB file in the previous scenario.

The Active Memory Dump option is in the same location as the normal dump settings, in the Startup And Recovery dialog box of the System Properties, as shown in Figure 2-36.

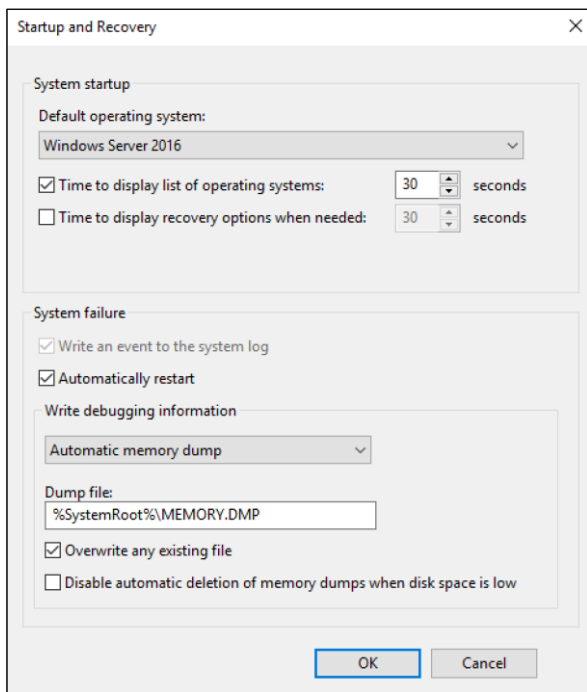

Figure 2-36: Active Memory Dump settings

Note On the topic of memory dumps in general, failover clustering has been integrated with Live Dump to capture dumps when timeouts are reached. You then can analyze these dumps for root cause. This also integrates with Windows Error Reporting to allow for retention and inclusion of other logs.

Depending on how a resource times out and how failover clustering is configured, Live Dump can trigger the machine to issue a stop error (i.e., blue screen) and cause the machine to crash in order to create a memory dump. Although the memory dump is useful in determining the cause of a problem, it does incur downtime while the machine reboots to create the dump. However, with the integration of Live Dump, a memory dump is created in the background while the machine itself continues to run, which does not affect production.

The focus of this feature is to collect enough logs/dumps for Microsoft support to more successfully troubleshoot various issues that customers might experience when using clusters. The goal is to gather enough information so that support can help solve the problem when customers call, instead of asking customers to reproduce the problem and then waiting for a time when it can be done.

Network name diagnostics

Windows Server 2016 features improvements related to diagnosing network name problems. At times, some of the events are confusing or not even present. For example, previously, problems updating DNS resulted in a generic error indicating that DNS could not be updated. But the error notification did not indicate why DNS could not be updated. There can be several reasons for this:

- DNS does not accept dynamic updates.
- You are using a secure DNS server, and the cluster does not have the proper rights.
- There are timeouts getting to the DNS server.

Troubleshooting an event such as this took time because you had to look at it in broad terms before you could focus on a specific area and narrow down the problem. In Windows Server 2016, events are updated to include the specific error. So, if the error is due to one of the reasons mentioned in the list, you are notified of the error and can immediately focus on that one cause. This makes for quicker resolutions because you do not need to troubleshoot a problem that does not exist.

Also, additional checks have been added for the network name to help prevent a problem that might not occur for days or weeks. During every online/offline of the resource and every one hour that the name is online, Windows Server 2016 checks for the following:

- A searchable domain controller
- A synchronized Cluster Name Object (CNO) password
- A CNO in Active Directory that is turned on
- An existing CNO and Virtual Computer Object (VCO) in Active Directory

Windows Server 2016 also includes several additional tests in cluster validation for network names to do the following:

- Check that the CNO and VCO are greater than 15 characters
- Verify that the CNO has Create Computer Object permissions in the Organizational Unit (OU) in the Active Directory of which it is a member
- Ensure that it is possible to sign in to the CNO and corresponding VCO

- Confirm that the local Users group on the nodes has the members CLISUR and NT AUTHORITY\Authenticated Users

The previous items are commonly the cause of issues with network names, which is why these new diagnostics were added.

Cluster operating system rolling upgrade

Windows Server 2016 introduces a wonderful new method for upgrading the operating system of your server clusters with no downtime and dramatically reduced effort. This feature is called the *cluster operating system rolling upgrade*. Cluster operating system rolling upgrades initially will be limited to Hyper-V clusters and scale-out file servers (SOFS) clusters for Windows Server 2016.

Until now, the cluster administrator was tasked with developing a detailed migration plan to update clusters with a new operating system. Often, administrators waited to move a cluster until new hardware was brought in as part of a system refresh. This often meant several years without any new capabilities for the cluster as well as some planned downtime for moving services between the old and new cluster.

Cluster operating system rolling upgrade does not require the purchase of any additional hardware; the upgrades are done in place to each of the nodes. The cluster itself never needs to be stopped or restarted; the work takes place at the cluster node level, and all services remain online during the rolling upgrade process. Unlike typical cluster migration strategies, you do not need to make a new cluster. The existing cluster objects, including cluster name and cluster IPs, remain the same and online during the upgrade. Even better news is that you can fully reverse the process until the Cluster Functional Level attribute is changed. (More on that later.)

Figure 2-37 shows a three-node Hyper-V cluster named ContosoPVTCloud.

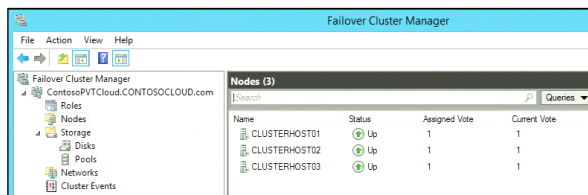

Figure 2-37: The Failover Cluster Manager console with a three-node cluster

Figure 2-38 and Figure 2-39 show three cluster shared volumes and a couple of VMs running.





Roles (2)				
Search <input type="text"/>				
Queries <input type="text"/>				
Name	Status	Type	Owner Node	Priority
 VDI_WIN81	 Running	Virtual Machine	CLUSTERHOST01	Medium
 Win2012R2_VM01	 Running	Virtual Machine	CLUSTERHOST01	Medium

Figure 2-38: Failover Cluster Manager console with two VMs running under Roles





Disks (4)			
Search <input type="text"/>			
Queries <input type="text"/>			
Name	Status	Assigned To	Owner Node
 Cluster Disk 1	 Online	Disk Witness in Quorum	CLUSTERHOST02
 Cluster Disk 2	 Online	Cluster Shared Volume	CLUSTERHOST02
 Cluster Disk 3	 Online	Cluster Shared Volume	CLUSTERHOST03
 Cluster Disk 4	 Online	Cluster Shared Volume	CLUSTERHOST03

Figure 2-39: Failover Cluster Manager console with three cluster shared volumes

As you would expect, you can move all services and roles between all nodes in the cluster. It is a fully functional and updated cluster. This is a good time to take backups, especially of the cluster itself if you choose to restore prior to completing the upgrade process.

At this point, you can begin the rolling operating system upgrades of the cluster. This is a test environment with few services running. In your environment, ensure that you have enough cluster resources to allow for one node at a time to be upgraded with the workloads supported by the remaining nodes active in the cluster.

Begin by evicting one of the nodes from the cluster to start the rolling upgrade process. You can pause and evict the node from within the Failover Cluster Manager or, in Windows PowerShell, you can run the `Suspend-ClusterNode` cmdlet, followed by the `Remove-ClusterNode` cmdlet. You can choose any node in the cluster to begin the rolling upgrade. This example begins with `ClusterHost01` of the `ContosoPVTCloud` cluster. First, right-click the node and then, on the shortcut menu, select `Pause` to suspend it, as illustrated in Figure 2-40.

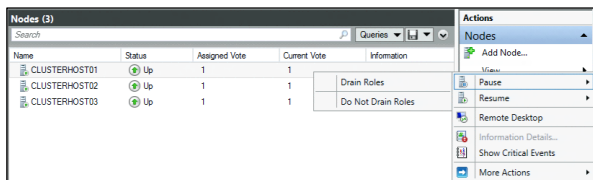

Figure 2-40: Pausing cluster node

Next, right-click the node and select `Evict` to evict it, as depicted in Figure 2-41.

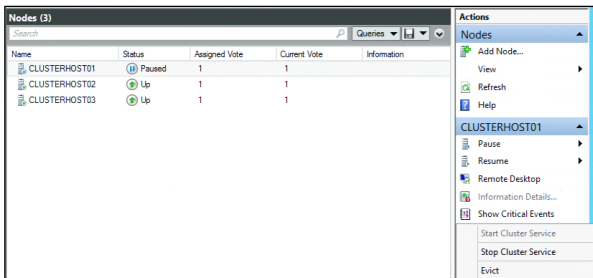

Figure 2-41: Evicting a cluster node

Next, you can begin to install a new operating system installation on that node.

Note You do not do an in-place operating system upgrade; you format and install a new operating system by using Windows Deployment Services, install from media, or other method of your choice to deploy the new operating system.

After Windows Server 2016 has been installed on ClusterHost01, install the Hyper-V role, failover clustering, and, if necessary, Multipath I/O. Configure the network and storage as it was configured prior to the reinstallation. This is a good time to check for any updates available for this version of Windows Server 2016. Join ClusterHost01 to the ContosoCloud domain that contains the cluster being upgraded.

Sign in to ClusterHost01 as a domain administrator of ContosoCloud domain or as another user with permissions on the current ContosoPVTCloud cluster. Start the Failover Cluster Manager and click Add Node, or run the Windows PowerShell Add-ClusterNode cmdlet. You must do this on the Windows Server 2016 server, not from a current cluster member running Windows Server 2012 R2.

The Failover Cluster Manager console on ClusterHost01 shows that it has successfully joined the cluster, as shown in Figure 2-42.

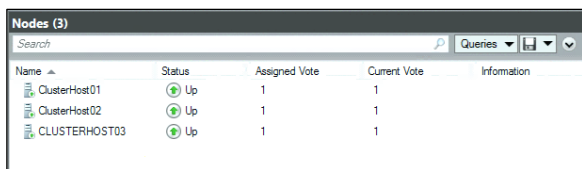

The screenshot shows the 'Nodes (3)' view in the Failover Cluster Manager console. It features a search bar, a 'Queries' dropdown, and a table with columns for Name, Status, Assigned Vote, Current Vote, and Information. Three nodes are listed: ClusterHost01, ClusterHost02, and CLUSTERHOST03, all with a status of 'Up' and an assigned vote of 1.

Name	Status	Assigned Vote	Current Vote	Information
ClusterHost01	Up	1	1	
ClusterHost02	Up	1	1	
CLUSTERHOST03	Up	1	1	

Figure 2-42: Cluster nodes successfully joined

Both VM roles have been moved to ClusterHost01, as demonstrated in Figure 2-43.

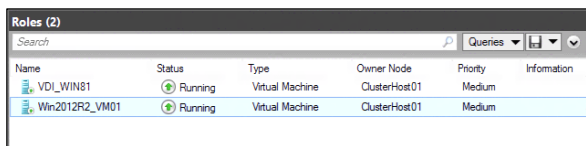

The screenshot shows the 'Roles (2)' view in the Failover Cluster Manager console. It features a search bar, a 'Queries' dropdown, and a table with columns for Name, Status, Type, Owner Node, Priority, and Information. Two roles are listed: VDI_WIN81 and Win2012R2_VM01, both with a status of 'Running' and an owner node of ClusterHost01.

Name	Status	Type	Owner Node	Priority	Information
VDI_WIN81	Running	Virtual Machine	ClusterHost01	Medium	
Win2012R2_VM01	Running	Virtual Machine	ClusterHost01	Medium	

Figure 2-43: VM roles have been moved to ClusterHost01

Observe that one of the cluster shared volumes and the quorum disk witness also has been moved to ClusterHost01, as shown in Figure 2-44.

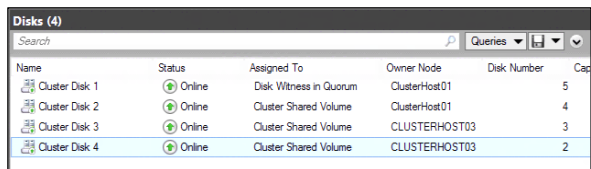

Name	Status	Assigned To	Owner Node	Disk Number	Cap
Cluster Disk 1	Online	Disk Witness in Quorum	ClusterHost01	5	
Cluster Disk 2	Online	Cluster Shared Volume	ClusterHost01	4	
Cluster Disk 3	Online	Cluster Shared Volume	CLUSTERHOST03	3	
Cluster Disk 4	Online	Cluster Shared Volume	CLUSTERHOST03	2	

Figure 2-44: Drives moved to ClusterHost01

You can move all roles and resources between any nodes in the cluster. This is not a one-way move to the new cluster. All nodes function in the cluster normally and can host any role or resource in the cluster during this mixed operating system phase of the rolling update.

While the cluster is mixed between Windows Server 2012 R2 and Windows Server 2016, you can patch and maintain all nodes normally until the rolling upgrade is completed. Backups can occur, but you should exclude them on the node being upgraded.

Continue the cluster operating system rolling upgrade by following the same process on ClusterHost02 and ClusterHost03. Again, drain and evict one node at a time, rebuild that node

with Windows Server 2016, and then rejoin to the domain and the cluster.

To perform the same steps by using Windows PowerShell, use the following examples:

1. Pause one of the nodes and drain off the roles, for example as follows:

```
PS C:\> Suspend-ClusterNode -Drain -TargetNode  
2012R2-NODE4
```

2. Evict the node from the cluster by using the following command:

```
PS C:\> Remove-ClusterNode -Name 2012R2-NODE4
```

3. Perform a clean installation of Windows Server to the node that was evicted.
4. Add the failover clustering feature by using the following command:

```
PS C:\> Install-WindowsFeature -ComputerName  
2012R2-NODE4 -Name Failover-Clustering -  
IncludeManagementTools -IncludeAllSubFeature
```

5. Add the Windows Server node to the Windows Server 2012 R2 cluster by using this command:

```
PS C:\> Add-ClusterNode -Cluster Cluster -Name  
Preview-Node5
```

```
PS C:\> Get-ClusterNode
```

Name	ID
State	
----	--

2012R2-NODE3	1
Up	
PREVIEW-NODE5	2
Up	

6. Reinstall roles, features, and software being used on the cluster (for example, Hyper-V, SQL, and so on).
7. Test failovers.
8. If everything proceeded properly, repeat steps 2 through 7 on the remaining node(s).

While some nodes are running Windows Server 2012 R2 and the others are running Windows Server 2016, you will be running in a mixed operating system mode. Associated with this mode is your cluster functional level. While you are in this mixed operating system mode of your cluster, running the following Windows PowerShell command from a Windows Server 2016 node returns a value of 8 for Windows Server 2012 R2 and a value of 9 for Windows Server 2016 nodes:

```
Get-ClusterNode | ft -auto NodeName, MajorVersion,
MinorVersion, BuildNumber, NodeHighestVersion,
@{Expression={$_.NodeHighestVersion -shr 16};
Label="NHV.Cluster Functional Level";width=21},
```

```
@{Expression={$_.NodeHighestVersion -band
0xffff};Label="NHV.Cluster Upgrade
Version";width=24},
```

```
NodeLowestVersion,
```

```
@{Expression={$_.NodeLowestVersion -shr 16};
Label="NLV.Cluster Functional Level";width=21},
```

```
@{Expression={$_.NodeLowestVersion -band
0xffff};Label="NLV.Cluster Upgrade
Version";width=24}
```

For example, Figure 2-45 shows the Windows PowerShell output with just one node remaining to be upgraded.

NodeName	NodeHighestVersion	NodeLowestVersion
ContosoPVTCloud	0	0

Figure 2-45: Nodes that can be upgraded

The output indicates the NodeHighestVersion and the NodeLowestVersion. When these two values match on all nodes, you can upgrade the cluster functional level by running the new Update-ClusterFunctionalLevel cmdlet, as presented in Figure 2-46.

```
PS C:\Users\administrator.CONTOSOCLLOUD>
PS C:\Users\administrator.CONTOSOCLLOUD> Update-ClusterFunctionalLevel

Updating the functional level for cluster ContosoPVTCloud.
Warning: You cannot undo this operation. Do you want to continue?
[Y] Yes [A] Yes to All [N] No [L] No to All [S] Suspend [?] Help (default is "Y"): Y

Name
----
ContosoPVTCloud

PS C:\Users\administrator.CONTOSOCLLOUD> _
```

Figure 2-46: Updating the functional cluster level

When all nodes in the cluster have been upgraded to Windows Server 2016, run the Windows PowerShell command again; this time you will get a value of 9, indicating that all nodes are upgraded, as depicted in Figure 2-47.

```
PS C:\Users\administrator.CONTOSO\CLOUD> Get-ClusterNode | Ft -auto NodeName, MajorVersion, MinorVersion, BuildNumber, NodeHighestVersion, @([Expression={$_.NodeHighestVersion -shr 16}; Label="NHV.Cluster Functional Level";width=21], >> @([Expression={$_.NodeHighestVersion -band 0xffff};Label="NHV.Cluster Upgrade Version";width=24], >> NodeLowestVersion, >> @([Expression={$_.NodeLowestVersion -shr 16}; Label="NLV.Cluster Functional Level";width=21], @([Expression={$_.NodeLowestVersion -band 0xffff};Label="NLV.Cluster Upgrade Version";width=24]) >> >>
```

NodeName	MajorVersion	MinorVersion	BuildNumber	NodeHighestVersion	NHV.Cluster Functional Level	NHV.Cluster Upgrade Version
ClusterHost01	6	4	9881	589827	9	3
ClusterHost02	6	4	9881	589827	9	3
ClusterHost03	6	4	9881	589827	9	3

Figure 2-47: All nodes upgraded

After this process is complete, your cluster operating system has been upgraded on all nodes and is fully functional for running Hyper-V and SOFS clusters. During this process, there was no downtime; all services were available. Because there are VMs and file shares that are configured with functionality from Windows Server 2012 R2, there are still a few steps on the cluster to get all of the functionality of Windows Server 2016.

If you look at the VMs in Hyper-V Manager, you can see that the version number of the VM is 5.0, as illustrated in Figure 2-48.

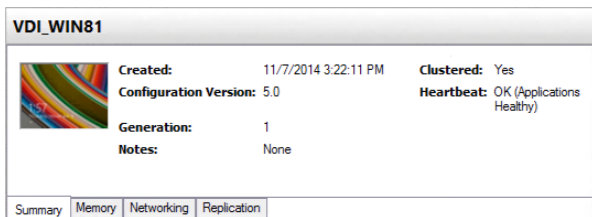

Figure 2-48: VM Version number

This indicates Windows Server 2012 R2 configuration for that VM. To upgrade the Hyper-V configuration version for each VM during your next maintenance window, you can run the Get-VM cmdlet followed by Update-VMConfigurationVersion, as shown in Figure 2-49.

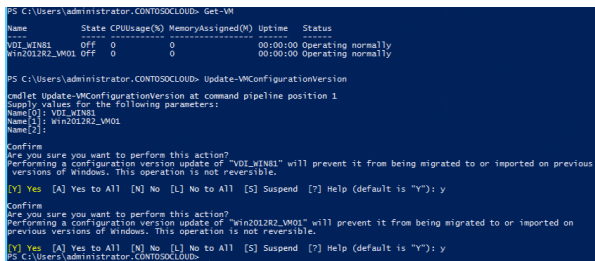

Figure 2-49: Updating VM Configuration

This will change the VM configuration version to 6.1 and turn on all new features available for Hyper-V in Windows Server 2016, as shown on

the Summary tab of the VM depicted in Figure 2-50.

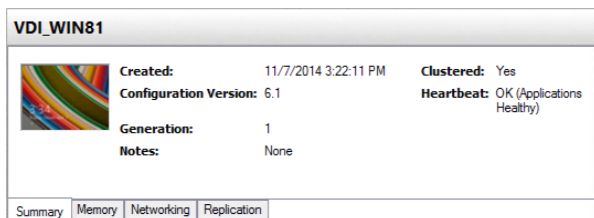

Figure 2-50: VM Configuration Version

For SOFS servers that have completed the cluster operating system rolling upgrade process, you will also want to upgrade the functionality of the storage pools. They will still be limited to the functionality in Windows Server 2012 R2 until you run the Update-StoragePool cmdlet. Specify the name of the storage pool that you want to update in this process.

When you have completed the cluster operating system rolling upgrade on all nodes, updated the cluster functional level, and updated the VM configuration version and storage pool to Windows Server 2016 functionality, you are all done!

Gone are the days when you needed to create a new cluster and recreate or move workloads. Cluster operating system rolling update

simplifies long-term cluster management and makes those complexities a thing of the past.

Workgroup and multidomain clusters

In Windows Server 2012 R2 and previous versions, you could create a cluster only between member nodes joined to the same domain. Windows Server 2016 breaks down these barriers and introduces the ability to create a failover cluster without Active Directory dependencies.

You can now create failover clusters in the following configurations:

- **Single-domain clusters** Clusters with all nodes joined to the same domain.
- **Multi-domain clusters** Clusters with nodes that are members of different domains.
- **Workgroup clusters** Clusters with nodes that are member servers/workgroup (not domain joined).

More info To read more about workgroup and multidomain clusters, got to

<https://blogs.msdn.microsoft.com/clustering/2015/08/17/workgroup-and-multi-domain-clusters-in-windows-server-2016/>.

SMB multichannel and multi-NIC cluster networks

Failover cluster networks are no longer limited to a single NIC per subnet/network. With simplified Server Message Block (SMB) multichannel and multi-NIC cluster networks, network configuration is automatic, and every NIC on the subnet can be used for cluster and workload traffic. This enhancement allows customers to maximize network throughput for Hyper-V, SQL Server Failover Cluster Instance, and other SMB workloads.

More info To learn more about SMB multichannel and multi-NIC cluster networks, go to <https://technet.microsoft.com/windows-server-docs/compute/failover-clustering/simplified-smb-multichannel-and-multi-nic-cluster-networks>.

VM improvements

There are three main areas of improvement for VMs on failover cluster

- VM node fairness

VM node fairness facilitates the seamless load balancing of VMs across the nodes in a cluster. Overcommitted nodes are identified based on VM memory and CPU utilization on the node. VMs are then moved (live migrated) from an overcommitted node to nodes with available bandwidth. The aggressiveness of the balancing can be tuned to ensure optimal cluster performance and utilization. Node fairness is disabled when SCVMM Dynamic Optimization is turned on; otherwise, it is on by default

- VM start order

VM start order handles the orchestration for VMs in a cluster. You now can group VMs into tiers and create start order dependencies between different tiers. This ensures that the most important VMs are started first. VMs are not started until the VMs on which they have a dependency are also started.

- VM resiliency

More info To read more, go to <https://blogs.msdn.microsoft.com/clustering/2015/06/03/virtual-machine-compute-resiliency-in-windows-server-2016/>.

Storage

Storage in a modern enterprise used to consist of traditional Fiber Channel or iSCSI storage arrays with shelves of drives. Windows Server 2016 new storage enhancements brings revolutionary new features within reach of every organization with its software-defined feature set.

Storage Replica

Storage Replica is a new feature in Windows Server 2016 with which you can set up storage-agnostic, block-level, synchronous replication between clusters or servers for disaster recovery. You also can use it to stretch a failover cluster across sites for high availability. Synchronous replication makes it possible for you to mirror data in physical sites with crash-consistent volumes, ensuring zero data loss at the file-system level. Asynchronous replication gives you

the ability to extend sites beyond metropolitan ranges with the possibility of data loss. Storage Replica does not operate at a file level as does DFS Replication. Instead, it replicates data blocks and is therefore immune to issues of file locks, open handles, and so on.

More info Storage Replica is a new feature in Windows Server 2016 and the software-defined datacenter, there are no previous enhancements. For more information, go to <http://aka.ms/sroverview>.

Synchronous replication

Synchronous replication guarantees that the application writes data to at least two locations at the same time before completion of the write operation. This replication is most suitable for mission-critical data because it requires network and storage investments and carries a risk of degraded application performance. Synchronous replication is suitable for both high availability (HA) and disaster recovery (DR) solutions.

As Figure 2-51 illustrates, when application writes occur on the source data copy (1), the originating storage does not acknowledge the I/O immediately. Instead, those data changes replicate to the remote destination copy (2) and

log data is written (3). The remote site then returns an acknowledgment (4). Only then does the application receive the I/O acknowledgment (5). This ensures constant synchronization of the remote site with the source site, in effect extending storage I/O across the network. In the event of a source site failure, applications can failover to the remote site and resume their operations with assurance of zero data loss.

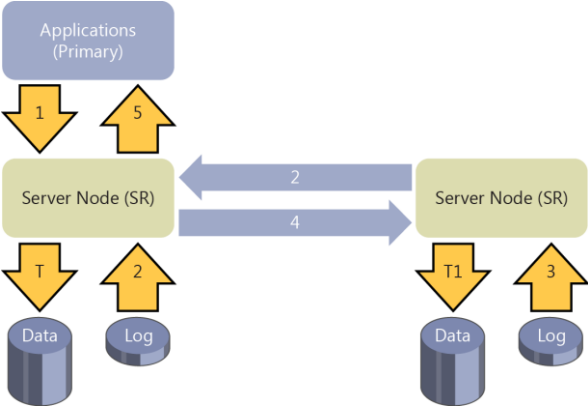

Figure 2-51: Synchronous replication performed by Storage Replica

Note In Figure 2-51, T indicates data flushed to the volume at the source site, and T1 indicates data flushed to the volume at the remote site. In all cases, logs always write through.

Asynchronous replication

In contrast to synchronous replication, asynchronous replication means that when the application writes data, that data replicates to the remote site without immediate acknowledgment guarantees (see Figure 2-52). This mode facilitates faster response time to the application as well as a DR solution that works geographically. With its higher-than-zero Recovery Point Objective (RPO), asynchronous replication is less suitable for HA solutions such as failover clusters because they are designed for continuous operation with redundancy and no loss of data.

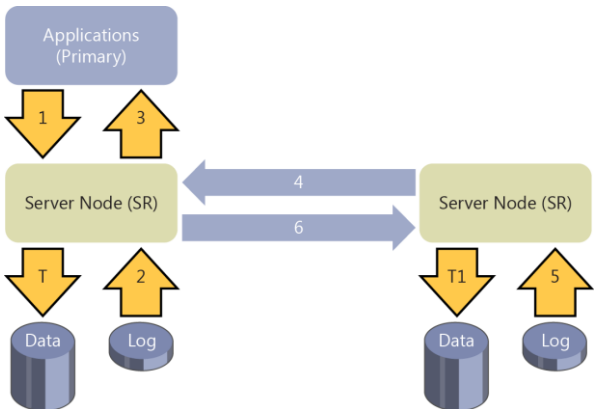

Figure 2-52: Asynchronous replication performed by Storage Replica

As Figure 2-52 illustrates, when the application writes data (1), the replication engine captures and logs the write (2) and immediately acknowledges to the application (3). The captured data then replicates to the remote location (4). The remote node processes the copy of the data, writes log data (5), and lazily acknowledges back to the source copy (6). Because replication performance is no longer in the application I/O path, the remote site's responsiveness and distance are less important factors. There is risk of data loss if the source data is lost while the destination copy of the data is still in buffer without leaving the source.

Implementation-specific details

Storage Replica utilizes SMB 3.0 as a reliable, high-speed data transport for replication. This grants all the advantages of SMB 3.0, such as multichannel, RDMA, encryption, signing, and Kerberos-based security. Storage Replica does not require any changes to Active Directory Domain Services (AD DS) or any domain administrative permissions. The following table summarizes the implementation-specific details of Storage Replica:

Feature	Details
Type	Host-based

Synchronous	Yes
Asynchronous	Yes (server-to-server only)
Storage hardware agnostic	Yes
Replication unit	Volume (partition)
Windows Server Stretch Cluster creation	Yes
Server-to-server replication	Yes
Transport	SMB 3.0
Network	TCP/IP or RDMA
RDMA	iWARP, InfiniBand*
Replication network port firewall requirements	Single IANA port (TCP 445 or 5445)
Multipath/Multichannel	Yes (SMB 3.0)
Kerberos support	Yes (SMB 3.0)
Over the wire encryption and signing	Yes (SMB 3.0)
Per volume failovers allowed	Yes
Management UI in box	Windows PowerShell, Failover Cluster Manager

*Subject to further testing. InfiniBand might require additional long-haul equipment

Note In Windows Server 2016, Storage Replica does not implement transitive replication, the so-called “A-B-C” topology (that is, synchronous replication from server A to server B, and then asynchronous replication from server B to server C). Storage Replica does not implement one-to-many replication. It is possible, for virtualized workloads only, to use Hyper-V Replica as the secondary asynchronous replication mechanism. This means configuring Hyper-V Replica on the source A volume and replicating to a server other than B, forming an “A-to-B + A-to-C” topology.

Requirements

The following are prerequisites for Storage Replica testing:

- Windows Server 2016 Datacenter Edition
- At least 4 GB of physical memory in each server and at least two cores
- AD DS (for SMB to use Kerberos)

There is no need for schema updates, AD DS objects, certain AD DS functional levels, and so on.

- Network

Greater than or equal to 1 Gbps network between servers

Firewall ports open: SMB, WS-MAN

- Storage

One NTFS/ReFS-formatted volume dedicated to replication per server/cluster site with at least 8 GB of free space

GUID partition table (GPT) (not master boot record [MBR])

JBOD, iSCSI, local DAS (non-cluster) SCSI or SATA, Storage Spaces Direct (cluster-to-cluster only), or Storage Array Network (SAN)

Same sector sizes for the data volume drives and for the log volume drives

No %SystemRoot% or page file located on replicated volumes or log volumes

Recommendations

The following are highly recommended for Storage Replica testing:

- Network
 - Bandwidth: ≥ 10 Gbps network between servers
 - Latency: ≤ 5 ms round-trip average for synchronous replication
- Storage
 - Flash (solid-state drive [SSD]) disks for the log volume(s) with at least 8 GB of free space

Tip You can use the Test-SRTopology Windows PowerShell cmdlet to ensure that you meet the requirements and assist with recommended configuration tuning for log files.

Scenarios

Storage Replica was designed with two scenarios in mind:

- Stretching of a failover cluster for high availability

- Replication between servers for disaster recovery

Stretch cluster replication

A *stretch cluster* (also referred to as a *multisite cluster*) uses Storage Replica to connect two sets of asymmetric shared storage within a single failover cluster. This storage can be serially attached SCSI JBOD (just a bunch of drives), iSCSI target, or SAN. Cluster nodes attach to each of the two sets of storage, ostensibly in two physical locations, such as different buildings on the same campus or different metropolitan datacenters. The replicated storage can be either Cluster Shared Volumes (CSV) or role-assigned Physical Disk Resources (PDR).

Figure 2-53 presents the typical architecture used for implementing stretch cluster replication using Storage Replica. On the left is the Redmond site, where there are two servers (SR-SRV-01 and SR-SRV-02) and shared storage (SAN, JBOD, or iSCSI). On the right is the Bellevue site, where there are two more servers (SR-SRV-03 and SR-SRV-04) and more shared storage. You can use Storage Replica to combine the servers and shared storage at these two sites into a single stretched cluster by asymmetrically replicating storage from one site to the other.

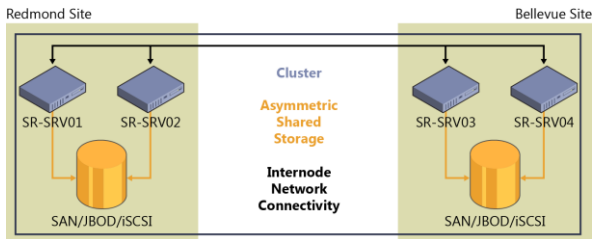

Figure 2-53: Typical architecture used for implementing stretch cluster replication

This configuration makes a failover cluster tolerant not just of node failures, but entire site failures. When a single node in a site fails, another node in that site becomes the new source of replication. When all nodes in a site fail, a node in the other site becomes the source of replication. All of this occurs automatically, just like a normal nonstretched cluster. Stretch clustering requires a minimum of two nodes, and the cluster can contain up to 64 nodes.

In Windows Server 2016, the two cluster roles recommended for replication are Hyper-V and General Use File Server. You should avoid configuring SOFS as a stretch cluster because Windows Server failover clusters are not inherently site aware, and applications will end up connecting to nodes in both sites and then redirecting back to the owning node where I/O writes occur. This potentially can lead to poor

application performance. Microsoft supports the use of VM guest clusters in the for evaluation purposes only.

You can manage this cluster with the Failover Cluster Manager (cluadmin.msc) through a simple wizard-driven interface. To create a stretched cluster, simply create a CSV and configure the General Use File Server role or a Hyper-V VM role. Right-click the source storage (shown in Figure 2-54 as Cluster Disk 3 in the cluster named np-sr-cluster.com), click Replication, and then, on the shortcut menu that appears, click Enable.

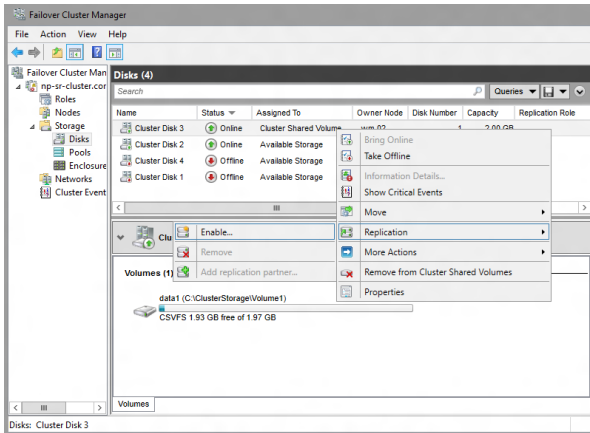

Figure 2-54: Turning on disk replication in Failover Cluster Manager

In the Configure Storage Replica Wizard that opens, on the Select Destination Data Disk page, select a destination drive from the available storage displayed for the source drive that you want to replicate. In Figure 2-55, Cluster Disk 1 is selected as the destination data drive.

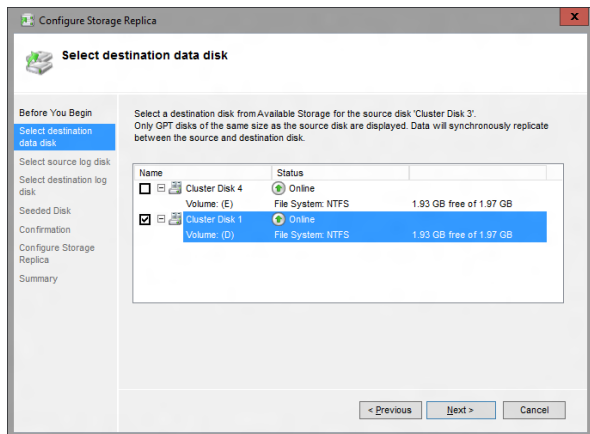

Figure 2-55: Selecting a destination disk for the Replica

Follow the remaining wizard prompts to finish configuring your stretched cluster. When configured, the storage synchronously replicates between the source and destination storage on the cluster. When completed, replication forms the stretch cluster and Storage Replica protects the data on the source and destination drives. For example, Figure 2-56 shows the direction of

replication after a subsequent failover. In this case, Cluster Disk 1 is now the source of replication and Cluster Disk 3 is the destination.

The screenshot displays the 'Disks (4)' window in Windows Server. It contains a table with the following data:

Name	Status	Assigned To	Owner Node	Disk Number	Capacity	Replication Role
Cluster Disk 3	Online	SR Replication 2	wm-02	1	2.00 GB	Destination
Cluster Disk 4	Online	Cluster Shared Volume	wm-01	2	2.00 GB	Log Source
Cluster Disk 1	Online (...)	Cluster Shared Volume	wm-01	1	2.00 GB	Source
Cluster Disk 2	Online	SR Replication 2	wm-02	2	2.00 GB	Log Destination

Below the table, the 'Cluster Disk 1' section is expanded to show 'Volumes (1)'. It displays a volume named 'data1 (C:\ClusterStorage\Volume2)' with a status of 'CSVFS 1.93 GB free of 1.97 GB' and 'Redirected Access'. At the bottom, there are tabs for 'Volumes' and 'Replication'.

Figure 2-56: Disk information after a replica has been created

Note You also can also use the Windows PowerShell Failover-Clustering and StorageReplica modules to create a stretch cluster.

Server-to-server and cluster-to-cluster replication

Storage Replica can connect two individual servers—sometimes called standalone replication—and their volumes. This storage can be serially attached SCSI JBOD, iSCSI target, SAN, or even local DAS, such as SCSI drives attached to a local RAID controller. Storage Replica can also replicate between two clusters as if they were two servers, with any shared storage the cluster considers acceptable. Replication occurs between two physical locations, such as different buildings on the same campus or different metropolitan datacenters. The replicated storage must be either NTFS or ReFS volumes.

Figure 2-57 depicts a typical architecture used for implementing server-to-server replication using Storage Replica. On the left is the Redmond site with server SR-SRV01 and some storage (SAN, JBOD, or iSCSI). On the right is the Bellevue site with server SR-SRV02 and more storage. You can use Storage Replica to combine the servers and storage at these two sites into a partnership by asymmetrically replicating storage from one site to the other.

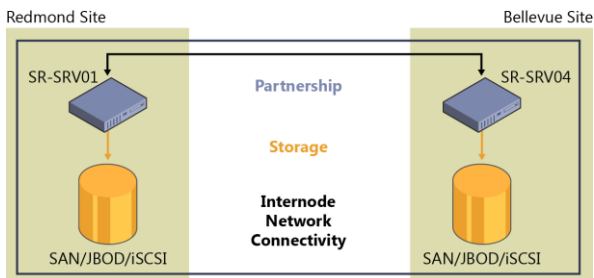

Figure 2-57: Typical architecture used for implementing server-to-server replication

In the server-to-server and cluster-to-cluster scenario, there is no graphical interface and no automatic failover management—all administration is manual and human-driven through the Windows PowerShell StorageReplica module. To ensure ease of provisioning, Storage Replica implements a simple system for configuring replication with a single command when possible.

The Windows PowerShell StorageReplica module contains the following commands in Windows Server 2016:

```
Get-Command -Module StorageReplica | FT -Auto
```

CommandType	Name	Version	Source
Function	Get-SRGroup	1.0	
StorageReplica			
Function	Get-SRPartnership	1.0	
StorageReplica			

Function	New-SRGroup	1.0
StorageReplica		
Function	New-SRPartnership	1.0
StorageReplica		
Function	Remove-SRGroup	1.0
StorageReplica		
Function	Remove-SRPartnership	1.0
StorageReplica		
Function	Set-SRGroup	1.0
StorageReplica		
Function	Set-SRPartnership	1.0
StorageReplica		
Function	Suspend-SRGroup	1.0
StorageReplica		
Function	Sync-SRGroup	1.0
StorageReplica		
Function	Test-SRTopology	1.0
StorageReplica		

Configuring replication is as simple as providing the following information:

```
New-SRPartnership -SourceComputerName np-sr-srv05 -
SourceRGName rg01
-SourceVolumeName g: -SourceLogVolumeName h: -
DestinationComputerName np-sr-srv06
-DestinationRGName rg02 -DestinationVolumeName g: -
DestinationLogVolumeName h:
-LogSizeInBytes 16GB
```

There are many options for the New-SRPartnership cmdlet, including creating asynchronous replication. You also can create replication in a more granular fashion by running New-SRGroup on each server and tying them together by using New-SRPartnership. You can add additional volumes to a replication group by using Set-SRGroup, and you can run more than one replication group on a server at a time.

Storage Replica will include more cmdlets before the final release, including a cmdlet to determine how well replication will perform between two servers over a given network, how to optimally size the replication logs, and what the current write I/O load is on a server you propose for replication—all without the need to install or configure Storage Replica beforehand.

Storage Replica in Windows Server 2016

The following are some of the key things to know concerning Storage Replica as of the Windows Server 2016 release:

- **Network bandwidth and latency with fastest storage** There are physical limitations to synchronous replication. Because Storage Replica implements an I/O filtering mechanism using logs and requiring network roundtrips, synchronous replication is likely to make application writes slower. By using low-latency, high-bandwidth networks as well as high-throughput drive subsystems for the logs, you can minimize performance overhead.
- **The destination volume is not accessible while replicating** When you configure

replication, the destination volume will dismount and no longer be visible in any normal GUI tools or accessible to any writes by users until you remove replication, or the volume becomes the source due to failover.

Block-level replication technologies are incompatible with allowing access to the destination's mounted file system in a volume; NTFS and ReFS do not support users writing data to the volume while blocks change underneath them.

- **Different implementation of asynchronous replication** The Microsoft implementation of asynchronous replication is different than most industry implementations of asynchronous replication that rely on snapshot-based replication, whereby periodic differential transfers move to the other node and merge. In contrast, Storage Replica asynchronous replication operates just like synchronous replication, except that it removes the requirement for a serialized synchronous acknowledgment from the destination. This means that Storage Replica theoretically has a lower RPO as it continuously replicates. However, this also means it relies on internal application consistency guarantees rather

than using snapshots to force consistency in application files. Storage Replica guarantees crash consistency in all replication modes.

- **Storage Replica is not Distributed File System Replication** Volume-level block storage replication is not a good candidate for use in branch-office scenarios. Branch-office networks tend to be highly latent, highly utilized, and lower bandwidth, which makes synchronous replication impractical. A branch office often replicates data in a one-to-many with read-only destinations, such as for software distribution, and Storage Replica is not capable of this in the first release. When replicating data from a branch office to a main office, Storage Replica dismounts the destination volume to prevent direct access.

It is important to note, nevertheless, that many customers use Distributed File System Replication (DFSR) as a DR solution even though it is often impractical for that scenario—DFSR cannot replicate open files and is designed to minimize bandwidth usage at the expense of performance, leading to large recovery-point deltas. Storage Replica might make it possible for

you to retire DFSR from some of these types of DR duties.

- **Storage Replica is not backup** Some IT environments deploy replication systems as backup solutions due to their zero-data-loss options when compared to daily backups. Storage Replica replicates all changes to all blocks of data on the volume, regardless of the change type. If a user deletes all data from a volume, Storage Replica replicates the deletion instantly to the other volume, irrevocably removing the data from both servers.
- **Storage Replica is not Hyper-V Replica or SQL AlwaysOn** Storage Replica is a general purpose, storage-agnostic engine. By definition, it cannot tailor its behavior as ideally as application-level replication. This might lead to specific feature gaps that encourage you to deploy or remain on specific application replication technologies.

Storage Spaces Direct

Storage Spaces Direct enables service providers and enterprises to use industry standard servers with internal drives to build highly available and scalable software defined storage. Using servers

with internal drives decreases complexity, increases scalability, and enables use of storage devices that were not previously possible, such as SATA solid state disks to lower cost of flash storage, or NVMe solid state disks for better performance.

Storage Spaces Direct removes the need for a shared SAS fabric, simplifying deployment and configuration. Instead, it uses the network as a storage fabric, using SMB3 and SMB Direct (RDMA) for high-speed, low-latency CPU-efficient storage. To scale out, simply add more servers to increase storage capacity and I/O performance. Following are some more features and characteristics of Storage Spaces Direct:

- **Storage for Hyper-V and Microsoft Azure Stack** The primary use cases for Storage Spaces Direct is as storage for Hyper-V VMs or as storage for Azure Stack.
- **Hardware** Storage Spaces Direct makes it possible to build highly available and scalable storage solutions using modern storage hardware like SATA SSD for lower cost and NVMe SSD for better performance and less CPU overhead. It can also use RDMA-enabled network infrastructure for low-latency storage with less CPU overhead than traditional Ethernet. Less CPU

overhead means increased workload density.

- **Prescriptive configurations** Microsoft is working closely with its hardware partners to define and validate prescriptive server configurations for Storage Spaces Direct. Using these server configurations provides the best possible experience with Storage Spaces Direct with the full feature set and best performance.
- **Storage Configurations** You can use Storage Spaces Direct with various storage configurations. The most common configurations are:
 - SSDs with traditional hard drives, where the SSDs are used as a read/write cache to accelerate I/O performance.
 - All-flash configuration with NVMe SSDs and SATA SSDs for extremely high I/O performance.
 - Three tiers of physical storage, NVMe SSDs, SATA SSDs, and traditional hard drives.

- **Deployment Choice** Storage Spaces Direct provides customers with a deployment choice, either as hyper-converged infrastructure or as converged infrastructure. In a hyper-converged infrastructure, compute and storage resources are provided by the same machines, simplifying scale and management. In a converged infrastructure, compute resources are separate from storage resources, allowing for increased scalability and independent scaling of compute and storage.
- **Fault Tolerance** Storage Spaces Direct is resilient to drive failures. When drives fail, degraded data is automatically reconstructed on the remaining drives. Storage Spaces Direct supports three fault domain types: a) server, b) chassis, and c) rack, and all data placement, data repair, and data rebalancing will adhere to the fault domain configuration.
- **Accelerated Erasure Coding** Storage Spaces Direct introduces hybrid volumes, which is in addition to the existing mirror and erasure coding volume types. Hybrid volumes mixes the best of mirror (performance) with the best of erasure

coding (efficiency) into a single volume with automatic real-time storage tiering.

- **Efficient VM check-points** Storage Spaces Direct utilizes the new ReFSv2 file system, which when combined with Hyper-V can do very quick and efficient VM checkpoints with little overhead and storage I/O.
- **Scalability** Storage Spaces Direct can scale from 2 to 16 servers. You can add servers as needed, and data can be rebalanced to best utilize the additional resources. Microsoft and Intel demonstrated a 16 server Storage Spaces Direct deployment using all NVMe SSDs at IDF 2015.
- **Health Service** Storage Spaces Direct includes an intelligent built-in diagnostic engine that makes it possible for administrators with limited technical expertise to monitor and operate the system day to day.
 - The Health Service actively monitors the underlying cluster, storage hardware, and software-defined storage stack to detect problems and

generate alerts that contain precise instructions for how to react.

- Performance and capacity information is aggregated to present a holistic, high-level view of available resources.
- Frequent tasks such as drive replacement and drive firmware updates are automated to reduce the burden on the administrator.

To help understand Storage Spaces Direct, let's begin by examining Storage Spaces in Windows Server 2012 R2 HA storage systems. In Windows Server 2012 R2, an HA system using Storage Spaces requires drive devices to be physically connected to all storage nodes. For the drive devices to be physically connected to all storage nodes, they need to reside in an external JBOD chassis, with each storage node having physical connectivity to the external JBOD. Also, because multiple storage nodes will be connecting to each drive, the drive devices need to be serial-attached SCSI (SAS) because the SAS protocol allows for this sharing where drives such as SATA do not allow multi-initiator. Because of these requirements, this deployment is referred to as *Storage Spaces Shared JBOD* to contrast it with Storage Spaces Direct. Figure 2-58 shows a Storage Spaces Shared JBOD deployment.

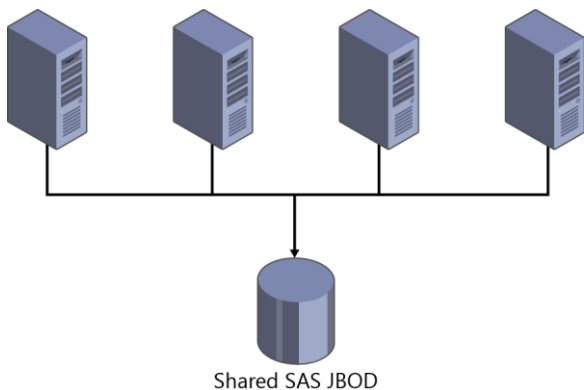

Figure 2-58: An example of a Storage Spaces Shared JBOD deployment

Storage Spaces Shared JBOD provides many benefits compared to past HA storage systems. However, requiring that drive devices are physically connected to every single node limits the type of drive devices that you can use and can lead to complex SAS fabric configurations, especially as these deployments scale out.

With Windows Server 2016 Storage Spaces, you now can build HA storage systems using storage nodes with only local storage, which is either drive devices that are internal to each storage node or drive devices in JBODs, where each JBOD is connected only to a single storage node. This completely eliminates the SAS fabric and its complexities, but makes possible the use of drive

devices such as SATA drive devices, which can further reduce cost or improve performance. Figure 2-59 presents a Storage Spaces Direct deployment.

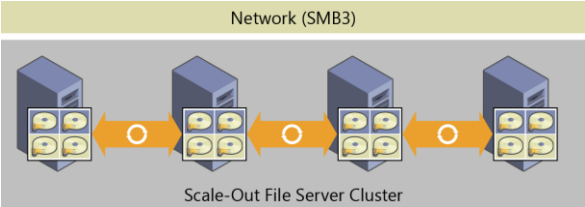

Figure 2-59: An example of a Storage Spaces Direct deployment

It is important to also understand that Storage Spaces Direct is an evolution of Storage Spaces, which means that it is an extension of the existing SDS stack for Windows Server. Another important aspect is that Storage Spaces Direct uses SMB 3.0 for all intranode (also called *east-west*) communication, and takes advantage of all the powerful features of SMB 3.0, such as SMB Direct (RDMA-enabled NICs) for high-bandwidth and low-latency communication, and SMB multichannel for bandwidth aggregation and network fault tolerance.

Implementation details

Storage Spaces Direct seamlessly integrates with the features you know today that make up the Windows Server SDS stack, including SOFS (SMB 3.0), Clustered Shared Volume File System (CSVFS), Storage Spaces, and failover clustering. Figure 2-60 illustrates the Storage Spaces Direct stack.

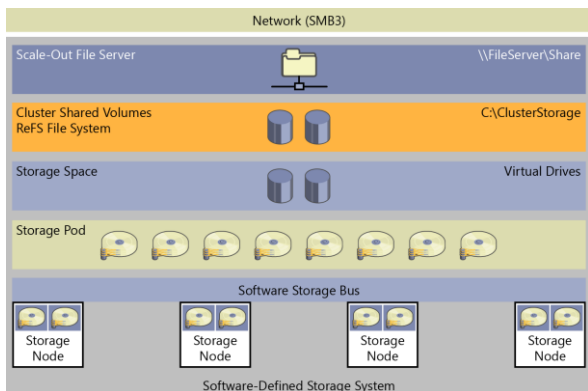

Figure 2-60: The Storage Spaces Direct stack

The updated stack includes the following, starting from the bottom:

- **Hardware** The storage system consists of a minimum of four storage nodes with local storage. Each storage node can have internal drives or drives in an external SAS-

connected JBOD enclosure. The drive devices can be SATA disks or SAS disks.

- **Software Storage Bus** The Software Storage Bus spans all of the storage nodes and brings together the local storage in each node, so all drives are visible to the Storage Spaces layer above.
- **Storage Spaces** Storage Spaces provides storage pools and virtual drives. The storage pool can span all of the local storage across the nodes. The virtual drives provide resiliency to drive or node failures because data copies are stored on different storage nodes.
- **Resilient File System (ReFS)** ReFS provides the file system in which the Hyper-V VM files are stored. ReFS is a premier file system in Windows Server 2016 for virtualized deployments and includes optimizations for Storage Spaces such as error detection and automatic correction. In addition, ReFS provides accelerations for VHD(X) operations such as fixed VHD(X) creation, dynamic VHD(X) growth, and VHD(X) merge. CSVFS layers above ReFS bring all the mounted volumes into a single namespace.

- **SOFS** This is the top layer of the storage stack that provides remote access to the storage system by using the SMB 3.0 access protocol.

Improved scalability

You can deploy Storage Spaces Direct using storage nodes with either local storage or nonshared JBODs. In previous versions of Windows Server, scaling out Storage Spaces solutions required a concurrent increase in the scale of the SAS fabric that joined the storage nodes to the shared SAS JBODs. In contrast, with Storage Spaces Direct, you can set up a model that removes the complexities of the SAS fabric, making scale-out as simple as adding a new storage node, either with internal storage or attached to a nonshared JBOD. Scaling out by adding storage nodes provides more flexibility in storage planning because storage expansion is no longer bound by the number of drive slots in a shared SAS JBOD.

To support this model of just-in-time scale-out, Storage Spaces Direct improves scalability compared to previous versions of Windows Server because you can now manage more drive devices in a single storage pool. Increasing the number of drive devices in a single pool reduces

the number of storage pools that you must create, simplifying management of the storage solution.

Storage Spaces Direct optimized pool

Storage Spaces Direct can optimize a storage pool to balance data equally across the set of physical drives that comprise the pool. Over time, as physical drives are added or removed or as data is written or deleted, the distribution of data among the set of physical drives that comprise the pool can become uneven. In some cases, this might result in certain physical drives becoming full, whereas other drives in the same pool have much lower consumption.

Similarly, if you add new storage to the pool, optimizing the existing data to utilize the new storage results in better storage efficiency across the pool and, potentially, improved performance from the newly available additional physical storage throughput. Optimizing the pool is a maintenance task that the administrator performs.

When the `optimize pool` command is started, Storage Spaces Direct moves data among the physical drives in the pool. The data movement

is a background operation, designed to minimize impact to foreground or tenant workloads.

Failure scenarios

Storage Spaces Direct addresses various failure scenarios. To understand how this works, you first need to review some basic information about virtual drives.

A virtual drive consists of extents, each of which are 1 GB in size. A 100 GB virtual drive will therefore consist of one hundred 1 GB extents. If the virtual drive is mirrored (using `ResiliencySettingName`), there are multiple copies of the extent. The number of copies of the extent (obtained by using `NumberOfDataCopies`) can be two or three. For example, a mirrored virtual drive with three data copies consumes 300 extents. The placement of extents is governed by the fault domain, which in Storage Spaces Direct is nodes (`StorageScaleUnit`), so, as shown in Figure 2-61, the three copies of an extent (A) are placed on three different storage nodes; for example, nodes 1, 2, and 3 in the figure. Another extent (B) of the same virtual drive might have its three copies placed on different nodes; for example, nodes 1, 3, and 4, and so on. This means that a virtual drive has its extents distributed across all

storage nodes and the copies of each extent are placed on different nodes. Figure 3-11 depicts a four-node deployment with a mirrored virtual drive with three copies and an example layout of extents.

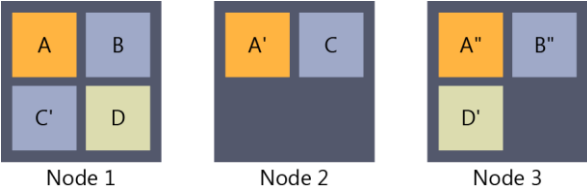

Figure 2-61: A four-node deployment

Next, let's take a look at various failure scenarios and examine how Storage Spaces handles them.

Scenario 1: One or more sectors on a drive has failed

In this scenario, Storage Spaces will reallocate the extent that is affected by the failing sectors. The destination drive for the reallocation could be another drive in the same node or another drive in another node that does not already have a copy of the extent. So, if the three copies of the extent are on node A, B, and C, and the extent on node A is affected by a sector failure, the new copy can be generated on a different drive in node A or any drive in Node D. Drives in

node B and C cannot be used, because these two nodes already have a copy of the extent.

Scenario 2: A drive has failed

In this scenario, Storage Spaces retires the physical drive from the storage pool when it discovers the drive has failed. After the physical drive has been retired, each virtual drive starts its repair process. Because the physical drive has been retired, the virtual drives generate a new copy of the extents that were on the retired physical drive. The new copies follow the same logic as in scenario 1.

Scenario 3: A drive is missing

In this scenario, Storage Spaces will do one of two things:

- If only the physical drive is missing, Storage Spaces will retire the disk.
- If the storage node or the physical enclosure to which the physical drive is attached is also missing, Storage Spaces will not retire the physical drive.

The reason Storage Spaces won't retire the physical drive in this second case is that during a storage node restart or temporary maintenance of a storage node, all the drives and physical

enclosures associated with that node will be reported missing. Automatically retiring all of those drives and enclosures would potentially result in a massive amount of repair activity because you would need to rebuild all of the extents on those drives elsewhere in the storage system. This could easily be multiple terabytes of data. If the drives and enclosures are really missing and will not come back to the storage system, the administrator will need to retire the missing physical drives and start the repair process.

Scenario 4: Storage node restart or maintenance

In this scenario, Storage Spaces does not automatically retire physical drives from the storage pool for the reasons described earlier in scenario 3. When the storage node comes back online, Storage Spaces automatically updates all extents that are not up to date with the copies that were unaffected by the restart or maintenance.

Scenario 5: Permanent storage node failure

In this scenario, Storage Spaces requires the administrator to retire all of the affected physical

drives from the storage pool, add additional storage nodes to the storage system if needed, and then begin repair. This is not an automatic process, because Storage Spaces does not know if the failure is temporary or permanent. It is not desired to initiate a repair that could potentially result in significant repair activity.

More info To learn more about Storage Spaces Direct in Windows Server 2016, go to <https://technet.microsoft.com/library/mt126109.aspx>.

Deduplication

In Windows Server 2016 Deduplication, the core focus is to have significant impact on the scale and performance that you can address with this technology. With this shift in focus, you can now use Windows Server 2016 in the following scenarios:

- Volumes up to 64 TB
- File sizes up to 1 TB
- Virtualized backup
- Nano server support
- Rolling cluster upgrades

Since deduplication was introduced in Windows Server 2012, the core principles for getting the data to a chunked state have remained the same, now let us address what has changed that makes these new scenarios possible.

The optimization engine has been upgraded from single thread to multiparallel thread using multiple I/O streams, as shown in Figure 2-62.

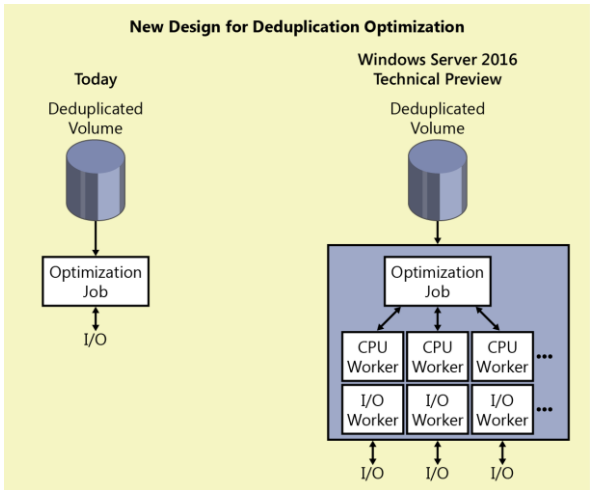

Figure 2-62: Single-thread processing versus parallel processing

On top of this parallel execution, the algorithm for processing files has been redesigned using a new stream map structure and improved partial

file optimization. This accommodates the scalability and performance to handle files up to the 1 TB size limit. Figure 2-63 shows how the mapping technology has changed to allow for better optimization overall on the volume.

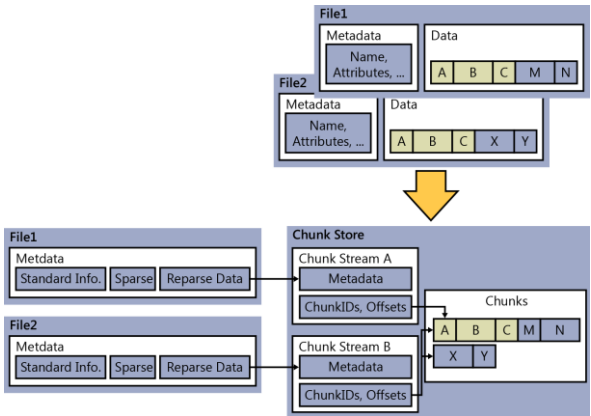

Figure 2-63: Old mapping versus the new stream map structures in windows 2016

Although Microsoft technically supported and provided guidance to use deduplicated volumes with DPM in Windows Server 2012 R2, now further improvements to ensure ease of configuration and support are included within Windows Server 2016. You can configure this directly in the Windows 2016 GUI or via Windows PowerShell by using the Enable-DeDup cmdlet, but including the new Backup attribute.

```
Enable-DedupVolume -Volume <volume> -UsageType  
Backup
```

Another new great option is support for rolling cluster upgrade. You can begin the process of upgrading your cluster nodes to Windows Server 2016 and maintain the deduplication process in Windows 2012. Previously this was unsupported. During the migration to Windows 2016, all jobs will run in Windows 2012 mode.

Finally, a minor update, but one still worth noting, is the availability of a Storage Management API (SMAPI) interface for use with System Center Virtual Machine Manager 2016. This makes it possible for you to set up storage deduplication and status reporting from within System Center Virtual Machine Manager 2016.

Storage Quality of Service

One of the “missing” features from previous editions of Windows Server was the ability to apply Quality of Service (QoS) policies in relation to storage traffic. This became a huge problem in virtualization estates; if you wanted to prioritize certain workloads and give them, for example, a guaranteed level of I/O operations per second (IOPS), you simply couldn’t do it.

In Windows Server 2016, you can now enforce resource fairness or prioritization depending on the policies that you want to configure for your storage. The core usage of storage QoS will be focused around Hyper-V VMs deployed on either a SOFS or Hyper-V Cluster with Cluster Shared Volumes.

Figure 2-64 demonstrates that we can create various policies and apply them to our different VMs, giving you the ability to have different service standards or prioritize business-critical workloads.

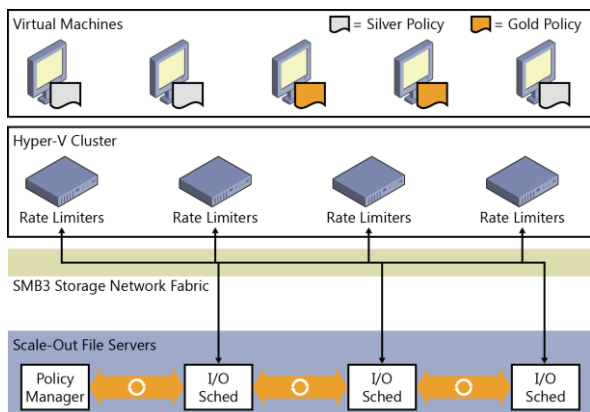

Figure 2-64: Storage QoS policies and their application to different VM tiers

Storage QoS in Windows Server 2016 is turned on by default. This means that you don't need to install an additional role or feature to get going.

For example, Figure 2-65 illustrates that if you have a Hyper-V failover cluster, you can see that a new cluster resource is listed.

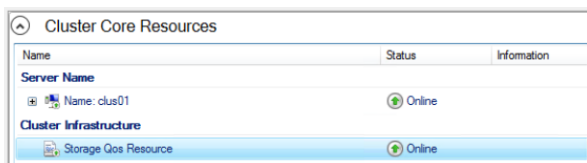

Figure 2-65: Storage QoS Cluster Core Resource

You also can use the Windows PowerShell cmdlet `Get-ClusterResource` to display the same result:

```
Get-ClusterResource -Name "Storage Qos Resource"
```

Storage QoS will work effectively only if you decide to configure appropriate policies. You can use policies to control the traffic flow as necessary based on your requirements. You can configure Storage QoS policies on the SOFS. You essentially have a choice of two policy types:

- **Single-instance** Using single-instance policies, you can create a minimum and maximum amount of IOPS per policy. This is aggregated against a VM. For example, if a

VM has a single VHD/VHDX, it will have full use of all the IOPS in the assigned policy. However, if the VM has three VHD/VHDX and they are all assigned the same single-instance policy, that VM will share the maximum number of IOPS across all drives, degrading the overall performance. You have the option to have multiple single-instance policies and configure each drive to use a different single-instance policy to ensure that they get access to all the IOPS. If you have two VMs with a single VHD each and all assigned to the same single-instance policy, they will also share the minimum and maximum IOPS.

- **Multi-instance** With multi-instance policies, again you have options to create a minimum and maximum number of IOPS. However, in this scenario, if you had two VMs with a single VHD/VHDX each, they will get their own allocation of IOPS, both minimum and maximum. However, the same rules apply that if the VM had multiple disks: unless assigned individual policies, they will share the total amount of assigned minimum and maximum IOPS.

To create a policy, use the following Windows PowerShell cmdlet:

```
$GoldVmPolicy = New-StorageQosPolicy -Name Gold -  
PolicyType MultiInstance -MinimumIops 100 -  
MaximumIops 500
```

This sample will store information about the policy in the variable. There is one property called the `PolicyId`, which you will require. To access the `PolicyId` use the following syntax:

```
$GoldVmPolicy.PolicyId
```

```
Guid
```

```
----
```

```
Cd5f6b87-fa15-402b-3545-32c2f456f6e1
```

The `Guid` is what you will require to apply this policy to a VHD by using the following Windows PowerShell command:

```
Get-VM -Name GoldSrv* | Get-VMHardDiskDrive | Set-  
VMHardDiskDrive -QoSPolicyID Cd5f6b87-fa15-402b-  
3545-32c2f456f6e1
```

After the policy is applied, you will, of course, want to verify that the policy is indeed active, but also you will want to monitor if it is having the appropriate effect. You can do this by using the `Get-StorageQoSFlow` cmdlet.

The following output shows what is applied and the amount of storage the IOPS the VM is actually using:

```
Get-StorageQoSFlow -InitiatorName GoldVm1 | Format-  
List
```

```
FilePath:c:\ClusterStorage\Volume1\VMS\Gold\GoldVM1.
```

VHDX

```
FlowId: ebfecb54-e47a-5a2d-8ec0-0940994ff21c
InitiatorId      : ae4e3dd0-3bde-42ef-b035-
9064309e6fec
InitiatorIOPS    : 464
InitiatorLatency : 26.2684
InitiatorName    : GoldVM1
InitiatorNodeName : node1.contoso.com
Interval        : 300000
Limit           : 500
PolicyId        : cd5f6b87-fa15-402b-3545-
32c2f456f6e1
Reservation      : 500
Status          : Ok
StorageNodeIOPS : 475
StorageNodeLatency : 6.5625
StorageNodeName  : node1.contoso.com
TimeStamp       : 2/12/2016 3:28:49 AM
VolumeId        : 2d34fc5a-2b3f-9922-23f4-
43563b2a6787
PSComputerName  :
MaximumIops     : 100
MinimumIops     : 500
```

You can use the `Get-StorageQoSFlow` cmdlet to validate before you create policies what the VMs are actually using in relation to Storage IOPS.

```
Get-StorageQoSFlow | Sort-Object StorageNodeIOPS -
Descending | ft InitiatorName,
@{Expression={$_.InitiatorNodeName.Substring(0,$_.In
itiatorNodeName.IndexOf('.')});Label="InitiatorNodeN
ame"}, StorageNodeIOPS, Status,
@{Expression={$_.FilePath.Substring($_.FilePath.Last
IndexOf('\')+1)};Label="File"} -AutoSize
```

```
InitiatorName InitiatorNodeName
StorageNodeIOPS Status File
```

```
-----
--  ----
GoldVM5          node1          2482
Ok IOMETER.VHDX
```

GoldVM2	node2	344
Ok BUILDVM2.VHDX		
GoldVM1	node2	597
Ok BUILDVM1.VHDX		
GoldVM4	node1	116
Ok BUILDVM4.VHDX		
GoldVM3	node2	526
Ok BUILDVM3.VHDX		
GoldVM4	node1	102
Ok		

More info You can find additional scenarios to get started with Storage QoS on Windows 2016 at

<https://technet.microsoft.com/library/mt126108.aspx>.

Networking

As the evolution of software-defined datacenters (SDDCs) continues, traditional networking methods such as virtual Local Area Networks (VLANs) begin to become difficult to manage and maintain. The requirements to centrally manage and control the network landscape directly from software to dynamically create what is needed when it is needed is a key piece to this evolving concept. Introduced in Windows Server 2012 R2, software-defined networking (SDN) has evolved further to become more Azure consistent.

In this section, we will explore the following areas:

- Network virtualization
- Network Controller
- Remote Access Service (RAS) Gateway
Multitenant Border Gateway Protocol (BGP)
Router
- Software load balancer
- Datacenter firewall
- Windows Application Proxy (WAP)

Network virtualization

For IT pros managing the IT infrastructure, efficiency in hardware resources is a major consideration in the decision-making process. In the past decade, this mindset has contributed to bringing virtualization into the mainstream enterprise and achieving the efficiency of have a one host to many different workload approach. With networking, there are some inherent limits within the stack, such as a maximum of 4,096 VLANs. Even though this is a large number, there are segments within the industry (such as service providers) for which that number can be reached quickly. In these cases, virtualized networks can

provide a solution. However, this is not the only case in which network virtualization is interesting. Take, for example, a company that expands via acquisition. In that scenario, the company might purchase companies in which IP spaces overlap the enterprise network plan or layout. What if the acquired companies have licensing agreements that are tied to the IP addresses on the servers and the agreements are not easily broken or the original company no longer exists?

Whatever the case, network virtualization provides the foundation for achieving an SDN solution for the datacenter, as demonstrated in Figure 2-66.

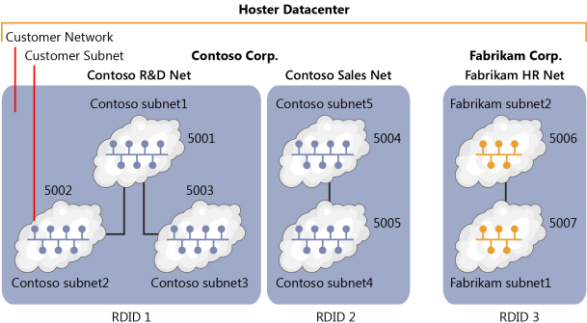

Figure 2-66 Network virtualization

Figure 2-66 illustrates some key concepts. The first is the *routing domain ID*, or RDID. You also

can consider this as the virtual network, such as in Azure. Each virtual network is the boundary of isolation in that network, meaning that only subnets within that virtual network can communicate with one another. Because a virtual network is Layer 3 (i.e., IP), it makes it easy to isolate the traffic between the different networks. The isolation is enforced through Network Virtualization Generic Route Encapsulation ID (NVGRE ID) or Virtual Extensible Local Area Network (VXLAN) Network Identifier (VNI) field. In each routing domain, we can have multiple virtual subnets (VSID), and they have the ability to communicate with one another. In Figure 2-66, RDID 1 has three subnets, each with different VSIDs. If VSID 5001 wants to communicate with VSID 5002, it is possible via Layer 2 to forward within the virtual switch. When the packet traverses the switch, it becomes encapsulated and mappings are applied (encapsulation header), and then it is sent to the destination Hyper-V port or destination switch. To summarize, if traffic has the same RDID, it can be forwarded between VSIDs; if the RDIDs are different, you need to make use of a gateway.

For network administrators who are used to the concepts such as Address Resolution Protocol (ARP) broadcast, Media Access Control (MAC) addresses, and broadcast domain, these

concepts all technically still apply but now fall into specific buckets. For example, if we take VSID 5001, it can be considered to be a broadcast domain or VLAN. Now, if two machines in VSID 5001 want to communicate with each other, they look up a MAC address via an ARP query to the Hyper-V switch. The Hyper-V switch has a Hyper-V port for every network adapter in a VM, and we know that every network adapter has a MAC address. The Hyper-V switch will keep a lookup table or ARP table of these entries so that if an ARP query comes in, it knows to which destination to switch the traffic. If no entry exists, it will generate an ARP broadcast in an attempt to find what port hosts the computer to which it wants to send the traffic. This subnet or VSID will also have an IP subnet allocated to it, something like 192.168.0.0/24, which could be a subset of the virtual network allocation of 192.168.0.0/16.

Hyper-V Network virtualization on a single host is a relatively easy concept. However, when you introduce multiple hosts that span the datacenter and you want to honor the RDID and VSID of isolated networks and subnets across the datacenter, the topic becomes a little more complex and you must introduce some address space concepts. Figure 2-67 shows a basic

concept in which there are multiple subnets that overlap one another.

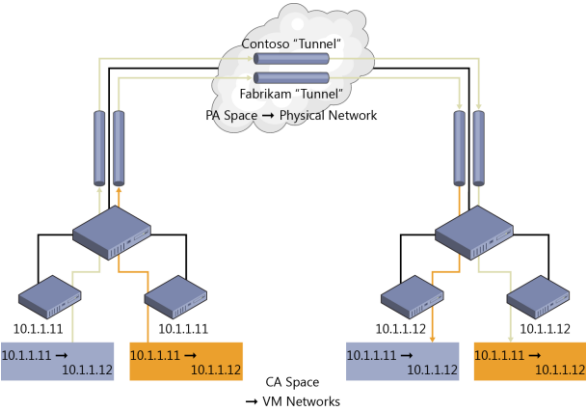

Figure 2-67: Address space concepts

If we did not have these subnets isolated, we would get in a lot of trouble on our networks and things certainly would not work properly. However, because network virtualization isolates the IP address space, they can coexist easily on the same physical network. First, take the Blue network in Figure 2-67, or the Red network; these address spaces signify the *Customer Address (CA) Space*. For them to communicate between hosts across a physical network, they must be encapsulated via a common IP subnet. This common subnet that connects the host is called the *Provider Address (PA) Space*.

Essentially, what then happens is the CA Space is mapped to an IP address in the PA space, and when VMs allocated to the CA space want to communicate across hosts, they do so via their mapped IP in the PA space.

How this mapping happens depends on the type of technology you use. In network virtualization, you can use VXLAN or NVGRE

The following is an extract from Technet (<https://technet.microsoft.com/library/mt238303.aspx>) detailing VXLAN and NVGRE:

The Virtual eXtensible Local Area Network (VXLAN) (RFC 7348) protocol has been widely adopted in the market place, with support from vendors like Cisco, Brocade, Arista, Dell, HP, and others. The VXLAN protocol uses UDP as the transport. The IANA-assigned UDP destination port for VXLAN is 4789 and the UDP source port should be a hash of information from the inner packet to be used for ECMP spreading. After the UDP header, a VXLAN header is appended to the packet which includes a reserved 4-byte field followed by a 3-byte field for the VXLAN Network Identifier (VNI) – VSID – followed by another reserved 1-byte field. After the VXLAN header, the

original CA L2 frame (without the CA Ethernet frame FCS) is appended.

NVGRE is used as part of the tunnel header. In NVGRE, the VM's packet is encapsulated within another packet. The header of this new packet has the appropriate source and destination PA IP addresses in addition to the VSID, which is stored in the Key field of the GRE header, as shown in Figure 2-68.

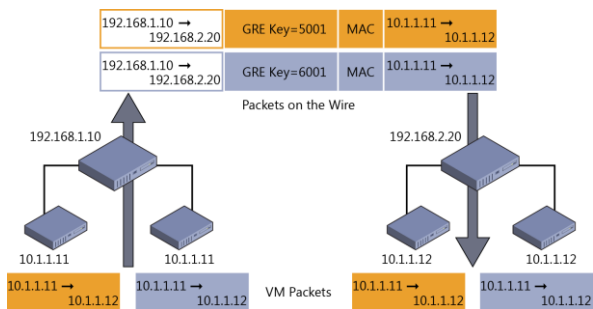

Figure 2-68: NVGRE

Network Controller

In Windows Server 2016, it is very important to note that this is a new implementation of the network virtualization approach. Let's call it V2. Why is this important? Well, a lot of things have fundamentally changed and in V2, being consistent to how network is structured and

implemented in Azure was a principal goal. Although the common concept remains the same say for network virtualization as we generally described earlier, it means some overhauled technology in Windows Server 2016. One of the first things worth mentioning before diving into Network Controller and the Software Load Balancer is that the Hyper-V extensible switch has also changed; this means that extensibility options which were implemented in V1 of network virtualization will not work on V2. V2 implements the Azure Virtual Filtering Platform technology to ensure the consistency model across the private and public cloud.

In this section, we are going to describe Network Controller, which essentially is now the brain of the virtualized network solution that we will implement. In large, complex networks with traditional networking technology, we would have implemented a central tool to manage these networks. Using these traditional tools, we would provide a central point of management so that we can automate configuration, maintenance, backup, and troubleshooting of the physical switch environment. In a virtualized network environment, this is exactly what Network Controller will do.

Network Controller can interact with the network and be interacted with through two different APIs specifically for each function. The Northbound API (implemented as a REST API) is used to interact with Network Controller and monitor the network as well as implement configuration changes. The Southbound API is used to interact with network devices and detect service configurations and basically understand the network. Using tools such as System Center Operations Manager and System Center Virtual Machine Manager, you can manage and monitor your network directly from these consoles.

Because Network Controller is considered the brain, it can manage all of the networking virtualization technologies included with Windows Server 2016. The following table gives a breakdown of the areas Network Controller can manage and a description of the types of management it can do.

Component	Manageable areas
Fabric network management	<ul style="list-style-type: none"> • Physical fabric management • IP subnets • VLANS • Layer 2 switches • Layer 3 switches • Network adapters in hosts
Firewall management	<ul style="list-style-type: none"> • Manage firewall rules into the vSwitch port of the VM estate • Log traffic centrally on the switch
Network monitoring	<ul style="list-style-type: none"> • Monitoring physical network • Monitoring virtual network • Active networking monitoring

	<ul style="list-style-type: none"> • Element data collected using SNMP polling and traps • Impact analysis
Network topology and discovery management	<ul style="list-style-type: none"> • Discovery of network topology through elements
Software load balancer	<ul style="list-style-type: none"> • Manage and configure load balancing rules
Virtual network management	<ul style="list-style-type: none"> • Virtual network policies • All elements of network virtualization
RAS gateway management	<ul style="list-style-type: none"> • Add and remove gateway VMs from the cluster and specify the level of backup required • Site-to-site Virtual Private Network (VPN) gateway connectivity between remote tenant networks and your datacenter using IPsec

- Site-to-site VPN gateway connectivity between remote tenant networks and your datacenter using Generic Routing Encapsulation (GRE)
- Point-to-site VPN gateway connectivity so that your tenants' administrators can access their resources on your datacenter from anywhere
- Layer 3 forwarding capability
- Border Gateway Protocol (BGP) routing, with which you can manage the routing of network traffic between your tenants' VM networks and their remote sites

More info In this book, we cannot provide an exhaustive review of all features and details in relation to Network Controller. We encourage you to review the public TechNet article at <https://technet.microsoft.com/en-US/library/dn859239.aspx> for additional information.

Additionally, Network Controller is a complex element to deploy and get working. The following articles will provide you with the most up to date documentation for deploying and configuring Network Controller in Windows Server 2016:

“Installation and preparation requirements for deploying Network Controller”:
<https://technet.microsoft.com/library/mt691521.aspx>

“Deploy Network Controller using Windows PowerShell”:
<https://technet.microsoft.com/library/mt282165.aspx>

RAS Gateway multitenant BGP router

When you deploy network virtualization and employ the encapsulation and isolation methods described earlier in this chapter, you face an interesting problem: How do the VMs in these isolated networks communicate outside the

isolated network? How do external machines communicate with these isolated VMs if they needed to?

Windows Server 2016 introduces additional capability to the RAS Gateway role to include BGP support. Earlier versions supported the following features for RAS Gateway:

- Site-to-site VPN
- Point-to-site VPN
- GRE tunneling
- NAT

Given that all these features are now available in RAS Gateway, you can reap the following benefits:

- VMs can talk to other networks outside the routing domain to which they are assigned.
- You can create endpoints into the virtual network if required.
- You can connect virtual and physical networks together.

With the introduction of BGP, new possibilities open up for our network environments. For

example, Express route works on BGP, not to mention the Internet!

BGP dynamically learns which networks are attached and announces these networks to other BGP-capable routers. The other BGP-capable routers can populate their routing table with the entries, and if the BGP router receives a request to send traffic to a tenant's network, it will know how to route the traffic appropriately. An important part of BGP is the ability to provide route redundancy and automatically recalculate the best route to the desired network. In that case, if you have several routers connected together and there were multiple paths to a desired network, BGP would work out the optimal route to it. Then, in the event of a failure, it would recalculate the route and announce it back to its BGP peers.

One of the challenges in relation to virtualized networks and the RAS Gateway in Windows Server 2012 is the relationship of gateways. If you want to deploy a HA pool of gateways in Windows Server 2012, there is no way to separate the gateway pool for separate functions or tenants. There are also strict placement requirements of the Gateway Nodes, which cause a lot of network problems in enterprise clusters.

Windows Server 2016 implements a true pool model in which you can create pools for specific functions or mix the functions. Figure 2-69 shows how you can deploy pools for different functions.

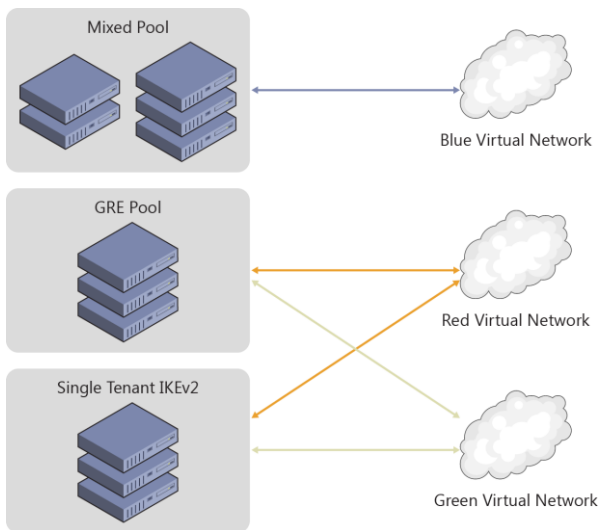

Figure 2-69: RAS Gateway pools

More info RAS Gateway Multitenant BGP Routing is a complex area for discussion and is constantly changing. To view the latest information, go to

<https://technet.microsoft.com/library/mt679502.aspx>

Software Load Balancing

Windows Server 2016 introduces Software Load Balancing, which provides HA and scalability to tenant workloads. Software Load Balancing includes the following features:

- Layer 4 (L4) load balancing services for “North-South” and “East-West” TCP/UDP traffic.
- Public and internal network traffic load balancing.
- Supports dynamic IP addresses on VLANs and on virtual networks that you create by using Hyper-V Network Virtualization.
- Health probe support.
- Ready for cloud scale, including scale-out capability and scale-up capability for multiplexers and host agents.

Software Load Balancing has been specifically designed to handle throughput on a scale of tens of gigabytes per cluster, making this a

viable alternative to traditional hardware load balancers.

Before we dive into Software Load Balancing, let's define a few terms:

- **Virtual IP address** This is the IP to which external connections will route.
- **Dynamic IP address** This is the set of IPs on the VMs backing the service.

When you have a service that requires Software Load Balancing, Network Controller is notified of the request and provisions a Software Load Balancing multiplexer. You can have several different multiplexers in an environment. Each multiplexer will be assigned a virtual IP address. The BGP then announces the virtual IP address to the network. The multiplexer is also responsible for accepting connections and routing them to the VMs backing the service. Because the virtual IP address is announced through BGP and is controlled by Network Controller, in the event of a multiplexer failure, Network Controller has the ability to recover by initiating a new multiplexer and reannouncing the routes through BGP. Figure 2-70 shows the Software Load Balancing architecture.

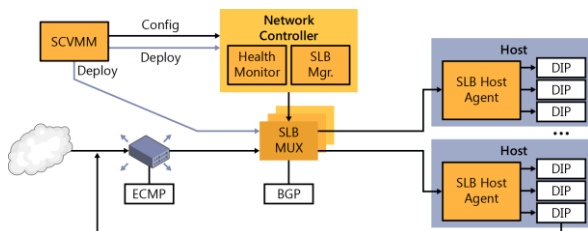

Figure 2-70: An overview of Software Load Balancing

More info Software Load Balancing requires that Network Controller be installed and configured. For instructions on how to do this, go to the TechNet article at <https://technet.microsoft.com/library/mt632286.aspx>.

Datacenter firewall

Introduced in Windows Server 2016, the datacenter firewall is designed to be a network-layer firewall with the following features:

- Stateful packet inspection
- Multitenant
- Five-tuple rule matching (Protocol, source and destination port numbers, source and destination IP addresses)

This is a multitenant option; you can use it to protect tenant VM workloads and configure it via the tenant administrators. This means that it can implement the security policies by which your organization is governed. Figure 2-71 illustrates the datacenter firewall.

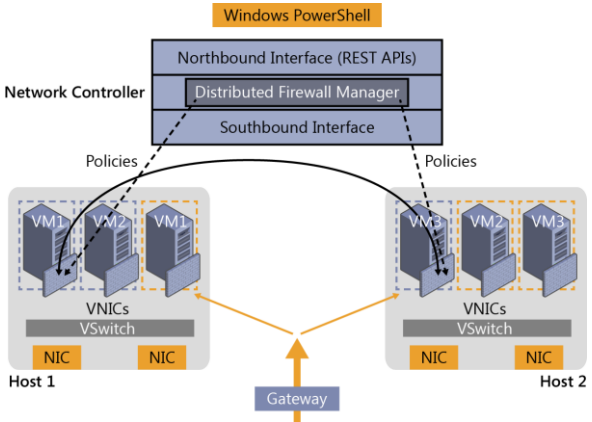

Figure 2-71: Datacenter firewall

The datacenter firewall is controlled by Network Controller. The tenant administrator can configure policies and apply them directly to a Vport on the Hyper-V switch. Additionally, as tenant workloads move around the datacenter, the policy for the tenant can follow them on their journey between hosts.

Web Application Proxy

In this section, Yuri Diogenes and David Branscome demonstrate how you can use the updated Web Application Proxy in Windows Server 2016 to easily access information from anywhere.

Publishing capability enhancements

Users can access company data by using different form factors (e.g., laptop computers, tablets, and smartphones), which here, for simplicity, we will just refer to as *devices*. These devices can originate requests from different locations, but the users expect to have an experience similar to what they have when they are on-premises. IT must ensure that the entire communication channel is secure, from data at rest in the datacenter (on-premises or in the cloud), to data in transit until it reaches the destination device. There, it will also be at rest and must also be secure.

To make it possible for users to securely access company data, Web Application Proxy in Windows Server 2016 was enhanced to cover more bring-your-own-device (BYOD) scenarios, such as Pre-Auth with Microsoft Exchange Server, which we will discuss later in more detail. Web Application Proxy continues to make use of

Active Directory Federation Services (AD FS) and AD DS for authentication and authorization. This integration is very important for BYOD scenarios because it provides the capability to create custom rules for users who are accessing resources while physically located on-premises versus those accessing resources via the Internet.

Note If you are not familiar with Web Application Proxy in Windows Server 2012 R2, read the article at <http://technet.microsoft.com/library/dn584107.aspx>.

The Web Application Proxy installation experience is similar to that in the previous version of Windows Server 2012 R2; therefore, you can use the same steps to install it in Windows Server 2016. When the installation is complete, you are prompted to perform the post-deployment configurations, as shown in Figure 2-72.

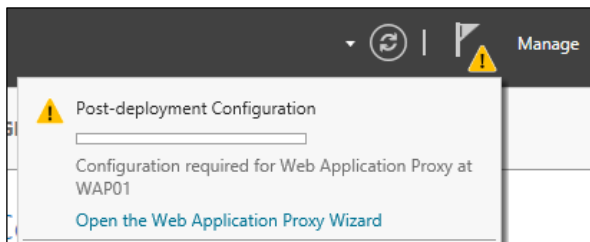

Figure 2-72: Post deployment configuration for Web Application Proxy

Note Before you deploy Web Application Proxy, ensure that you plan the infrastructure according to the recommendations from the article at <http://technet.microsoft.com/library/dn383648.aspx>. This article was written for Windows Server 2012 R2, but the recommendations still apply to Windows Server 2016.

When you finish the post-deployment steps, which are basically connecting your Web Application Proxy server to the AD FS server, you will be able to use the Publish New Application Wizard. You will notice some changes that were introduced in this new version. The first change you will notice when you click Publish under the Web Application Proxy management tool are the options available in the left pane. For example, on the Preauthentication page, you can choose either Active Directory Federation Services (AD FS) or Pass-Through for the preauthentication method, as shown in Figure 2-73.

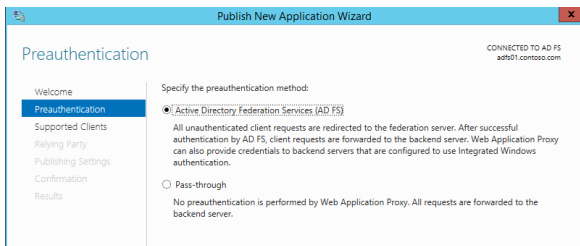

Figure 2-73: Preauthentication selection

For the purpose of this example, select Active Directory Federation Services (AD FS) as the preauthentication method, and then click Next. On the Supported Clients page, your options are Web And MSOFBA, HTTP Basic, or OAuth2, as depicted in Figure 2-74.

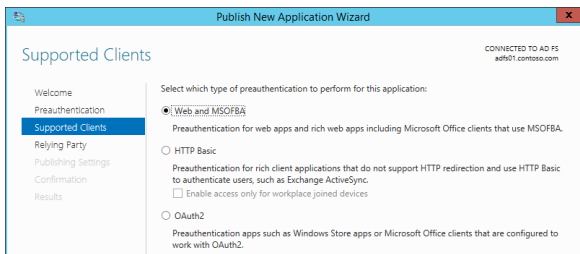

Figure 2-74: Supported clients

You can use the Web and MSOFBA option to preauthenticate clients by using the Microsoft Office Forms Based Authentication (MSOFBA) protocol. MSOFBA provides form-based authentication instead of basic or NTLM authentication when you use Office client applications. The second option is the well-known HTTP basic authentication that you can use in scenarios such as Exchange Active Sync (ActiveSync). This is a new capability included in this release of Web Application Proxy. For the ActiveSync scenario, the authentication process includes four core steps:

1. WAP stops the request and passes all credentials to AD FS.
2. AD FS validates, applies policy, and replies with a token.
3. Upon success, Web Application Proxy allows the request to pass to the Exchange server.
4. Web Application Proxy caches the token for future use.

The third option is OAuth2, which is an authorization framework that many vendors use, including Microsoft. Web Application Proxy has supported OAuth2 since Windows Server 2012

R2; however, the option was not available in the user interface (UI).

More info To learn more about OAuth2, go to <http://tools.ietf.org/html/rfc6749>. You can find additional information about AD FS support for OAuth2 at <http://technet.microsoft.com/library/dn383640.aspx>.

After you select the appropriate client for the publication, click Next. The Publishing Settings page includes one new option with which you can turn on HTTP-to-HTTPS redirection, as illustrated in Figure 2-75.

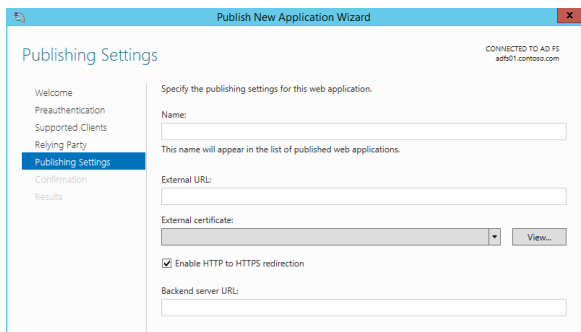

Figure 2-75: Publishing settings

This is a great addition because to turn on HTTP-to-HTTPS redirection in Windows Server 2012 R2, you were required to install and configure

Internet Information Services (IIS). Notice that this option is selected by default, but ensure that it is selected for your app before clicking Next and moving on to the Confirmation page.

Remote Desktop Gateway scenario

The changes that were first introduced in the Windows Server 2012 R2 August 2014 update package regarding the way Web Application Proxy handles Remote Desktop Gateway publication is incorporated in this release. This change simplifies the deployment experience for IT administrators who are planning to publish RDP via Web Application Proxy and makes it possible for Remote Desktop Gateway to pick up the session cookie that was used by Remote Desktop Web Access to authenticate the RDP over HTTP traffic.

Auditing access to resources

Windows Server 2016 introduces a new capability that gives IT administrators better audit access to published resources. Web Application Proxy now adds to every request an X-Forwarded-For (XFF) header to verify whether the header already exists. If so, Web Application Proxy concatenates the client IP to this header.

Note XFF is a nonstandard HTTP header that became the de facto standard. It is used extensively by proxy servers to identify the IP of an originated request. For more information about this, read the RFC at <http://tools.ietf.org/html/rfc7239>.

Another important aspect of Web Application Proxy auditing capabilities are the events that are logged in the Event Viewer. In this release, the Event Viewer includes many more events, such as analytics and debug logs. You will review some examples of these events in the section "Web Application Proxy troubleshooting" later in this chapter.

Taking application proxies to the modern IT world

A few years ago, our team had a big dilemma. We had two products in the market: Forefront Threat Management Gateway and Forefront Unified Access Gateway. Both of these products had been around for many years and had been deployed by tens of thousands of customers. Both of them had evolved since they were first introduced during the 1990s.

However, both products had similar issues: They were very complex products that were difficult to deploy, troubleshoot, and maintain.

This was partly because over the years they accumulated many capabilities that became irrelevant. At the same time, they lacked or had limited support for modern technologies such as federation and OAuth2. On top of it all, they were expensive products that had their own licenses.

It was a tough decision, but we decided to start from a blank page, to examine all the functionality of reverse proxy, to pick and choose only the technologies that matter today, and to implement them by using a fresh code base built on the most modern standards. A big part of this decision was that we wanted to embed the reverse proxy into Windows Server. We wanted to make it just like any other role service available to install from Server Manager. For us, this meant adhering to the strictest standards regarding code and management. Microsoft customers expect that all Windows Server role services are managed the same way, including in Windows PowerShell, the administrator UI, the remote administrator UI, performance counters, the System Center Operations Manager pack, event logs, and so on.

This is how Web Application Proxy was born in Windows Server 2012 R2. We made no compromise on code security, management, and standardization. And, we were happy that customers got it. Companies were able to deploy and integrate Web Application Proxy into their infrastructure very easily.

The downside of this approach is that we were not able to include all of the functionality we wanted to have—functionality that would make it possible for all customers to move from Threat Management Gateway and Unified Access Gateway to the new solution. However, now that we have built a solid foundation, it is easier to add more functionality to make Web Application Proxy the obvious choice to publish on-premises resources such as Microsoft SharePoint, Lync, and Exchange to remote users. This version marks an important milestone in the journey we began quite a few years ago.

Now, it is time for us to begin another journey to bring remote access to the cloud era. We have created Azure Active Directory Application Proxy as another tool for customers to publish applications in cloud-based solutions. Fortunately, Web Application Proxy in Windows Server and Azure Active Directory Application Proxy share a lot of code. More than that, they share the same concepts and perception of remote access and how to make it simple to deploy and easy to maintain.

Going forward, we will continue to develop both products. We plan to offer Microsoft customers a choice with regard to which architecture to use. The cloud offers users a unique and highly efficient way to implement remote access utilizing the rich functionality and robust security mechanisms of Azure Active Directory, without the need to change their perimeter network. The same service that takes care of 18 billion authentication requests per week handles your on-premises applications.

Meir Mendelovich, Senior Program Manager

Publishing Exchange Server 2013

As noted earlier, the retirement of Forefront Threat Management Gateway left a number of Exchange administrators in a quandary about how to publish their Exchange server to the Internet. Although large organizations can generally take advantage of an existing hardware load balancer infrastructure to accomplish this task, small- and medium-sized businesses might not have the funds or expertise to manage a load balancer. This is where the Web Application Server role can be very useful.

The basic principles for publishing Exchange 2013 Outlook Web App and the Exchange Admin Center through Web Application Proxy are outlined in detail at

[http://technet.microsoft.com/library/dn635116\(v=exchg.150\).aspx](http://technet.microsoft.com/library/dn635116(v=exchg.150).aspx). However, to get a better understanding of some of the capabilities of Web Application Proxy on Windows Server 2016, consider the very simple scenario illustrated in Figure 2-76.

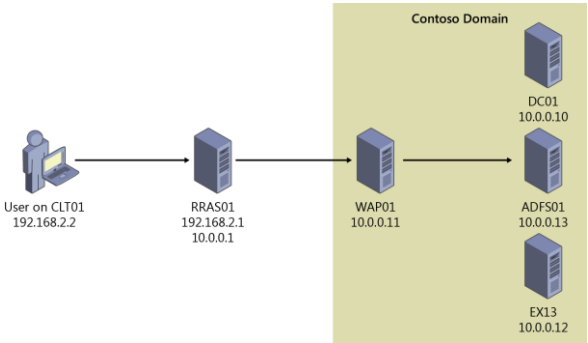
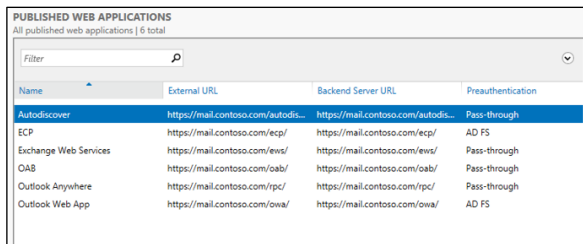

Figure 2-76: A scenario demonstrating Web Application Proxy on Windows Server 2016

In this scenario, a user on a nondomain-joined machine named CLT01 will be connecting to Outlook Web App by using the URL `https://mail.contoso.com/owa`. The user's request is sent over the external network to a Routing and Remote Access Server (RRAS01), which provides external DNS resolution for the zone `contoso.com` and routes traffic to the Contoso internal network for outside users. RRAS01 routes the request for

https://mail.contoso.com/owa into Contoso's internal network to the Web Application Proxy server (WAP01), which is running Windows Server 2016.

On WAP01, Outlook Web App has been published using AD FS preauthentication. In fact, a number of different Exchange services have been published using AD FS preauthentication or pass-through authentication, as demonstrated in Figure 2-77.



The screenshot shows the 'PUBLISHED WEB APPLICATIONS' interface. At the top, it says 'All published web applications | 6 total'. Below this is a search filter box. The main content is a table with four columns: Name, External URL, Backend Server URL, and Preauthentication. The 'Autodiscover' row is highlighted in blue.

Name	External URL	Backend Server URL	Preauthentication
Autodiscover	https://mail.contoso.com/autodis...	https://mail.contoso.com/autodis...	Pass-through
ECP	https://mail.contoso.com/ecp/	https://mail.contoso.com/ecp/	AD FS
Exchange Web Services	https://mail.contoso.com/ews/	https://mail.contoso.com/ews/	Pass-through
OAB	https://mail.contoso.com/oab/	https://mail.contoso.com/oab/	Pass-through
Outlook Anywhere	https://mail.contoso.com/rpc/	https://mail.contoso.com/rpc/	Pass-through
Outlook Web App	https://mail.contoso.com/owa/	https://mail.contoso.com/owa/	AD FS

Figure 2-77: Published web applications

In this case, we are assuming that this is a split DNS configuration and that internal and external DNS resolve the name mail.contoso.com to different IP addresses, depending on the user's location. Thus, the External URL value and Backend Server URL value are the same, but they could be different, as we'll show later. So, when a user who is on the internal Contoso network goes to https://mail.contoso.com/owa,

authentication takes place by using Windows Integrated Authentication. This requires that the URLs for mail.contoso.com and adfs.contoso.com are defined in the Trusted Zone for Local Intranet in Internet Explorer. If that is done, the user should be able to connect to his mailbox and not be prompted for authentication at all.

On the other hand, a user connecting from outside the corporate network is presented with a form-based authentication webpage, such as that shown in Figure 2-78, and is required to provide sign-in credentials.

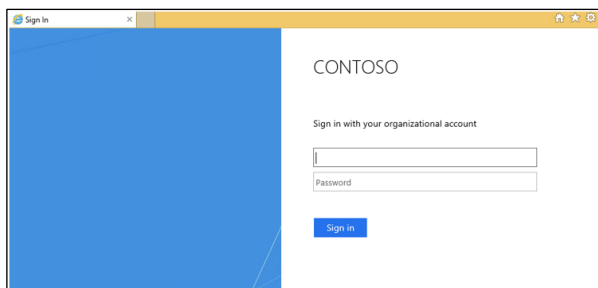

Figure 2-78: A form-based authentication page

However, one very important service used extensively in nearly every organization is missing—Microsoft Server ActiveSync. You could define a relying party trust for ActiveSync and set it up for pass-through authentication; this is what you would have done in Windows Server

2012 R2 Web Application Proxy. But, as noted earlier in this chapter, Web Application Proxy in Windows Server 2016 now supports the use of HTTP Basic clients for services such as ActiveSync that don't support redirection and that use HTTP Basic to authenticate users.

HTTP Basic is the authorization method used by many protocols, including ActiveSync, to connect rich clients, including smartphones, with an Exchange mailbox. (For more information on HTTP Basic, see RFC 2617 at <http://www.ietf.org/rfc/rfc2617.txt>.) Web Application Proxy traditionally interacts with AD FS using redirections, which is not supported on ActiveSync clients. Publishing an app by using HTTP Basic provides support for ActiveSync clients in Web Application Proxy by making it possible for the HTTP app to receive a nonclaims relying party trust for the application to AD FS.

The authentication flow for clients that use HTTP Basic is described in the following steps:

1. The user attempts to access a published web application through a telephone client.
2. The app sends an HTTPS request to the URL published by Web Application Proxy.

3. If the request does not contain credentials, Web Application Proxy returns an HTTP 401 response to the app containing the URL of the authenticating AD FS server.
4. The user sends the HTTPS request to the app again with authorization set to Basic and user name and Base 64 encrypted password of the user in the www-authenticate request header.
5. Because the device cannot be redirected to AD FS, Web Application Proxy sends an authentication request to AD FS with the credentials that it has: user name, password, and, if available, device certificate. The token is acquired on behalf of the device.
6. To minimize the number of requests sent to the AD FS, Web Application Proxy validates subsequent client requests by using cached tokens for as long as the tokens are valid. Web Application Proxy periodically cleans the cache. You can view the size of the cache by using the performance counter.
7. If the token is valid, Web Application Proxy forwards the request to the server backing the service and the user is granted access to the published web application.

To do this, go back to the ADFS01 server and create a nonclaims-aware relying party for ActiveSync, as depicted in Figure 2-79.

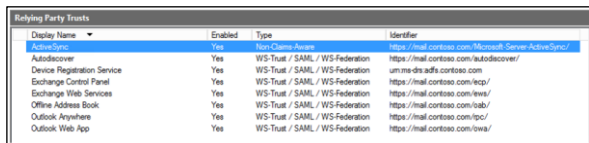

Display Name	Enabled	Type	Identifier
ActiveSync	Yes	Non-Claims-Aware	https://mail.contoso.com/Microsoft-Server-ActiveSync/
Autodiscover	Yes	WS-Trust / SAML / WS-Federation	https://mail.contoso.com/autodiscover/
Device Registration Service	Yes	WS-Trust / SAML / WS-Federation	um-ms-dfs.adfs.contoso.com
Exchange Control Panel	Yes	WS-Trust / SAML / WS-Federation	https://mail.contoso.com/ecp/
Exchange Web Services	Yes	WS-Trust / SAML / WS-Federation	https://mail.contoso.com/ews/
Offline Address Book	Yes	WS-Trust / SAML / WS-Federation	https://mail.contoso.com/oab/
Outlook Anywhere	Yes	WS-Trust / SAML / WS-Federation	https://mail.contoso.com/ipc/
Outlook Web App	Yes	WS-Trust / SAML / WS-Federation	https://mail.contoso.com/owa/

Figure 2-79: Relying party trusts

Next, go to the WAP01 server, publish the ActiveSync application by using HTTP Basic, and then select the ActiveSync nonclaims-aware relying party, as shown in Figure 2-80.

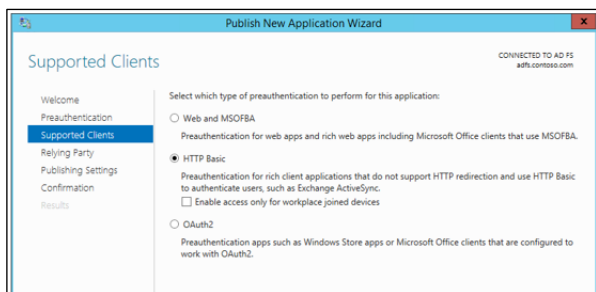

Figure 2-80: Supported clients

Note that this relying party is visible only when a nonclaims-aware relying party has been defined on the AD FS server, as demonstrated in Figure 2-81.

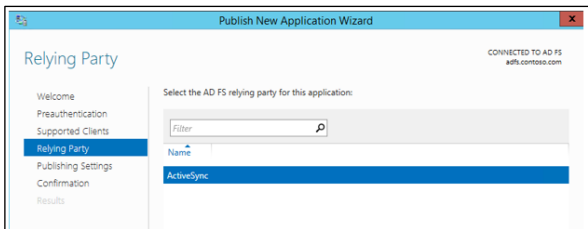

Figure 2-81: Relying party options

Complete the remainder of the wizard, configuring the external and server URL backing the service. The end result is shown in Figure 2-82.

PUBLISHED WEB APPLICATIONS
All published web applications | 8 total

Name	External URL	Backend Server URL	Preauthentication
APP01	https://www.contoso.com/app01/	https://apps.contoso.com/app01/	AD FS
Autodiscover	https://mail.contoso.com/autodis...	https://mail.contoso.com/autodis...	Pass-through
ECP	https://mail.contoso.com/ecp/	https://mail.contoso.com/ecp/	AD FS
Exchange Web Services	https://mail.contoso.com/ews/	https://mail.contoso.com/ews/	Pass-through
Microsoft ActiveSync	https://mail.contoso.com/Microso...	https://mail.contoso.com/Microso...	AD FS for Rich Clients
OAB	https://mail.contoso.com/oab/	https://mail.contoso.com/oab/	Pass-through
Outlook Anywhere	https://mail.contoso.com/rpc/	https://mail.contoso.com/rpc/	Pass-through
Outlook Web App	https://mail.contoso.com/owa/	https://mail.contoso.com/owa/	AD FS

Figure 2-82: All published web applications

Notice that the Microsoft ActiveSync published application uses the AD FS For Rich Clients preauthentication method.

Defining the claims

Although defining claims isn't a function of the Web Application Proxy role in Windows Server 2016, it's important to understand the role that claims play in a transaction. Claims are defined in the Outlook Web App section of the Actions pane on the AD FS server, as shown in Figure 2-83.

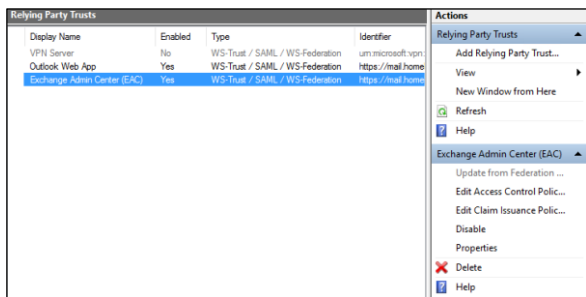

Figure 2-83: Editing claim rules

Select the relying party trust that you want to define claims for, and then, in the Actions pane, click Edit Claims.

In a claims-based identity model, AD FS issues a token that contains a set of claims. Claims rules govern the decisions with regard to the claims that AD FS issues. Claim rules and all server configuration data are stored in the AD FS configuration database.

To publish Outlook Web App and the Exchange Admin Center in this example, you need to make three custom claim rules:

- Active Directory user SID
- Active Directory group SID
- Active Directory UPN

When you configure the custom claims rules, you need to use the claim rule language syntax for this rule. Specifically, for the `ActiveDirectoryUserSID` claim rule, use the following:

```
c:[Type ==  
"http://schemas.microsoft.com/ws/2008/06/identity/claims/windowsaccountname",  
    Issuer == "AD AUTHORITY"]=> issue(store =  
"Active Directory",  
    types =  
("http://schemas.microsoft.com/ws/2008/06/identity/claims/primarysid"),  
    query = ";objectSID;{0}", param = c.Value);
```

When you are finished, the resulting rule will include the claim rule name and custom rule text, as depicted in Figure 2-84.

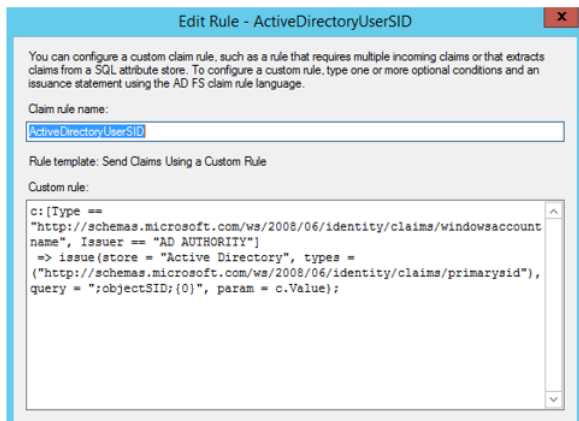

Figure 2-84: Editing a claim rule

Next, configure the following ActiveDirectoryGroupSID claim rule:

```
c:[Type ==
"http://schemas.microsoft.com/ws/2008/06/identity/claims/windowsaccountname",
  Issuer == "AD AUTHORITY"]=> issue(store =
"Active Directory",
  types =
("http://schemas.microsoft.com/ws/2008/06/identity/claims/groupsid"),
  query = ";tokenGroups(SID);{0}", param =
c.Value);
```

And finally, configure the following ActiveDirectoryUPN claim rule:

```
c:[Type ==
"http://schemas.microsoft.com/ws/2008/06/identity/claims/windowsaccountname",
```

```
Issuer == "AD AUTHORITY"]=> issue(store =  
"Active Directory",  
  types =  
("http://schemas.xmlsoap.org/ws/2005/05/identity/cla  
ims/upn"),  
  query = ";userPrincipalName;{0}", param =  
c.Value);
```

When you're finished, click Apply, and then OK. The transform rules display the rule names on the Issuance Transform Rules tab of the Edit Claim Rules dialog box, as shown in Figure 2-85.

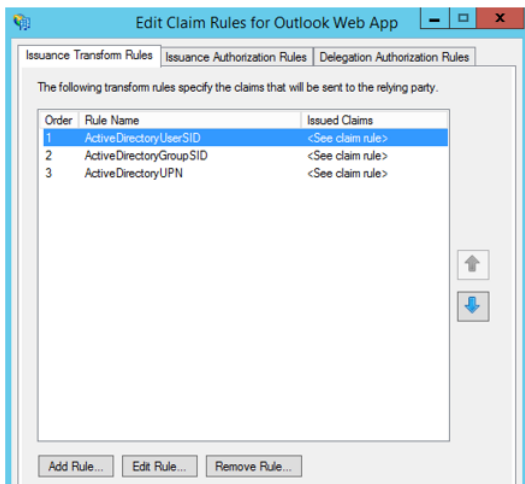
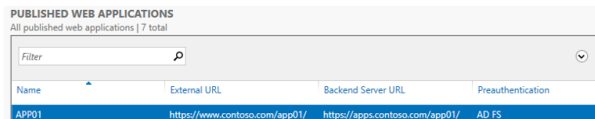

Figure 2-85: The Edit Claim Rules dialog box

Note You will need to do this for each of your relying party trusts.

URL hostname translation

Another thing to keep in mind is that Web Application Proxy can translate host names in URLs. For example, you might have an application that your external users access by using the URL `http://www.contoso.com/app01`, whereas your internal users get to the same app by going to `http://apps.contoso.com/app01`. This is perfectly acceptable, and Web Application Proxy can handle the difference in the URL, as illustrated by Figure 2-86, in which the external URL is `http://www.contoso.com/app01` and the Backend Server URL is `http://apps.contoso.com/app01`.



The screenshot shows a web interface titled "PUBLISHED WEB APPLICATIONS" with a sub-header "All published web applications | 7 total". Below the title is a search filter box. A table below the filter displays the following data:

Name	External URL	Backend Server URL	Preauthentication
APP01	https://www.contoso.com/app01/	https://apps.contoso.com/app01/	AD FS

Figure 2-86: Published web applications

Note You cannot change the path to be `http://www.contoso.com/app1` externally and `http://apps.contoso.com/applicationXYZ` internally.

This is valuable to know when publishing Exchange, because you can have different DNS namespaces for internal and external access. Therefore, you might want to publish a URL for

Outlook Web App that is different for your internal users than the one you publish for external access. Figure 2-87 shows that Web Application Proxy can accommodate this need as long as you keep the same path name.

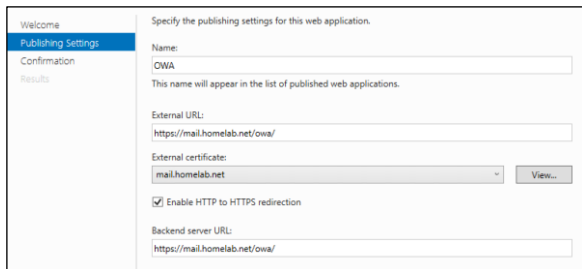

The screenshot shows the 'Publishing Settings' page for a web application. The left sidebar has 'Publishing Settings' selected. The main area is titled 'Specify the publishing settings for this web application.' and contains the following fields and options:

- Name:** OWA (Text input field)
- External URL:** https://mail.homelab.net/owa/ (Text input field)
- External certificate:** mail.homelab.net (Dropdown menu with a 'View...' button)
- Enable HTTP to HTTPS redirection**
- Backend server URL:** https://mail.homelab.net/owa/ (Text input field)

Figure 2-87: The publishing settings for an app

To allow this type of translation, you first must get the ID of the application for which you want to implement translation. To do this, you can use the following Windows PowerShell command:

```
Get-WebApplicationProxyApplication | Format-Table ID, Name, ExternalURL
```

Figure 2-88 presents the output that results.

```
PS C:\Users\administrator.CONTOSO> Get-WebApplicationProxyApplication | Format-Table ID, Name, ExternalURL
ID                                     Name                                     ExternalURL
--                                     -
E8700EC6-9BFF-5BE8-452F-50E9553E901D Outlook Web App                         https://mail.contoso.com/owa/
PS C:\Users\administrator.CONTOSO>
```

Figure 2-88: Output for Get-WebApplicationProxyApplication

Next, take the application ID from the output shown in Figure 2-88 and then enter the following Windows PowerShell command:

```
Set-WebApplicationProxyApplication -ID  
<application_ID>  
-DisableTranslateUrlInRequestHeaders:$false
```

Enabling AD FS for your Exchange organization

When you are configuring AD FS for claims-based authentication with Outlook Web App and the Exchange Admin Center in Exchange 2013, you must turn on AD FS for your Exchange organization. You can do this by using the Set-OrganizationConfig cmdlet for your organization. For the example environment in this chapter, you would need to do the following:

- Set the AD FS issuer to <https://adfs.contoso.com/adfs/ls>.
- Set the AD FS URIs to <https://mail.contoso.com/owa> and <https://mail.contoso.com/ecp>.
- Find the AD FS token signing certificate thumbprint by using the Windows PowerShell Get-ADFSCertificate -CertificateType "Token-signing" cmdlet on

the AD FS server. Then, assign the token-signing certificate thumbprint that you found.

Using the Exchange Management Shell, type the following code:

```
Get-ADFSertificate -CertificateType "Token-signing"
```

This will provide you with the token-signing certificate's thumbprint, on which you run the following Set-OrganizationConfig cmdlets:

```
$uris = @"  
https://mail.contoso.com/owa", "https://mail.contoso.  
com/ecp"  
Set-OrganizationConfig -AdfsIssuer  
"https://adfs.contoso.com/adfs/ls/" -  
AdfsAudienceUri $uris  
-AdfsSignCertificateThumbprint  
"1a2b3c4d5e6f7g8h9i10j11k12l13m14n15o16p17q"
```

Web Application Proxy troubleshooting

The sections that follow provide a few tips on how you can troubleshoot issues that might arise in environments in which Web Application Proxy has been deployed.

Collecting information about your environment

Managing and troubleshooting Web Application Proxy servers requires a good knowledge of Windows PowerShell and the cmdlets exposed for Web Application Proxy. When you are troubleshooting a Web Application Proxy problem, first take note of any error messages that appear in the console. If there aren't any obvious errors, review the event logs. You can sign in to each server and check the event logs, but you can use Windows PowerShell to simplify the process.

For example, the following Windows PowerShell command will gather all the events that the Web Application Proxy server generated in the previous 24 hours, along with their ID, Level, and Message:

```
$yesterday = (Get-Date) - (New-TimeSpan -Day 1) ;  
Get-WinEvent -FilterHashTable @{LogName='Microsoft-  
Windows-WebApplicationProxy/Admin';  
StartTime=$yesterday} | group -Property  
ID,LevelDisplayName,Message -NoElement |  
sort Count, Name -Descending | ft - Name -  
HideTableHeaders }
```

Suppose that you see Event ID 12000 repeatedly on this specific server; however, you have a number of Web Application Proxy servers, and you want to see if they are all experiencing the

same error. Run the following command to collect all the event ID 12000s generated within the previous 10 hours for a set of Web Application Proxy servers:

```
Foreach ($Server in
(gwpc).ConnectedServersName){Get-WinEvent -
FilterHashTable @{LogName='Microsoft-Windows-
WebApplicationProxy/Admin'; ID=12000;
StartTime=(Get-Date) - (New-TimeSpan -hour 10)} -
ComputerName $Server -ErrorAction SilentlyContinue |
group MachineName -NoElement | ft Name -
HideTableHeaders }
```

Now you have the list of all the servers experiencing the issue. For this example, let's assume that there is only one server experiencing this error.

The TechNet table of error codes can be very useful for resolving the issue (<http://technet.microsoft.com/en-us/library/dn770156.aspx>). The table on TechNet suggests checking the connectivity with AD FS for this particular Web Application Proxy server. To do so, go to <https://<FQDN of AD FS Proxy>/FederationMetadata/2007-06/FederationMetadata.xml> and ensure that there is a trust relationship between the AD FS server and the Web Application Proxy server. If this doesn't work, run the `Install-WebApplicationProxy` cmdlet to correct the issue.

Using the Microsoft Exchange Best Practices Analyzer

You can also run the Exchange Best Practices Analyzer on the Web Application Proxy server. You can do this via the Server Manager GUI. In the far left pane, select Local Server and then scroll down to Best Practices Analyzer in the middle pane, as shown in Figure 2-89.

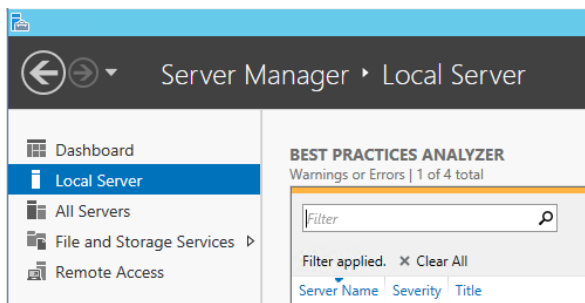

Figure 2-89: Best Practices Analyzer in Server Manager

On the right side of the Server Manager GUI, click Tasks and then select Start BPA Scan, as depicted in Figure 2-90.

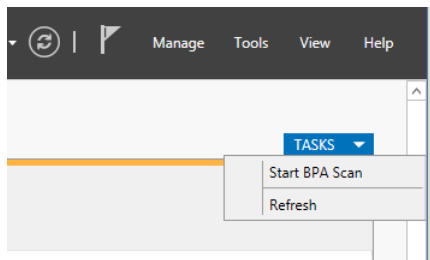

Figure 2-90: Starting a BPA Scan

You also can run the Best Practices Analyzer by using the following Windows PowerShell cmdlet:

```
Invoke-BpaModel Microsoft/Windows/RemoteAccessServer
Get-BpaResult Microsoft/Windows/RemoteAccessServer
```

In this case, there is an issue related to certificate problems specifically (Figure 2-91); an error message appears stating, "Web Application Proxy could not publish an application due to certificate problems."

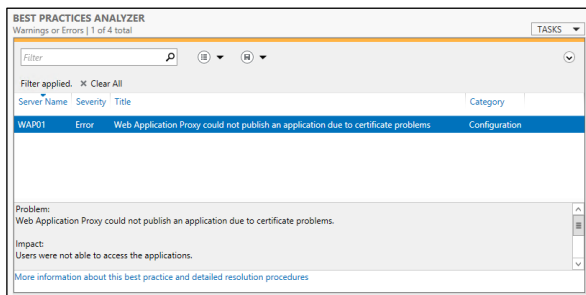

Figure 2-91: Viewing the Best Practices Analyzer results

The event listed in the Best Practices Analyzer pane provides details that will help you to resolve the issue, as shown in Figure 2-92.

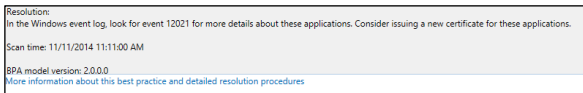

Figure 2-92: Viewing details from the Best Practices Analyzer

The table on TechNet offers the following suggestion for event 12021:

Make sure that the certificate thumbprints that are configured for Web Application Proxy applications are installed on all the Web Application Proxy machines with a private key in the local computer store.

Armed with this information, you can review the certificates on the Web Application Proxy server to ensure that they have the correct names and expiration dates, and that the thumbprint matches the one on the server. Then, you can review the certificates on the server, ensure that they are correct, and reissue them if they are incorrect.

Certificate issues

Certificates play an important role in AD FS and Web Application Proxy. Getting the proper certificates—with the correct names in the certificates on the appropriate machines—is therefore critical to getting Web Application Proxy to function correctly with AD FS.

You might see issues with certificates manifested in error messages like the following:

```
The trust certificate ("ADFS ProxyTrust - WAP01") is not valid.
```

There are several possible causes of this issue:

- There might be some sort of network interruption between the Web Application Proxy server and the AD FS server.
- The Web Application Proxy server might have been down for an extended period of time.
- There might be an issue validating the certificate due to problems in the CA infrastructure.
- Time synchronization issues between the Web Application Proxy and AD FS servers might cause them to be out of synchronization.

To resolve these problems, verify the time settings on the Web Application Proxy and AD FS servers and then rerun the `Install-WebApplicationProxy` cmdlets.

Configuration data in AD FS is inconsistent or corrupt

You might also encounter errors for which the configuration data in AD FS could not be found or the data is unusable to the Web Application Proxy server. This can result in errors such as

Configuration data was not found in AD FS.

or

The configuration data stored in AD FS is corrupted or Web Application Proxy was unable to parse it.

or:

Web Application Proxy was unable to retrieve the list of Relying Parties from AD FS.

Several things can cause these errors. It's possible that Web Application Proxy was never fully installed and configured, or there were changes that occurred on the AD FS database that resulted in corruption. It's also possible that the AD FS server cannot be reached due to a network issue and therefore the AD FS database is not readable.

There are several paths to resolution for these types of errors:

- Run the `Install-WebApplicationProxy` cmdlet again to clear up configuration issues.
- Confirm network connectivity to the AD FS server from the Web Application Proxy server.
- Verify that the `WebApplicationProxy` service is running on the Web Application Proxy server.

Supporting non-SPI-capable clients

Server Name Indication (SNI) is a feature of Secure Sockets Layer (SSL) Transport Layer Security (TLS) that is used in Web Application Proxy server and AD FS to reduce network infrastructure requirements. Traditionally, an SSL certificate had to be bound to an IP address/port combination. This meant that you would need to have a separate IP address configured if you wanted to bind a different certificate to the same port number on a server. With the use of SNI, a certificate is instead bound to the host name and port, allowing you to conserve IP addresses and reduce complexity.

It's important to realize that SNI relies on the requesting client supporting SNI. If the SSL Client

Hello doesn't contain the SNI header, http.sys won't be able to determine which certificate to offer the client and will reset the connection.

Most modern clients support SNI, but there are some clients that tend to cause issues. Generally, older browsers, legacy operating systems, hardware load balancers, health probes, older versions of WebDAV, ActiveSync on Android, and some older VoIP conferencing devices might be non-SNI-capable devices.

If it is necessary to support non-SNI clients, the easiest solution is to create a fallback certificate binding in http.sys. The fallback certificate needs to include any fully qualified domain names (FQDNs) that may need to be supported, including the FQDN for the AD FS service itself (adfs.contoso.com), the FQDN of any applications published via Web Application Proxy (mail.contoso.com), and the FQDN to support Enterprise registration (enterpriseregistration.contoso.com) if you are using Workplace Join.

When you have generated the certificate, get the application GUID and certificate thumbprints in use by using the following Windows PowerShell cmdlet:

```
Get-WebApplicationProxyApplication | fl  
Name,ExternalURL,ExternalCertificateThumbprint
```

Now that you have the application GUID and certificate thumbprint, you can bind it to the IP wildcard and port 443 by using the following syntax:

```
netsh http add sslcert ipport=0.0.0.0:443  
certhash=certthumbprint appid={applicationguid}
```

Note that you will need to run this on each server in the AD FS farm as well as on any Web Application Proxy server.

More info You can find technical details on SNI as a subsection of the TLS Extensions RFC at <https://tools.ietf.org/html/rfc3546#section-3.1>.

Hear about it first.



Get the latest news from Microsoft Press sent to your inbox.

- New and upcoming books
- Special offers
- Free eBooks
- How-to articles

Sign up today at
MicrosoftPressStore.com/Newsletters



Application platform

In this chapter, we explore how Microsoft has made a focused shift to ensuring that customers today, whether they are in the public or private cloud, have a solid foundation for their application portfolio. We discuss two new technologies introduced in Microsoft Windows Server 2016: *Nano Server* and *containers*. With these new technologies, you can take advantage of a highly optimized, scalable, and secure experience for Application Platform.

Modernizing traditional apps

The cloud makes it possible for businesses to innovate quickly and deliver faster time-to-value with cloud-native applications and microservices architecture. But most businesses are grappling with how to manage and update thousands of existing applications while planning how to move to this new world. What is needed is a solution that helps you invigorate existing applications and create new, cloud-native applications. Windows Server 2016 can do both.

Windows Server helps you to secure and modernize existing enterprise server apps with little or no code changes; package existing apps in containers to realize the benefit of a more agile DevOps model; and then deploy either on-premises, to any cloud, or in a hybrid model. Developers can create cloud-ready, business-changing apps and services, whether on-premises or in any cloud, using technologies such as containers and the lightweight Nano Server installation option.

Windows Server 2016 can help you modernize your apps and innovate faster with a cloud-ready application platform. Figure 3-1 highlights the

areas where you can take advantage of the technology today in Windows Server 2016 to move forward and be cloud ready or cloud native.

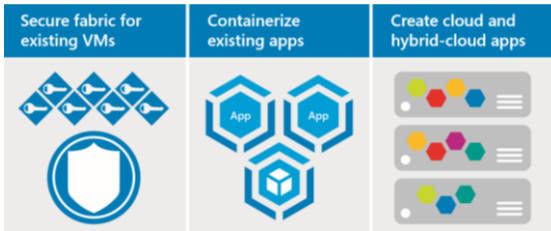

Figure 3-1: Diagram showing the three pillars for an application platform

First, you can secure the fabric to protect virtual machines (VMs) and enhance existing apps immediately with Windows Server 2016, by taking advantage of enhanced security and management features in the fabric. For example, you can use shielded VMs to help secure your critical applications to run only on trusted fabrics. You can limit administrator access to specific tasks by using Just Enough Administration (JEA) and specific time limits with Just-in-Time (JIT) administration.

More info For more detail about shielded VMs, JEA, and JIT administration, read the discussion in Chapter 4.

Second, you can containerize existing apps and move your traditional applications into a modern DevOps environment with little or no code changes. You can gain benefits such as consistency across development, test, and production by using the same tooling, which facilitates rapid deployments, continuous integration, and continuous delivery, all with better security. You can use containers to gain control and consistency by enabling apps that you can deploy on-premises, to any cloud, or in a hybrid architecture across clouds. For an additional layer of isolation, you can deploy your app in a Hyper-V Container, which packages the same container image in a Hyper-V Container, which uses the hypervisor to provide an additional level of isolation.

Third, you can build cloud-native and hybrid apps. Windows Server 2016 is suited to Agile methods for building cloud-native applications with microservices architectures. With Nano Server's deployment model, you can build offline customized operating system (OS) images highly optimized for your application, providing a fast-booting, tiny OS that achieves higher density while exposing a reduced attack surface.

Microsoft wants you to create your best app, whether it's written by using the Microsoft .Net

Framework or open-source frameworks such as .Net Core and Node.JS. Using proven Microsoft Azure Service Fabric technology along with Windows Server 2016, you can build always-on, scalable, and distributed applications and run them in Azure, on-premises, or in a hybrid environment. You can combine the benefits of containers with Nano Server, Service Fabric, and the proven Windows Server platform to achieve business agility with cloud apps.

Ultimately, the choice will depend on each customer's needs and the application being developed, but Windows Server 2016 offers multiple options with which you can move forward into a cloud-ready infrastructure with minimal investment.

Microservices

When it came to applications built for the web, we generally moved away from traditional *n*-tier architectures toward Services-Oriented Architecture (SOA). This was no easy task and put a lot of customers off rewriting their applications. SOA breaks down an application into components, which communicate with one another via some communication protocol.

It could be said that SOA is the forefather of microservices, given that microservices breaks down even further to smaller components that each live and run as an individual process and communicate with one another in a language-agnostic fashion.

Microservices foster more rapid development versus SOA. This is because the components that dictate a microservices model are far smaller than SOA. If you need to make a change to a component in microservices, you can develop, update, and deploy rapidly without affecting the operation of the other components. Each component is technically an independent contractor, so each has its own way of doing things and separate way of communicating. Because all of these components share a single communication model, this makes it simpler to improve parts of an application built on microservices.

Service Fabric is a distributed systems platform that makes building microservices or translating your application into microservices architecture easy to do, while also giving you the means to manage the full lifecycle of an application. It is available both on-premises and in Azure as Azure Service Fabric. You can write an application once and deploy it on-premises or to

Azure with no API change using, all while using common development tools like Microsoft Visual Studio.

Service Fabric powers many Microsoft services today, including Azure SQL Database, Azure DocumentDB, Cortana, Power BI, Intune, Azure Event Hubs, Azure IoT, Skype for Business, and many other core Azure services. All the learnings from running these solutions have been incorporated into the Service Fabric product and will ensure that if your applications need a highly reliable and scalable solution, this is your microservices platform of choice.

More info To learn more about Service Fabric and what it can do for you, go to <https://azure.microsoft.com/documentation/articles/service-fabric-overview/>.

Azure Hybrid Use Benefit

As we previously mentioned, Windows Server 2016 will help you in countless ways when it comes to your journey to the cloud. Microsoft has also built a licensing offer to support this journey so that you can truly maximize the benefit of your on-premises licenses and use them in Azure to help you control costs while running in a public cloud.

Azure Hybrid Use Benefit (AHUB) gives customers who are using Windows Server with Software Assurance a mechanism to bring those licenses to Azure. This means a reduced rate can be applied to their Windows Server Virtual Machines running Azure. Essentially, you are paying just for the base compute rate, which can equate up to a 41 percent savings on a D2 VM.

More info For more information about AHUB, go to <http://azure.microsoft.com/pricing/hybrid-use-benefit>.

Nano Server

Nano Server is an exciting new installation option for Windows Server 2016 that has an even smaller footprint than the Server Core installation option.

Understanding Nano Server

Nano Server is a new, small-footprint, headless installation option for Windows Server 2016. It is a deep refactoring of Windows Server that is optimized for the cloud. As such, Nano Server in Windows Server 2016 is ideal for the following scenarios:

- Compute Host for Hyper-V or part of a Windows Failover Cluster
- Container Host
- Storage Host for a Scale-Out File Server (SOFS)
- DNS server
- Web server running IIS
- Application Platform for apps that are built using cloud development patterns and run in a container and/or VM guest

Nano Server is fully headless; thus, it might require some changes to management and operations procedures for organizations that aren't fully managing their current server deployments remotely.

Windows Server customers have provided this feedback:

- Reboots have a negative impact on my business—why do I need to reboot because of a patch to a feature I never use?
- When a reboot is required, my servers need to be back in service as soon as possible.

- Large server images take a long time to deploy and consume a lot of network bandwidth.
- If the operating system consumes fewer resources, I can increase my virtual machine density.
- We can no longer afford the security risks of the "install everything everywhere" approach.

Nano Server addresses these problems by including just the functionality required for its proposed use cases and nothing more. This minimizes the attack surface area, thus eliminating reboots and minimizing the footprint, which provides faster deployment and reboot time and frees up resources for other uses.

Security improvements

Eliminating installed-by-default functionality from Nano Server also reduces the number of drivers, services, and ports open, as shown in Figure 3-2.



Figure 3-2: Default functionality comparison between Nano Server and Server Core

Resource utilization

Minimizing the resources utilized by Nano Server frees resources that can be used to increase VM density. It also improves boot performance when reboots are required, as demonstrated by Figure 3-3.

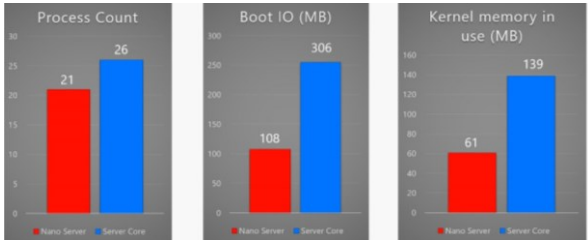

Figure 3-3: Resource utilization comparison between Nano Server and Server Core

Deployment improvements

Setup time, including specialization, for Nano Server is significantly less than for Server Core, as is the footprint (see Figure 3-4). This provides fast deployments with less to copy over the network when redeploying, reducing the network bandwidth for deployments that must be accounted for in overall capacity.

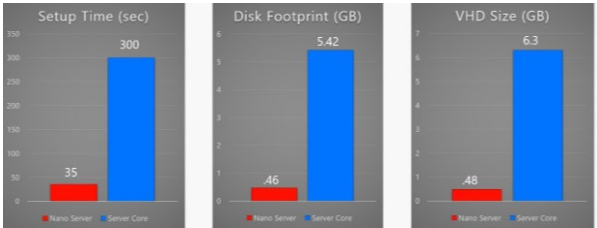

Figure 3-4: Deployment requirements comparison between Nano Server and Server Core

Server Core pattern

Figure 3-5 shows how Nano Server will be a separate installation option from the other server installation options in Windows Server 2016, much as Server Core was in Windows Server 2008 and Windows Server 2008 R2.

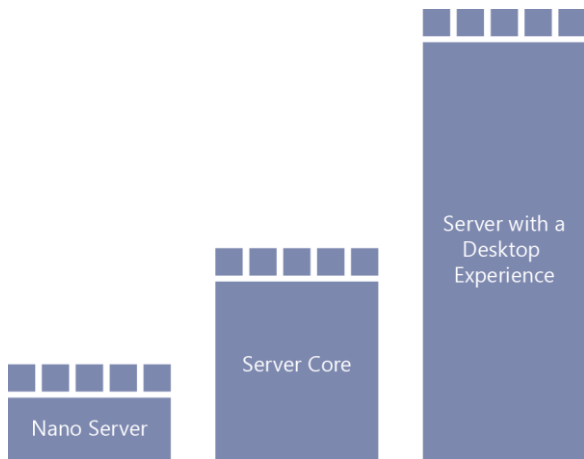

Figure 3-5: Architecture of different installation options for Windows Server 2016

Note Moving between Nano Server and the other installation options will require reinstallation.

Deploying Nano Server

Nano Server is a new installation option for Windows Server 2016; however, unlike Server Core, it does not appear as an option when you run setup. This is because Nano Server requires that you customize the image for your hardware and the role it will play before deploying, as is

discussed further later in the chapter. You can find Nano Server on the Windows Server 2016 media, in the \NanoServer folder; all of the packages that you can install on Nano Server are in \NanoServer\Packages or available from an online repository.

More info For the latest information regarding Nano Server deployment, see the Nano Server guide at <https://msdn.microsoft.com/library/mt126167.aspx>.

Drivers

Because Nano Server does not have user-mode plug-and-play, it is necessary for you to add the drivers for your hardware to the Nano Server image before you deploy it. Nano Server uses the same drivers as Windows Server, so you can use any supported hardware that has a driver for Windows Server with Nano Server, including the following:

- Network adapters
- Storage controllers
- Disk drives

Although there is no need for a special Nano Server version of the driver, if the hardware requires a special tool for configuration and the current tool does not work remotely, the hardware vendor will need to provide an updated tool or instructions for configuration on Nano Server.

Note You add drivers to the Nano Server image by using using the `NewNanoServerImage` script.

Roles and features

Nano Server also separates the package store from the image. Therefore, none of the role or feature binaries are in the WinSXS folder when Nano Server is deployed; you must add them to the image prior to deploying Nano Server. This makes it possible for you to configure the deployed Nano Server image with just what is necessary for the role of the server.

Note You install roles and features by using the `NewNanoServerImage` cmdlet.

Additional roles will be added over time. You can check to validate what are the latest roles added to Nano Server Support at

<https://msdn.microsoft.com/library/mt126167.aspx>.

Applications

Nano Server has several proven scenarios as we have discussed, but what about running applications on Nano Server as a guest VM or container workload? This would reduce the footprint required and mitigate a broad number of potential security threats. The big question is how do we get an application into Nano Server?

Remember, Nano Server is a deeply refactored version of Windows, and hence if there are components that your application depends on (i.e., GUI components), not included in Nano Server, it will not run and you will need to refactor the application to support Nano Server.

More info For some background reference, you can find a walkthrough example for developing an application on Nano Server at <http://blogs.technet.microsoft.com/nanoserver/2016/04/27/developing-native-apps-on-nano-server> and <https://blogs.technet.microsoft.com/nanoserver/2016/04/27/nanoserverapiscan-exe-updated-for-tp5/>.

If you have refactored your application to be compatible with Nano Server, you can use a new

utility called Windows Server Apps (WSA) Installer to help you package an APPX package and install this on your Nano Server. APPX and WSA are a new framework for installing applications and overcoming some of the limitations we had with MSI Installer.

More info To learn more about installing Windows Server applications on Nano Server, go to <https://blogs.technet.microsoft.com/nanoserver/2015/11/18/installing-windows-server-apps-on-nano-server>.

Specializing Nano Server

Just like Server Core, you can use a subset of what is available via Unattend to specialize a Nano Server image. In an effort to further reduce the deployment time beyond just the smaller footprint, a couple of commonly used Unattend settings are available to set offline:

- Computer name
- Domain join using Djoin.exe

More info For information on how to perform an offline domain join using Djoin.exe, see <https://technet.microsoft.com/windows-server->

[docs/compute/nano-server/getting-started-with-nano-server](https://docs.microsoft.com/en-us/windows/nano-server/getting-started-with-nano-server).

When you deploy a Nano Server image with these settings configured in the offline section of the Unattend file, Nano Server is specialized on first boot. This eliminates the second boot that occurs with Server Core during specialization, further reducing deployment time.

Remotely managing Nano Server

Nano Server is truly headless—there is no way to use Remote Desktop to connect remotely. As a result, you must perform all Nano Server management remotely, either via Windows PowerShell, Windows Management Instrumentation (WMI), Windows Remote Shell (WinRS), Emergency Management Services (EMS), or remote GUI tools.

Note The options discussed in this section to remotely manage Nano Server are the same mechanisms that you can use to remotely manage Server Core. The only difference in managing Nano Server is that you must do it all remotely.

Windows PowerShell

Nano Server includes a refactored subset of Windows PowerShell called Core PowerShell, which is based on the CoreCLR. Core PowerShell provides the following:

- Full Windows PowerShell language compatibility
- Full Windows PowerShell remoting
- Most core engine features
- Support for all cmdlet types, including C#, Windows PowerShell, and CIM

Because Nano Server includes Core PowerShell, it is possible to use Windows PowerShell Remoting to manage Nano Server. To do so, you need to be an administrator on the Nano Server machine and add its IP address to the management machine's trusted hosts. To do that, from an elevated Windows PowerShell prompt, run the following command (which, for this example, assumes the Nano Server machine's IP address is 192.168.1.10):

```
PS C:\> Set-Item  
WSMan:\localhost\Client\TrustedHosts "192.168.1.10"
```

The following is an example of how to start an interactive remoting session:

```
PS C:\NanoServer> $ip = "192.168.1.10"  
PS C:\NanoServer> $user = "Administrator"  
PS C:\NanoServer> Enter-PSSession -ComputerName $ip  
-Credential $user
```

After you have done this, you can now run any available Windows PowerShell command as if you were entering it directly into the Nano Server console; for example:

```
[192.168.1.10]: PS C:\users\user1\Documents> Get-  
Process w*  
[192.168.1.10]: PS C:\users\user1\Documents>  
ipconfig /all
```

Not all Windows PowerShell commands are available in Nano Server. To see which cmdlets are available, run the following command:

```
[192.168.1.10]: PS C:\users\user1\Documents> Get-  
Command -CommandType Cmdlet
```

To end the remoting session, run this command:

```
[192.168.1.10]: PS C:\users\user1\Documents> Exit-  
PSSession
```

WMI

Nano Server includes WMI v1 and WMI v2 as well as the providers for the included functionality.

WinRM

You can use CIM sessions and CIM instances in Windows PowerShell to run WMI commands remotely over WinRM, as demonstrated here:

```
PS C:\NanoServer> $ip = "192.168.1.10"  
PS C:\NanoServer> $user = "Administrator"  
PS C:\NanoServer> $cim = New-CimSession -Credential  
$user -ComputerName $ip
```

When the CIM session is established, you can run various WMI commands, such as the following:

```
PS C:\NanoServer> Get-CimInstance -CimSession $cim -  
ClassName Win32_ComputerSystem | Format-List *  
PS C:\NanoServer> Get-CimInstance -Query "SELECT *  
from Win32_Process WHERE name LIKE 'p%'"
```

WinRS

Using Windows Remote Management (WinRM), you can run programs remotely. Before you can use WinRS, you need to configure the WinRM service and set the code page, as follows:

```
C:\NanoServer> winrm quickconfig  
C:\NanoServer> winrm set winrm/config/client  
@{TrustedHosts="*"}
```

After you configure the WinRM service, you can run commands remotely, as if you were running them from the command line:

```
C:\NanoServer> winrs -r:192.168.1.10 -  
u:Administrator -p:Tuva ipconfig
```

More info To learn more about about WinRS, go to <http://technet.microsoft.com/library/hh875630.aspx>.

EMS

EMS is yet another tool that you can use to remotely manage Nano Server by connecting a serial cable between the management machine and the Nano Server machine.

After you set up EMS in the Boot Configuration Data (BCD) settings for the Nano Server machine and start Nano Server, start a terminal emulator, such as PuTTY, from an elevated prompt on the management machine, and then complete the following steps:

1. Set the speed to the same baud rate you used in the Nano Server BCD.
2. Select Serial for Connection Type.
3. Enter the correct value for Serial Line.

Remote GUI tools

In addition to the command-line remote management options discussed in the previous sections, you can use many existing remote GUI tools to remotely manage Nano Server. Because

there is no local sign-in or Remote Desktop in Nano Server and there are tools that even in Server Core don't have remote GUI replacements, for example Task Manager, there are a set of web-based remote GUI called Server Management Tools available in Azure today. You can use these web-based remote GUI tools to manage Nano Server as well as Server Core and any of the other installation options.

More info For further information about the Server Management Tools, see Chapter 5.

Monitoring Nano Server

You can now monitor Nano Server by using System Center 2016 Operations Manager. This will require updated management packs, but it will be capable of monitoring the base Nano Server operating system, Failover Clustering, DNS, and IIS. Support for other roles will come via new management packs. The agent can be deployed remotely via the System Center 2016 Operations Manager Console.

Through the normal discovery wizard, you can push an agent to Nano Server. You also can configure Nano Server to forward its security-related events to the Audit Collector Service in System Center 2016 Operations Manager.

Nano Server Recovery Console

Nano Server includes a Recovery Console that ensures you can access your Nano Server even if a network misconfiguration interferes with connecting to the Nano Server. You can use the Recovery Console to fix the network and then use your usual remote management tools.

When you boot Nano Server in either a VM or a physical computer that has a monitor and keyboard attached, you'll see a full-screen, text-mode sign-in prompt. Sign in to this prompt with an administrator account to see the computer name and IP address of the Nano Server. You can use the following commands to navigate in this console:

- Use arrow keys to scroll
- Use Tab to move to any text that begins with ">"; then press Enter to select.
- To go back one screen or page, press Esc. If you're on the home page, pressing ESC will log you off.
- Some screens have additional capabilities displayed on the last line of the screen. For example, if you explore a network adapter, F4 will disable the network adapter.

Note The Recovery Console only supports basic keyboard functions. Keyboard lights, 10-key sections, and keyboard layout switching such as caps lock and number lock are not supported.

Service branching

In prior releases, Windows Server has been serviced and supported with a “5 + 5” model, meaning that there is five years of mainstream support and five years of extended support, and this will continue with Windows Server 2016. Customers that choose to install Windows Server 2016 with desktop experience or Server Core will maintain this servicing experience, this is now known as the Long-Term Servicing Branch (LTSB).

Customers choosing the Nano Server installation will opt into a more active servicing model similar to the experience with Windows 10. Specifically, these periodic releases are known as Current Branch for Business (CBB) releases. This approach supports customers that are moving at a “cloud cadence” of rapid development lifecycles and want to innovate more quickly.

Because this type of servicing continues to provide new features and functionality, Software Assurance is also required to deploy and operate Nano Server in production.

Installation option	LTSB servicing model	CBB servicing model
Server with Desktop Experience	Yes	No
Server Core	Yes	No
Nano Server	No	Yes

The goal is to provide feature updates approximately two or three times per year for Nano Server. The model will be similar to the Windows client servicing model, but we expect it to have some differences. Although we share the same goal of delivering new and valuable technology to our customers rapidly, we understand that a server operating environment has unique requirements.

For example, even though it will be necessary to stay current with new versions as they come out, the new versions will not auto-update a server.

Instead, the administrator will perform a manual installation when he chooses. Because Nano Server will be updated on a more frequent basis, customers can be no more than two Nano Server CBB releases behind. Only two CBB releases will be serviced at any given time; therefore, when the third Nano Server release comes out you will need to move off of release 1 because it will no longer be serviced. When release 4 comes out, you will need to move off of release 2, and so on.

Containers

By John McCabe

This section introduces a new technology to Windows Server 2016 called *containers*.

Containers come in two types:

- Windows Server Containers
- Hyper-V Containers

In this section, we explain what a container is and why is it important.

What is a container?

A container in its simplest form is exactly that—a container. It is an isolated environment in which

you can run an application without fear of changes due to applications or configuration. Containers share key components (kernel, system drivers, and so on) that can reduce startup time and provide greater density than you can achieve with a VM. Figure 3-6 shows an abstract of a container.

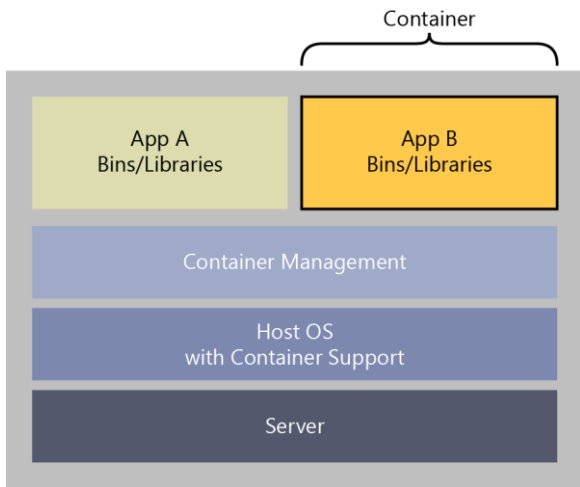

Figure 3-6: Conceptual container layout

As the illustration demonstrates, a host OS can host many containers and allow them to be completely isolated while sharing key components of the OS, such as the kernel.

The interesting thing about containers is the application itself. The application might have various dependencies that it requires to run. These dependencies exist only within the container itself. This means that something bad that happens to Application A and the binaries it depends on has no impact on Application B and the binaries on which it depends. For example, in most environments, if you delete the registry from Application A, the consequences are disastrous for both Application A and Application B. However, with containers, Application A and Application B are each self-contained, and the change to the registry for Application A does not affect Application B.

Because all binaries and dependencies are hosted within the container, the application running in the container is completely portable. Essentially, this means that you can deploy a container to any host running the container manager software, and it will start and run without any modification. For example, a developer can begin developing his application and deploy it into a Hyper-V Container using Windows 10 Anniversary Edition. When he is ready to roll it out in production, it can be run on Windows Server 2016, including Nano Server, in a public, private, or hybrid cloud.

Containers are built on layers. The first layer is the *base layer*. This is the OS image on which all other layers will be built. This image is stored in an image repository so that you can reference it when necessary. The next layer (and sometimes the final layer) is the *application framework layer* that can be shared between all of your applications. For example, if your base layer is Windows Server Core, your application framework layer could be .NET Framework and Internet Information Services (IIS). The second layer can also be stored as an image, which, when called, also describes its dependency on the base layer of Windows Server Core. Finally, the *application layer* is where the application itself is stored, with references to the application framework layer and, in turn, to the base layer.

The base layer and the application layer can be referenced at any time by any other application container you create. Each layer is considered read-only except the top layer of the “image” you are deploying. For example, if you deploy a container that depends only on the Windows Server Core image, this Windows Server Core layer is the top layer of the container and a sandbox is put in place to store all the writes and changes made during runtime. You can then store the changes made as another image for later reuse. The same applies if you deploy the

application framework layer image; this layer would have its own sandbox, and if you deploy your application to it, you can then save the sandbox as a reusable image.

Basically, when you deploy a container to a host, the host determines whether it has the base layer. If not, it pulls the base layer from an image repository. Next, it repeats the process for the application framework layer and then creates the application container that you were originally trying to deploy. If you then want to create another container with the same dependencies, you simply issue a command to create the new application container, and it is provisioned almost immediately because all of the dependencies are already in place. If you have an application container that depends on a different application framework layer as well as on the original Windows Server Core base layer, you can simply pull the different application framework layer from an image store and start the new application container.

Why use containers?

Containers provide some distinct advantages over the traditional VM model of deploying an application into a VM or onto a physical host.

The first advantage has to do with development. A general pain for developers when they are building applications revolves around moving the application from a development environment, to test, and then to production. Developers must spend a lot of time and effort checking the application's dependencies as it moves through the environments. However, when an application is deployed to a container, you can move the container between environments because it is isolated and all of the binaries reside within the container itself.

Another reason for using containers is to achieve higher scale versus deploying an application to a VM. To achieve the different environments of development, test, and production in a VM model, you need at least three VMs; in a container model you need only one. That single VM, running a container manager, can run three containers simulating development, test, and production environments. With containers, you need fewer VMs to run your environments and you can achieve significantly higher scale in your cloud environments.

Containers also allow for rapid deployment and operation of applications. Unlike VMs, containers don't have an underlying OS, as such. Think in terms of deployment. If you want to create a new

application or scale the existing application to support more load, you just load a new container; the OS is already in place. This means that the time spent waiting for a container to deploy or scale up is significantly shorter than with a VM because you are never waiting for the OS to start.

Windows Server containers versus Hyper-V containers

Two types of containers are available in Windows Server 2016:

- Windows Server Containers
- Hyper-V Containers

You can consider Windows Server containers to be the equivalent to Linux containers. Windows Server container types isolate applications on the same container host. Each container has its own view of the host system, including the kernel, processes, file systems, the registry, and other components. In the case of Windows Server containers, they work between the user mode level and the kernel mode level.

Hyper-V containers are based on a container technology that is rooted in hardware-assisted virtualization. With hardware-assisted

virtualization, Hyper-V containers' applications are provided a highly isolated environment in which to operate, where the host OS cannot be affected in any way by any running container.

Figure 3-7 shows what the layout might look like in relation to the two container technologies that are available in Windows Server 2016.

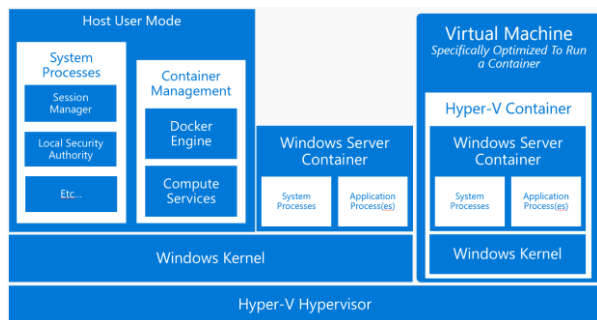

Figure 3-7: Windows Server 2016 containers and Hyper-V containers on the same physical box

As shown in the illustration, one physical host can offer a mix of Hyper-V containers, VMs, and Windows Server containers. With two potential container options, the question is when to use either Windows Server containers or Hyper-V containers for developing and deploying the applications. The deciding criteria come when you identify scale and hardware-assisted

isolation requirements for the application or customer using the containers.

For example, if you require greater scale, Windows Server containers are the best option because you can achieve this goal. However, if you require the isolation benefits of hardware-assisted virtualization, and scale is not as important, Hyper-V containers are the best option to use.

When looking at either type of containers, it is important to understand the development lifecycle. From a developer's perspective, the tools they are familiar with, such as Visual Studio, will allow them to write and deploy applications directly into containers. The tools will also give them the ability to describe what core functionality is required in the underlying OS, what libraries can be shared between applications, or what libraries are to be dedicated for a container. Figure 3-8 highlights the dependencies and runtime mode of the containers.

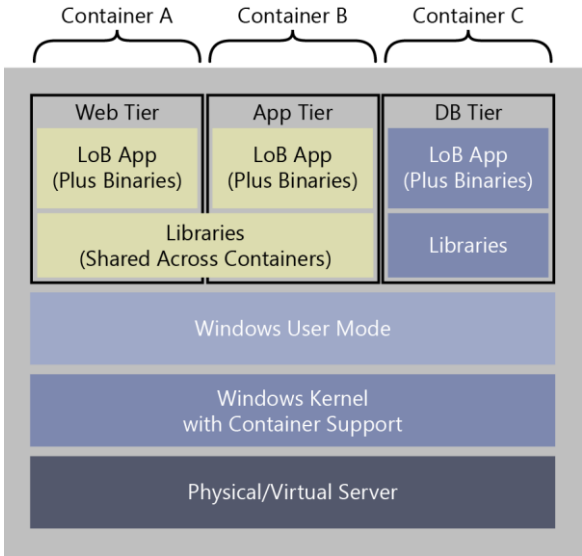

Figure 3-8: Containers and dependencies

No matter which technology you choose, the application you deploy into a container is compatible between both technologies. This essentially means that a developer can easily build the application in a container hosted on Windows Server containers and move it to a Hyper-V container with no changes required. This gives great flexibility, especially if the requirements of scale or isolation change after the initial planning of the system.

Container management

In 2015, Microsoft announced support for the Docker engine on Linux VMs in Azure. This was exciting news, but the question remains: What about Docker on Windows natively? With the introduction of Windows Server containers and Hyper-V containers, Docker becomes even more useful because you can use it to manage Docker containers on Windows as well as the traditional Linux environment. Also, we now have access to all of the images that are available through Docker, so we can download and deploy!

The Docker runtime engine works as an abstraction on top of Windows Server containers and Hyper-V containers. Docker provides all of the necessary tooling to develop and operate its engine on top of Windows containers, be it Hyper-V containers or Windows Server

containers. This will afford the same flexibility of developing an application in one container and being able to truly run it anywhere.

Figure 3-9 shows the placement of the Docker engine in relation to Windows Server containers or Hyper-V containers and compares it to a Docker engine running on Linux.

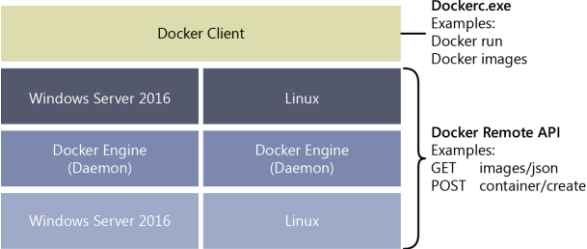

Figure 3-9: The Docker engine on Windows and Linux

The Docker engine runs at the same level in either a Windows Server container or Linux container environment, and it can run with Windows Server or Linux above the Docker engine. The Docker client will connect to any Docker engine and provide a consistent management experience for the end user.

The underlying principle is to minimize development time and truly impart a write-once, run-anywhere experience, as shown in Figure 3-10.

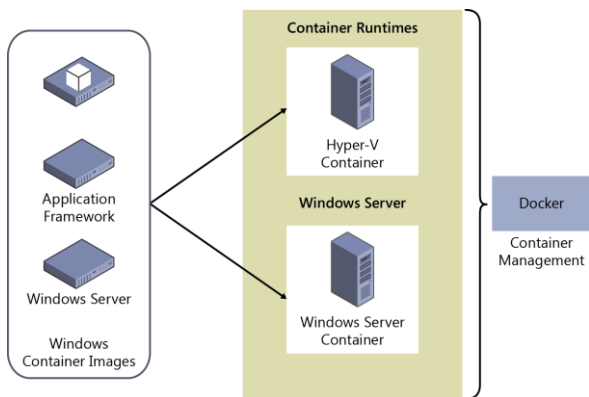

Figure 3-10: Containers can write once and deploy anywhere

Networking

One of the decisions you need to make is how do you want to allow your containers to communicate to the corporate network or outside work in general. Figure 3-11 presents a diagram showing how a container connects to the outside world.

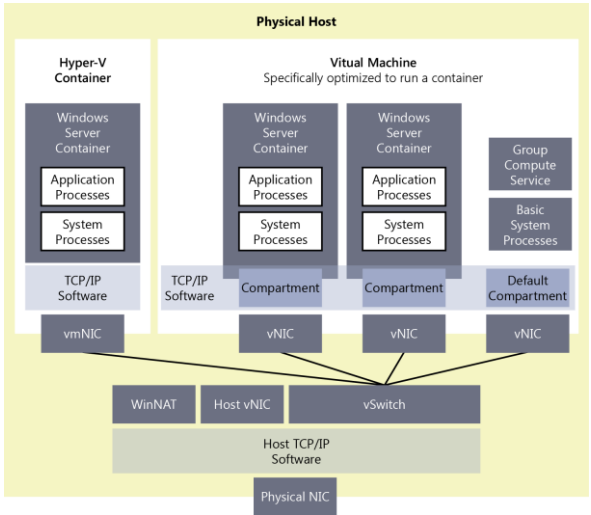

Figure 3-11: Containers network connectivity

As Figure 3-11 demonstrates, each container will connect via vNIC (Windows Server container) or a vmNIC (Hyper-V container) to the vSwitch configured in a host. Each vNIC is isolated from the next and is considered its own compartment. These vNICs connect to the vSwitch by ports (much like Hyper-V). The Physical Host vNIC is isolated from the containers. Network connectivity to Hyper-V containers is transparent to the utility VM through the vmNIC.

External connectivity is provided in a number of ways. Each one depends on the scenario you are using for containers. For example, if you want to offer a container environment for developers, Network Address Translation (NAT) is the best option for container network. It provides a private IP space (IPs issued via DHCP) that is isolated from the outside world. It restricts cross-container connectivity but does give you the ability to port forward into the container environment with which you are working. Any traffic arriving on the public NAT IP (the external NIC IP of the host) will be compared to a table managed via WinNAT and forwarded into the container.

If the developers or the business required a small deployment and required that the containers sit on the corporate IP space, you can use transparent networking for containers. This just uses (via DHCP or Static Assignment) your existing IP space to assign IPs to the containers you run. If you do not use DHCP, you are unable to set a Gateway IP address. In transparent networking, containers can communicate with one another and external services like SQL and so on.

Finally, if you are looking at cloud-scale deployments, we can use Layer 2 (L2) tunneling

or an L2 bridge. Both are essentially network virtualization for containers that make it possible for you to fully isolate traffic across a multinode deployment of containers in a datacenter.

In L2 bridge mode, the Virtual Filtering Platform (VFP) vSwitch extension in the container host will act as a bridge and perform Media Access Control (MAC) address rewrite as required. Layer 3 (L3) or Layer 4 (L4) remain unchanged.

You use L3 tunnel mode when you require a network policy in a cloud deployment scenario. The external vSwitch provides all the connectivity options for the container. All container traffic is forwarded through the physical host and the MAC address is rewritten before entering the network fabric.

By default, Docker will try to bind to NAT networking, if it does not find a NAT network to bind to, it will attempt to create one. Any containers created after this will attach to the NAT network for connectivity. You can override this default behavior by running the following, for example:

```
Docker -b "none"
```

The "none" represents the name of a network; -b represents bridge. In this case, we are not attaching to anything.

To create to a transparent network, you could use the following:

```
Docker network create -d transparent -gateway 192.168.0.254 "TransparentNET"
```

Multiple container networks

For cases in which you need to have multiple networks on a container host, the following rules apply

- Only one NAT network can be created per container host.
- Multiple networks that use an external vSwitch for connectivity (for example, transparent, L2 bridge, and L2 transparent) must each use its own network adapter.
- Different networks must use different vSwitches.

Firewalls

Every container host has a set of firewall rules turned on by default, the firewall rules are configured with a default set. If you want containers to be pingable (ICMP) or receive an IP Address from DHCP, you need to ensure that the container host has these rules turned on. To allow different traffic types into the containers you also will need to configure additional rules.

If you are using NAT and decide to turn on port forwarding for the containers, the firewall rules will be automatically created for you during configuration.

Troubleshooting

Docker no longer keeps a separate log file; it logs all events to the Application Log in Event Viewer.

You can filter based on source equal to Docker and retrieve all of its events or you can use Windows PowerShell to review the log, as well, by using the following code:

```
Get-EventLog -LogName Application -Source Docker
```

You could also start Docker in debug mode by using this:

```
Dockerd.exe -D
```

Or, use the docker configuration file (you can locate this file [or place it if it does not exist] at C:\ProgramData\docker\config\daemon.json) to start debug mode as follows:

```
{  
  "debug": true  
}
```

Installing containers

To use Windows Server Containers, you must first install the Containers feature. Further, if you would like to also use Hyper-V Containers, you will have to also install the Hyper-V feature.

You will then need to install and set up Docker, which does not come with Windows Server 2016.

More info Follow the URL for details on how to set up these feature and how to install and set up Docker, go to <https://aka.ms/windowscontainers> and read the Quick Start guides.

Rules for containers

For Windows, the container image you download *must* be an OS image that matches the container host in respect of build and patch level. Table 3-1 details the support of what base image will run on what type of container host.

Table 3-1: Supported container images on container hosts

		Container OS runtime	
		Server Core	Nano Server (AB1)
Container Host OS Deployment	Server with UI (LTSB)	Windows Server Containers and/or Hyper-V Containers	Windows Server Containers and/or Hyper-V Containers
	Server Core (LTSB)	Windows Server Containers and/or Hyper-V Containers	Windows Server Containers and/or Hyper-V Containers
	Nano Server (AB1)	Hyper-V Containers	Windows Server Containers or Hyper-V Container

Patching a container host will require you to patch the container image and commit to ensure normal operation.

Microsoft will provide an updated Windows Docker image on a monthly basis, which you can use to rebuild your container image.

If you are planning on using Hyper-V containers inside a guest VM, you must ensure the following:

- Nested Virtualization is turned on for the container host
- There is at least 4 GB of RAM on the host
- You're using Windows Server 2016 or Windows 10 for the host OS
- The container host guest VM needs at least two virtual processors

There are additional images in the Docker repository that also follow the same rules.

More info This book does not present a deep deployment guide for Windows Server containers. For more information, go to https://msdn.microsoft.com/virtualization/windowscontainers/quick_start/manage_docker.

Security and identity

Over the past several years, cybersecurity has been consistently rated as a top priority for IT. This is not surprising, given that top companies and government agencies are being publicly called out for being hacked and failing to protect their customers' and employees' personal information.

On the other hand, with readily available tools and a lack of adequate protections, attackers are able to infiltrate large organizations and remain undetected for long periods of time while conducting exfiltration of secrets or attacking internal resources.

In this chapter, we explore the layers of protection in Microsoft Windows Server 2016 that help address emerging threats and make it an active participant in your security defenses. First, we will describe the new shielded virtual machine solution that protects virtual machines (VMs) from attacks on the underlying fabric.

Then, we introduce you to the extensive threat-resistance components built in to the Windows Server 2016 operating system (OS) and the enhanced auditing events that can help security systems detect malicious activity.

Last, we will share with you an end-to-end plan for securing privileged access based on existing and new capabilities in Windows Server.

Shielded VMs

By John Saville

Today, in most virtual environments there are many types of administrators who have access to VM assets, such as storage. That includes virtualization administrators, storage administrators, network administrators, backup administrators, just to name just a few. Many organizations including hosting providers need a way to secure VMs—even from administrators—which is exactly what shielded VMs provides.

Keep in mind that this protection from administrators is needed for a number of reasons. Here are just a few:

- Phishing attacks
- Stolen administrator credentials
- Insider attacks

Shielded VMs provide protection for the data and state of the VM against inspection, theft, and tampering from administrator privileges. Shielded VMs work for Generation 2 VMs that provide the necessary secure startup, UEFI firmware, and virtual Trusted Platform Module (vTPM) 2.0 support required. Although the Microsoft Hyper-V hosts must be running Windows Server 2016, the guest OS in the VM can be Windows Server 2012 or above.

A new Host Guardian Service instance is deployed in the environment, which stores the keys required for an approved Hyper-V host that can prove its health to run shielded VMs.

A shielded VM provides the following benefits:

- BitLocker encrypted drives (utilizing its vTPM)

- A hardened VM worker process (VMWP) that encrypts live migration traffic in addition to its runtime state file, saved state, checkpoints, and even Hyper-V Replica files
- No console access in addition to blocking Windows PowerShell Direct, Guest File Copy Integration Components, and other services that provide possible paths from a user or process with administrative privileges to the VM

How is this security possible? First, it's important that the Hyper-V host has not been compromised before the required keys to access VM resources are released from the Host Guardian Service (HGS). This attestation can happen in one of two ways. The preferred way is by using the TPM 2.0 that is present in the Hyper-V host. Using the TPM, the boot path of the server is assured, which guarantees no malware or root kits are on the server that could compromise the security. The TPM secures communication to and from the HGS attestation service. For hosts that do not have a TPM 2.0, an alternate Active Directory–based attestation is possible; however, this merely checks whether the host is part of a configured Active Directory group. Therefore, it does not provide the same levels of assurance and protection from binary

meddling and thus host administrator privileges for a sophisticated attacker. However, the same shielded VM features are available.

After a host undergoes the attestation, it receives a health certificate from the attestation service on the HGS that authorizes the host to get keys released from the key protection service that also runs on the HGS. The keys are encrypted during transmission and can be decrypted only within a protected enclave that is new to Windows 10 and Windows Server 2016 (more on that later). These keys can then be used to decrypt the vTPM to make it possible for the VM to access its BitLocker-protected storage and start the VM. Therefore, only if a host is authorized and noncompromised will it be able to get the required key and turn on the VM's access to the encrypted storage (not the administrator, though, as the virtual hard drive (VHD) remains encrypted on the drive).

At this point, it might be self-defeating: If I am an administrator on the Hyper-V and the keys are released to the host to start the VM, I would be able to gain access to the memory of the host and get the keys, thus nullifying the very security that should protect VMs from administrative privileges. Fortunately, another new feature in Windows 10 and Windows Server 2016 prevents

this from happening. This feature is the protected enclave mentioned earlier, which is known as Virtual Secure Mode (VSM). A number of components use this service, including Credential Guard. VSM is a secure execution environment in which secrets and keys are maintained and critical security processes run as *Trustlets* (small trusted processes) in a secure virtualized partition.

This is not a Hyper-V VM; rather, think of it like a small virtual safe that is protected by virtualization based on technologies such as Second Level Address Translation (SLAT) to prevent people from trying to directly access memory, I/O Memory Management Unit (IOMMU) to protect against Direct Memory Access (DMA) attacks, and so on. The Windows operating system, even the kernel, has no access to VSM. Only safe processes (Trustlets) that are Microsoft signed are allowed to cross the “bridge” to access VSM. A vTPM Trustlet is used for the vTPM of each VM, separate from the rest of the VM process, which runs in a new type of protected VM worker process. This means that there is no way to access the memory used to store these keys, even with complete kernel access. If I'm running with a debugger attached, for example, that would be flagged as part of the attestation process, the health check would fail,

and the keys would not be released to the host. Remember I mentioned the keys from the key protection service are sent encrypted? It's the VSM that decrypts them, always keeping the decrypted key protected from the host OS.

When you put all of this together, you have the ability to create a secure VM environment that is protected from any level of administrator (when using TPM 2.0 in the host) and will close a security hole many environments cannot close today.

More info To read detailed guides that Microsoft has provided to implement this scenario in your environment, go to <https://gallery.technet.microsoft.com/Shielded-VMs-and-Guarded-44176db3/view/Discussions>.

Threat-resistant technologies

Windows Server 2016 includes integrated threat-resistance technologies that make it an active component in your overall security story. These technologies range from blocking external attackers trying to exploit vulnerabilities (Control Flow Guard) to resistance to attacks by malicious users and software that gained administrator

access to the server (Credential Guard and Device Guard). In this section, we explore some of these new features.

Control Flow Guard

In Windows Server 2016 and Windows 10, the OS is protected by Control Flow Guard. This highly optimized platform security feature makes it much more difficult to run arbitrary code through exploits such as *buffer overflows*.

In addition, when a developer compiles his code, the compiler will perform some security checks on the code and then identify the set of functions that are considered a source for an indirect call. These indirect calls might come from a code exploit whereby malformed data is sent into the function, causing it to behave abnormally. The indirect call in non–Control Flow Guard–aware code can cause a memory buffer overrun, which can corrupt other applications or lead to privileged execution. However, because the compiler has identified these sets of functions as potential vulnerabilities and marked them, the runtime will detect and provide additional logic that verifies whether an indirect call is actually valid. If the indirect call validation fails, the application will terminate, preventing

the application from causing further damage to the system.

Device Guard on Windows Server 2016

With thousands of new malicious files created every day, using traditional methods like antivirus solutions—signature-based detection to fight against malware—might not be sufficient for some environments. Device Guard on Windows Server 2016 changes from a mode in which apps are trusted unless blocked by an antivirus or other security solution, to a mode in which the operating system trusts only apps authorized by your enterprise.

What is Device Guard

Device Guard can protect software running in Kernel mode and User mode. Under Kernel mode protection, Device Guard ensures that the drivers are at the very least signed by a known signature (WHQL signed) or you can further restrict the drivers by placing them in a safe-programs list in the policy. Device Guard will block drivers from loading dynamic code and block any driver that is not on the safe-programs list. If there is a compromised driver that tries to

modify code in memory, it cannot be run on the machine. Device Guard also provides User mode protection (UMCI), meaning that you can create Code Integrity (CI) policies that define what's trusted and authorized to run on individual servers.

For details on Device Guard, here are some good references (note that this is not a complete list):

- [Introduction to Device Guard](#)
- [Requirements for deployment planning for Device Guard](#)
- [Code integrity policies](#)

Enhanced Kernel Mode protection using Hypervisor Code Integrity

The core functionality and protection of Device Guard begins at the hardware level. Devices that have processors equipped with SLAT technologies and virtualization extensions, such as Intel VT x and AMD V, will be able to take advantage of a Virtualization Based Security (VBS) environment that dramatically enhances

Windows security by isolating critical Windows services from the operating system itself.

Device Guard uses VBS to isolate its Hypervisor Code Integrity (HVCI) service, which makes it possible for Device Guard to help protect kernel mode processes and drivers from vulnerability exploits and zero-day attacks. HVCI uses the processor's functionality to force all software running in kernel mode to safely allocate memory. This means that after memory has been allocated, its state must be changed from writable to read-only or run-only. By forcing memory into these states, it helps to ensure that attacks are unable to inject malicious code into Kernel mode processes and drivers through techniques such as buffer overruns or heap spraying.

To deliver this level of security, Device Guard has the following hardware and software requirements:

- UEFI Secure Boot (optionally with a non-Microsoft UEFI CA removed from the UEFI database)
- Virtualization support turned on by default in the system firmware (BIOS):

- Virtualization extensions (for example, Intel VT-x and AMD RVI)
- SLAT (for example, Intel EPT and AMD RVI)
- IOMMU (for example, Intel VT-d, AMD-Vi)
- UEFI BIOS configured to prevent an unauthorized user from disabling Device Guard–dependent hardware security features (for example, Secure Boot)
- Kernel-mode drivers signed and compatible with hypervisor-enforced code integrity

You can deploy HVCI (aka Virtualization Based Security of Code Integrity) by using Group Policy. It is recommended to enable HVCI on all the servers running Windows Server 2016. For more details of Group Policy configuration, go to <https://technet.microsoft.com/itpro/windows/keep-secure/deploy-device-guard-enable-virtualization-based-security>.

Deploy configurable code integrity policy

Historically, most malware has been unsigned. Simply by deploying code integrity policies, organizations can get immediate protection against unsigned malware, which is estimated to

be responsible for the vast majority of current attacks. By using code integrity policies, an enterprise can also select exactly which binaries are allowed to run in both User mode and Kernel mode. When completely enforced, it will load only specific applications or software with specific signatures. This feature alone fundamentally changes security in an enterprise.

You can run configurable code integrity independent of HVCI, thus making it available to devices that don't meet the HVCI hardware requirements.

Configurable code integrity policy offers a wide range of options to allow administrators to define the level of control of what software to trust on a server, ranging from allowing software signed by reputable publishers (e.g., Microsoft) to a specific file match hash.

It is recommended that you always first deploy code integrity policies in audit mode, which makes it possible for you to review the binaries fail to load under the policy. You can then adjust the policy before changing the code integrity policy to enforcement mode.

In this document, we illustrate two common types of code integrity policies: one for general

server usage, and another one for locked down servers:

- **General server usage** Servers that run a variety of workloads, expected to have new software installed from time to time, flexible in that for which they are used.
- **Locked down servers** Servers that run a specific workload, critical in their reliability, such as Hyper-V host or domain controllers.

Create code Integrity policy for general server usage

To create the code integrity policy, you can begin by building a reference server on their standard hardware, and then install all of the software that their servers are known to run. Then, run the following cmdlet:

```
New-CIPolicy -Level Publisher -Fallback Hash -  
UserPEs -FilePath C:\CI\Publisher.xml
```

More info For details of the level parameter, go to <https://technet.microsoft.com/en-us/itpro/windows/keep-secure/deploy-code-integrity-policies-policy-rules-and-file-rules#code-integrity-file-rule-levels>.

This cmdlet creates the policy by scanning the files on the server, and extracts the publisher information from the files and adds it to the policy. The policy is created in auditing mode. Under audit mode, files that are not covered by the CI policy will be able to load; however, they will be logged in the Microsoft\Windows\CodeIntegrity event log channel. Administrators can audit the logs to detect any security attacks.

As part of normal operations, they will get software updates or perhaps add software from the same software providers. Because the "Publisher" remains the same on those updates and software, there is no need to update the code integrity policy.

You can deploy the same code integrity policy to servers in the same category and running the same hardware.

Create code integrity policy for lockdown server

It is a similar process to create the code integrity policy on this category of servers, but with different level of control on the software you trust. For this type of server, we recommend using FilePublisher, to ensure only whitelisted

files can be loaded on the server. To create the Code Integrity policy, run the following cmdlet:

```
New-CIPolicy -Level FilePublisher -Fallback Hash -  
UserPEs -FilePath C:\CI\FilePublisher.xml
```

This cmdlet creates the policy by scanning the files on the server and creates a safe-program list of the files by their name, version, and publisher info in the policy. Only the files are on the safe-program list with matching name, publisher, and version equal or greater is considered as trusted. In the case of software update, the update to the files covered by the policy will have a higher version number; therefore, you won't need to regenerate CI policy. If there are new files added to the server, you will need to scan the new files, and merge it to the existing CI policy.

The cmdlet creates the policy in Audit mode, you can validate the policy in the Audit mode first, ensuring that all the files you trust are covered by the CI policy. After you are comfortable with it, you can run the following cmdlet to change it to enforcement mode:

```
Set-RuleOptions -FilePath C:\CI\FilePublisher.xml -  
Option 3 -delete
```

Deploy code integrity policy

The xml file created by the New-CIPolicy can't be consumed by the system yet. To deploy the policy, it needs to be converted to binary format, and copied to the CodeIntegrity folder under system32.

Run the following cmdlet to convert the xml file:

```
ConvertFrom-CIPolicy C:\CI\FilePublisher.xml  
C:\CI\FilePublisher.bin
```

Deploy CI policy:

```
Copy-Item C:\CI\FilePublisher.bin  
C:\Windows\System32\CodeIntegrity\SiPolicy.p7b
```

Reboot the server to allow code integrity service to load the policy.

More info For some basic information on how to get started with Code Integrity policies as well as further information about creating an audit policy and deploying it via Group Policy, go to [https://technet.microsoft.com/library/mt463091\(v=vs.85\).aspx#code_integrity_policies](https://technet.microsoft.com/library/mt463091(v=vs.85).aspx#code_integrity_policies).

Credential Guard

Credential Guard isolates secrets by using virtualization-based technologies so that only privileged systems can access them. Credential Guard offers the following features:

- **Hardware security** This increases the security of derived domain credentials by taking advantage of platform security features, including Secure Boot and virtualization.
- **Virtualization-based security** Windows services that manage derived domain credentials and other secrets run in a protected environment that is isolated from the running OS.
- **Better protection against advanced persistent threats** Secures derived domain credentials by using the virtualization-based security. This blocks the credential theft attack techniques and tools used in many attacks. Malware running in the OS with administrative privileges cannot extract secrets that are protected by virtualization-based security.

- **Manageability** Manage by using Group Policy, WMI, from a command prompt, and Windows PowerShell.

Normally, secrets are stored in the memory of the Local Security Authority (LSA) process in Windows. With Credential Guard, the LSA talks to a new component called *isolated LSA*. This isolated LSA is virtualization-based and is not accessible by the rest of the OS. Figure 4-1 illustrates the isolation provided by the Virtualization-based security for the LSAIso process in respect the LSASS process.

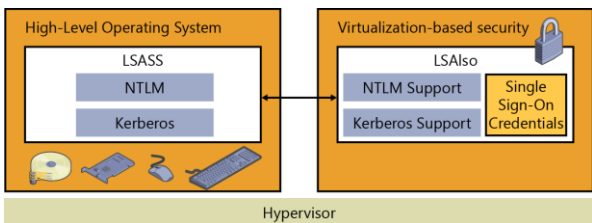

Figure 4-1: Virtualization-based LSA process

When Credential Guard is turned on, older variants of NTLM or Kerberos (i.e., NTLM v1, MS-CHAPv2, etc.) are no longer supported.

Because Credential Guard is virtualization-based, it requires some specific hardware support. The following table details some of those requirements:

Requirement	Description
Windows Server 2016 S	Credential Guard is available on all Windows Server 2016 SKUs except for Nano Server (because Nano Server only supports remote management).
UEFI firmware version 2.3.1 or higher and Secure Boot	To verify that the firmware is using UEFI version 2.3.1 or higher and Secure Boot, you can validate it against the System.Fundamentals.Firmware.CS.UEFIsecureBoot.ConnectedStandby Windows Hardware Compatibility Program requirement.
Virtualization extensions	<p>The following virtualization extensions are required to support virtualization-based security:</p> <ul style="list-style-type: none"> • Intel VT-x or AMD-V • Second Level Address Translation
x64 architecture	The features that virtualization-based security uses in the Windows

	hypervisor can run only on a 64-bit PC.
A VT-d or AMD-Vi IOMMU	An IOMMU enhances system resiliency against memory attacks.
TPM version 1.2 or 2.0	Note: If you don't have a TPM installed, Credential Guard will still be turned on, but the keys used to encrypt Credential Guard will not be protected by the TPM.
The firmware is updated for Secure MOR implementation	Credential Guard requires the secure MOR bit to help prevent certain memory attacks.
Physical PC or VM	Credential Guard is supported on both physical machines or virtual machines. For virtual machine, the Hypervisor needs to support nested virtualization.

The simplest way to get Credential Guard implemented for your organization is to turn it on via Group Policy and designate the machines in your enterprise for which you want to apply it.

From the Group Policy Management Console, create a new group policy or edit an existing one. Then, go to Computer Configuration > Administrative Templates > System > Device Guard.

Double-click Turn On Virtualization Based Security, and then, in the dialog box that opens (see Figure 4-2), select the Enabled option. In the Select Platform Security Level list box, choose Secure Boot or Secure Boot And DMA Protection. In the Credential Guard Configuration list box, select Enabled With UEFI lock, and then click OK. If you want to be able to turn off Credential Guard remotely, in the Credential Guard Configuration list box, choose Enabled Without Lock instead of Enabled With UEFI Lock.

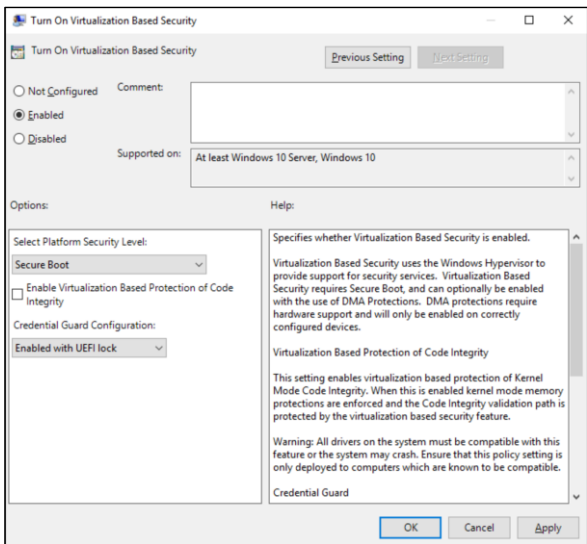

Figure 4-2: Group policy options for Credential Guard

More info For further information, go to [https://technet.microsoft.com/library/mt483740\(v=vs.85\).aspx](https://technet.microsoft.com/library/mt483740(v=vs.85).aspx).

Remote credential guard

Remote credential guard provides protection against your credentials being stolen when you are remotely connected to a system via a remote desktop session.

When a user attempts to remote desktop to a remote host, the Kerberos request is redirected back to the originating host for authentication. The credential simply does not exist on the remote host any more. If a remote host (i.e., an end user's computer or server) has malicious code running on it that can obtain credentials, remote credential guard will mitigate this because no credentials will be passed into the remote host.

There are some requirements for remote credential guard to operate:

- The user must be joined to the same Active Directory domain or a remote desktop server must be joined to a domain with a trust relationship to the client device's domain.

- They must use Kerberos authentication.

- They must be running at least Windows 10, version 1607 or Windows Server 2016.

- The Remote Desktop classic Windows app is required. The Remote Desktop Universal Windows Platform app doesn't support Remote Credential Guard.

To turn on remote credential guard, you can configure this via a group policy and widely deploy this across your estate.

To configure this via group policy, open the Group Policy Management Console, and then go to Computer Configuration → Administrative Templates → System → Credentials Delegation. Next, double-click Restrict Delegation To Remote Servers, and then select Require Remote Credential Guard. Finally, click OK and run `gpudpate /force` to push the group policy out. (You also can turn on remote credential guard via registry key—see the following “More info” link.)

More info To learn more about deploying remote credential guard, go to <https://technet.microsoft.com/itpro/windows/keep-secure/remote-credential-guard>.

Windows Defender

Windows Defender is included (and running) by default when you install Windows Server 2016.

If your organization has a company standard for malware technology, you can uninstall it by using Windows PowerShell, as well:

```
Uninstall-WindowsFeature -Name Windows-Server-Antimalware
```

Windows Defender receives updates via Windows Update. If your organization manages

Windows Update via an update deployment tool, you need to ensure that you are downloading the updates to keep Windows Defender up to date with its definitions.

You also can configure Windows Defender via Group Policy for central control and administration.

Threat detection technologies

No matter how much you try to secure an environment, you still need to perform audits to validate whether those measures are effective. Windows Server 2016 introduces two new audit subcategories to give you greater insight into the events:

- **Audit Group Membership** This is part of the Logon/Logoff event category. The events in this subcategory are generated when group memberships are enumerated or queried on the PC where the sign-in session was created.
- **Audit PNP Activity** Found in the Detailed Tracking category, you can use the Audit PNP Activity subcategory to audit when plug-and-play detects an external device.

Only Success audits are recorded for this category.

Additional changes have been made in Windows Server 2016 that expose more information to help you identify and address threats quickly. The following table provides more information:

Area	Improvements
Kernel Default Audit Policy	In previous releases, the kernel depended on the LSA to retrieve information in some of its events. In Server 2016, the process creation events audit policy is automatically turned on until an actual audit policy is received from the LSA. This results in better auditing of services that might start before the LSA starts
Default process Security ACL (SACL) to LSASS.exe	A default process, SACL was added to LSASS.exe to log processes attempting to access LSASS.exe. The SACL is L"S:(AU;SAFA;0x0010;;;WD)". You can turn this on under Advanced Audit Policy Configuration Object Access Audit Kernel Object.

<p>New fields in the sign-in event</p>	<p>The sign-in event ID 4624 has been updated to include more verbose information to make them easier to analyze. The following fields have been added to event 4624:</p> <ul style="list-style-type: none">• MachineLogon String: yes or no <p>If the account that signed in to the PC is a computer account, this field will be yes; otherwise, the field is no.</p> <ul style="list-style-type: none">• ElevatedToken String: yes or no <p>If the account that signed in to the PC is an administrative sign-in, this field will be yes; otherwise, the field is no. Additionally, if this is part of a split token, the linked login ID (LSAP_LOGON_SESSION) will also be shown.</p> <ul style="list-style-type: none">• TargetOutboundUserName String and TargetOutboundUserDomain String
--	--

	<p>The user name and domain of the identity that was created by the LogonUser method for outbound traffic.</p> <ul style="list-style-type: none">• VirtualAccount String: yes or no <p>If the account that signed in to the PC is a virtual account, this field will be yes; otherwise, the field is no.</p> <ul style="list-style-type: none">• GroupMembership String <p>A list of all of the groups in the user's token.</p> <ul style="list-style-type: none">• RestrictedAdminMode String: yes or no <p>If the user signs in to the PC in restricted admin mode with Remote Desktop, this field will be yes.</p>
--	--

New fields in the process creation event

The sign-in event ID 4688 has been updated to include more verbose information to make it easier to analyze. The following fields have been added to event 4688:

- **TargetUserSid** String
The SID of the target principal.
- **TargetUserName** String
The account name of the target user.
- **TargetDomainName** String
The domain of the target user.
- **TargetLogonId** String
The logon ID of the target user.
- **ParentProcessName** String
The name of the creator process.
- **ParentProcessId** String

	<p>A pointer to the actual parent process if it's different from the creator process.</p>
<p>Security Account Manager (SAM) events</p>	<p>New SAM events were added to cover SAM APIs that perform read/query operations. In previous versions of Windows, only write operations were audited. The new events are event ID 4798 and event ID 4799. The following APIs are now audited:</p> <ul style="list-style-type: none"> SamrEnumerateGroupsInDomain SamrEnumerateUsersInDomain SamrEnumerateAliasesInDomain SamrGetAliasMembership SamrLookupNamesInDomain SamrLookupIdsInDomain SamrQueryInformationUser SamrQueryInformationGroup SamrQueryInformationUserAlias SamrGetMembersInGroup SamrGetMembersInAlias

	SamrGetUserDomainPasswordInformation
Boot Configuration Database (BCD) events	<p>Event ID 4826 has been added to track the following changes to the BCD:</p> <ul style="list-style-type: none"> DEP/NEX settings Test signing PCAT SB simulation Debug Boot debug Integrity Services Disable Winload debugging menu
PNP Events	<p>Event ID 6416 has been added to track when an external device is detected through plug-and-play. One important scenario is if an external device that contains malware is inserted into a high-value machine that doesn't expect this type of action, such as a domain controller.</p>

Securing privileged access

In this section, we are going to explore a few concepts regarding securing privileged access. First we are going to dive into the concepts of Just-in-Time and Just Enough Administration. Then, we are going to explain how you combine all of the tools and technologies we have discussed in this chapter into an implementation strategy for your organization.

Just-in-Time and Just Enough Administration

Just-in-Time (JIT) administration is a fairly basic concept: the principal is that we evolve to a state in which there are no full-time administrators, or, more specifically, we have no accounts that have full-time administrator privileges. Rather, through a simple process, the privileges required are requested just before they are actually needed, then approved, and then granted to the account for a specific time period. This ensures that the task can be carried out successfully with the correct amount of privileges for the allotted time. JIT works in conjunction with Just Enough Administration (JEA) to secure the correct

privileges. In Windows Server 2016, these technologies are combined to provide Privileged Access Management (PAM).

More info For more information about PAM, go to <https://technet.microsoft.com/library/dn903243.aspx>.

Now, let's take a quick look at JEA. This is part of the Windows Management Framework 5.0 package and has been supported since Windows Server 2008 R2. Using JEA, you can assign specific privileges (just enough of them) to a user account that are needed to perform a given required function. This means that you don't need to assign a user to an administrator account and then remember to remove that person later. JEA gives us the role-based access control (RBAC) that modern enterprises require to achieve more secure environments.

To implement JEA on a system, you first need a Windows PowerShell Session Configuration file. Use the `New-PSSessionConfigurationFile` cmdlet to create the `.pssc` file you need to control access by running the following syntax:

```
New-PSSessionConfigurationFile -Path  
"$env:Programdata\<<JEAConfigDirectory>\<filename>.ps  
sc"
```

The following is a sample of the default configuration file this command generates:

```
@{
# Version number of the schema used "for this
document
SchemaVersion = '2.0.0.0'
# ID used to uniquely identify this document
GUID = '1da190ce-fc94-4f8b-98e0-7d70fd9154b1'
# Author of this document
Author = 'john'
# Description of the functionality provided by these
settings
# Description = ''

# Session type defaults to apply for this session
configuration. Can be 'RestrictedRemoteServer'
(recommended), 'Empty', or 'Default'
SessionType = 'Default'
# Directory to place session transcripts for this
session configuration
# TranscriptDirectory = 'C:\Transcripts\'
# Whether to run this session configuration as the
machine's (virtual) administrator account
# RunAsVirtualAccount = $true
# Groups associated with machine's (virtual)
administrator account
# RunAsVirtualAccountGroups = 'Remote Desktop
Users', 'Remote Management Users'
# Scripts to run when applied to a session
# ScriptsToProcess =
'C:\ConfigData\InitScript1.ps1',
'C:\ConfigData\InitScript2.ps1'
# User roles (security groups), and the role
capabilities that should be applied to them when
applied to a session
# RoleDefinitions = @{ 'CONTOSO\SqlAdmins' = @{
RoleCapabilities = 'SqlAdministration' };
'CONTOSO\ServerMonitors' = @{ VisibleCmdlets = 'Get-
Process' } }
}
```

The core areas of interest to change are the `SessionType`, which is set to `Default`. For JEA to work, you need to configure this as `RestrictedRemoteServer`. Next, you need to uncomment `# RunAsVirtualAccount = $True`, which ensures that the session will have “virtual” administrator privileges. Finally, you need to modify the `RoleDefinitions` section and uncomment it to reflect your environment.

After you generate and set up the configuration file, you need to register it by using the `Register-PSSessionConfiguration` cmdlet.

```
Register-PSSessionConfiguration -Name <Name> -Path  
"$env:Programdata\<JEAConfigDirectory>\<filename>.ps  
sc"
```

You can test this by connecting to the machine as you would a normal Windows PowerShell remote session.

```
Enter-PSSession -ComputerName <ComputerName> -  
ConfigurationName <JEAConfigName> -Credential $cred
```

You can create another file called a Role Capability file with the extension `.psrc`. You can use this file to define what commands and applications are visible to the specific roles you define. You use the `New-PSRoleCapabilityFile` cmdlet to create a blank template.

This file contains sections in which you can define which modules to import and which functions and cmdlets are exposed.

```
# ModulesToImport = 'MyCustomModule',
@{ ModuleName = 'MyCustomModule2'; ModuleVersion =
'1.0.0.0';
GUID = '4d30d5f0-cb16-4898-812d-f20a6c596bdf'
}
# VisibleFunctions = 'Invoke-Function1',
@{ Name = 'Invoke-Function2';
Parameters = @{ Name = 'Parameter1';
ValidateSet = 'Item1', 'Item2' },
@{ Name = 'Parameter2'; ValidatePattern = 'L*' } }
# VisibleCmdlets = 'Invoke-Cmdlet1',
@{ Name = 'Invoke-Cmdlet2'; Parameters = @{ Name =
'Parameter1'; ValidateSet = 'Item1', 'Item2' },
@{ Name = 'Parameter2'; ValidatePattern = 'L*' } }
```

More info JEA is a detailed subject, and we can provide only the basics here. For further guidance and to see all of the configuration options, go to <http://aka.ms/JEA>.

A strategy for securing privileged access

It has to be said that no matter how secure you can make an operating system or service, it is only as secure as the weakest password. For example, suppose that you have the most sensitive data on earth and you encrypt it by using the most sophisticated technology, but

then you use a password like “Password01”; this utterly defeats the purpose of putting in place a battery of secure technologies.

Let’s look at another scenario. Walk around your office and count how many people have written their passwords on notes and stuck them on their keyboards or monitors. Then, observe how many people have pictures of their family or pets on their desk. When those people need to think of a password, what is the likelihood that it might be something personal based on the pictures?

Now, let’s consider a final scenario: the social engineering attack. With this particular form of attack—which is a leading cause of security breaks—the attacker calls someone, out of the blue, and pretends to be from IT, saying he needs to verify some account information. If the attacker is good at his job, the chances are high that the hapless victim will readily provide the information.

With those scenarios in mind, the attacker will gain access to something and potentially use that access to perform an escalated attack. But, what if the account were a privileged one in the first place.

Securing privileged access is not a single technology; it is a set of practices that an organization can implement to become more secure. Although focused primarily on privileged access, it highlights the need for any organization to implement and test all policies related to security and conduct the necessary readiness to make people aware of potential areas of exposure.

No network to which users have access will ever be 100 percent secure, but to begin down the path of securing privileged access to systems and networks, you must be diligent with regard to the following basics:

- **Updates** Deploy updates to domain controllers within seven days of release.
- **Remove users as local administrators** Monitor and remove users from local administrators if they don't need this access. Use Active Directory to control membership centrally, if required.
- **Baseline security policies** Deploy policies that will maintain a standard configuration for the organization. Exceptions will exist, of course, based on applications and certain requirements, but these should be

challenged on a repeated basis to ensure that the system is as compliant as possible.

- **Antimalware programs** Maintain regular updating and regular scans of the environment. Clean and remove threats as quickly as possible.
- **Log and analysis** Capture security information, perform regular reviews, and identify anomalies within the log set. Perform follow-up action on each detected item to ensure that it is an identified source and safe “risk.”
- **Software inventory and deployment** Controlling the software installed in an environment is paramount to ensure that end users don’t install malware into the environment. In the same manner, it is important to know what software is out there and maintain an inventory so that you are aware if the state of a system has changed.

With these basics covered, we can move into more details about the strategy that underpins securing privileged access. Be aware that you will not achieve this strategy overnight, and this should be built as a progressive implementation

so that the organization's practices can change and adapt to these new principles.

As with most strategies, you need to establish short-, medium-, and long-term goals. The following table describes the goals and the time frames you should use as well as the areas of focus for each goal.

Goal	Time frame	Description
Short term	2- to 4-week plan	Quick mitigation of the most frequently used attacks
Medium term	1- to 3-month plan	Build visibility and control of administrative activity
Long term	6 months and beyond	Build a proactive security posture

Short-term plan

For the short-term goal, it is critical that you mitigate the most frequently used attacks in any organization to provide a secure base.

One of the first things you need to do is to establish *separation of duties*. This means that if

you need to perform a privileged-access task, you should have an appropriate privileged-access account to carry it out. You should never grant your standard user account privileged access in a network to perform tasks. This account should always be considered a user. The privileged-access account you create for tasks can be audited and tracked in more detail. Because you maintain a different set of credentials for this account with stricter requirements, you will be able to mitigate an attack if your user account is compromised.

Securing the local administrator account was previously done during deployment and was rarely changed after it was set. The password was usually kept the same throughout the entire estate of workstations, which led to a huge problem if the password was compromised. However, if you don't use the same password throughout the estate, you might have a more complicated problem trying to remember the unique password for each of the workstations. To help you manage the local administrator password for both workstations and servers, Microsoft provides a tool called Local Administrator Password Solution (LAPS).

LAPS creates a unique password for each server and workstation in an environment and stores

them in Active Directory as a confidential attribute in the computer object. They have an appropriate access control list applied to them so that only the appropriate accounts can access them and retrieve them as necessary. For more information on LAPS, go to <http://aka.ms/LAPS>.

The final key part of the short-term goals should be focused around creating Privileged-Access Workstations (PAWs). PAWs are hardened workstations implemented specifically to act as a controlled point of administration to more secure systems. PAWs would be restricted from accessing the Internet or unsecure resources, ensuring that their attack surface is held to an absolute minimum. Only a restricted set of authorized users would also be able to sign in to the PAWs, which in turn would reduce the ability to attack secure part of the networks. For more information on PAWs, go to <http://aka.ms/CyberPAW>.

Figure 4-3 illustrates the steps that you can take as part of your short-term plan.

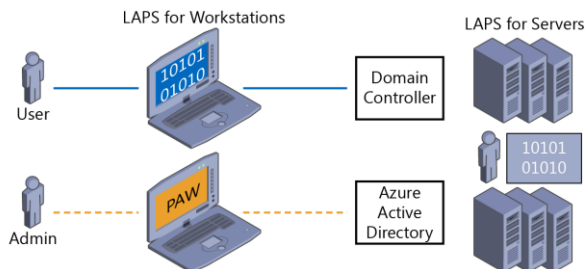

Figure 4-3: Short-term goal plan

The figure shows four separate areas:

1. Create a separate administrator account for administrative tasks as shown with the Admin User.
2. Deploy PAWs for Active Directory administrators. For more information, go to <http://aka.ms/cyberPAW>, where this step is shown as Phase 1.
3. Create unique LAPS for workstations. For more information, go to <http://aka.ms/LAPS>.
4. Create unique LAPS for servers. For more information, go to <http://aka.ms/LAPS>.

Medium-term plan

The first thing you need to do for your medium-term plan is to expand the deployment of PAWs so that you can bring more systems into scope, which you can manage only from these workstations. Following on from that, you should begin to focus on implementing time-bound privileges; that is, a user can request privileges that will expire after a predefined period of time. This means that there does not need to be actual administrators, as such, because the users can request the access they need, be approved, and perform the necessary tasks. This concept is based on Microsoft Identity Manager and functions provided by JEA.

You also should implement multifactor authentication for privileged access to further mitigate attacks on the systems. You can do this by using token-based security or call-back or smart cards. Next, you can begin to implement JEA. JEA is simple in principle because it specifies that you grant the very minimal amount of privileges to an account that are needed to perform the given function. We will talk about JEA in more detail later in this chapter.

Further securing domain controllers is the next step, and you will finish by implementing threat

detection via Advanced Threat Analytics (ATA). ATA provides the ability to detect abnormal behavior in your systems and make you aware of them quickly. It does this by profiling your user's behavior and establishing what that user's normal patterns are. If the user does something outside this normal pattern, ATA will alert you. ATA is far more advanced than this simple explanation implies. To learn more about it, go to <http://aka.ms/ata>.

Figure 4-4 presents an illustrated overview of the medium-term plan.

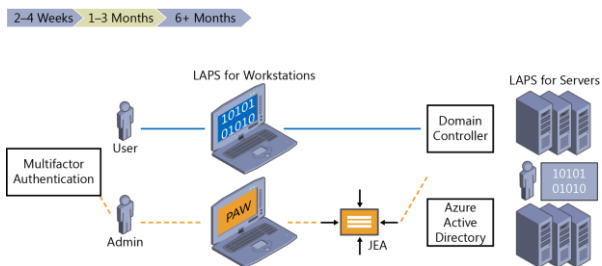

Figure 4-4: Medium-term goal plan

The figure shows six separate areas:

1. Extend PAWs to all administrators and provide additional hardening such as Credential Guard and RDP Restricted Admin. For more information, go to

<http://aka.ms/CyberPAW>, where this is shown in Phases 2 and 3.

2. Establish time-bound privileges (no permanent administrators). For more information, go to <http://aka.ms/AzurePIM>.
3. Create multifactor elevation. For more information, go to <http://aka.ms/PAM>.
4. Provide JEA for domain controller maintenance. For more information, go to <http://aka.ms/JEA>.
5. Lower the attack surface of domains and domain controllers. For more information, go to <http://aka.ms/HardenAD>.
6. Implement attack detection for your servers and domain controllers. For more information, go to <http://aka.ms/ata>.

Long-term plan

The long-term goals (see Figure 4-5) detail the final parts to date in an ever-evolving strategy. Securing your environment never stops. Therefore, this strategy will need to be reviewed and adapted over time, but it will provide you with a basis to begin and grow.

As with software development, you should apply a lifecycle with regard to how you control access to resources. Your approach should be based on the latest principles and JEA. Following on from this, all administrators should be issued strong authentication mechanisms such as SmartCard or Passport Authentication.

To really enhance protection, you can implement a secure forest that is isolated from a traditional user forest. Here, you can store the most secure systems in the environment and be fully isolated from the production network. The next section is to implement code integrity, which will ensure that only authorized code can be run on the systems.

Finally, you can use a new feature in Hyper-V Server 2016 called shielded virtual machines. This uses a Generation 2 VM to encrypt a VM. In this case, you can begin by focusing on domain controllers so that an attacker can't inspect a VM and copy it from the drives or do a host attack to gain access to the VM. Shielded VMs are described further later in this chapter.

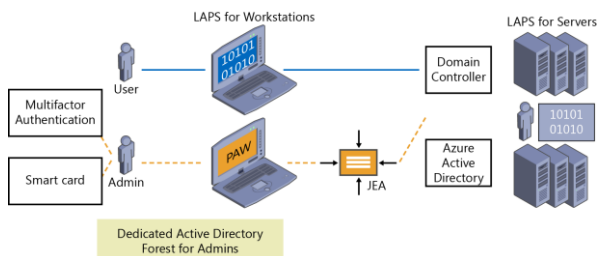

Figure 4-5: Long-term goal plan

The figure identifies the following areas:

1. Modernize roles and the delegation model
2. Implement smart card or passport authentication for all administrators (<http://aka.ms/passport>)
3. Create a specific administrator forest for Active Directory administrators (<http://aka.ms/ESAE>)
4. Implement a code-integrity policy for domain controllers in Windows Server 2016
5. Implement shielded VMs for domain controllers in Windows Server 2016 and Hyper-V Fabric (<http://aka.ms/shieldedvms>)

Identity

Now let's take a look at some other elements that go hand-in-hand with security: the improvements within the identity stack in Windows Server 2016.

Active Directory Domain Services

Microsoft focused on three main areas for improvement in this release:

- Privileged access management
- Azure Active Directory Join
- Microsoft Passport

Let's dive into each of these topics a bit deeper to explain the exciting things being introduced into the platform.

Privileged Access Management

The world of cyber threats becomes more complicated every day, and because it is such an invisible threat in most cases, we need to apply security in layers on different levels to mitigate every feasible possibility. PAM was introduced to help mitigate common credential theft threats like pass-the-hash, spear phishing, and so on.

PAM requires that you deploy Microsoft Identify Manager (MIM).

More info For an introduction and deployment information about MIM, go to <https://aka.ms/vaz62m>.

Most Active Directory environments would like to believe that they are completely clean of malicious activity, but the truth is that we can't be 100 percent sure. For this reason, one of the first things PAM implements is a new bastion forest where it can guarantee that it is free from malicious activity. A special type of trust is established called a PAM Trust. This bastion forest is provisioned by MIM during the initial deployment. Figure 4-6 shows the basic concept of the new forest and the PAM trust established.

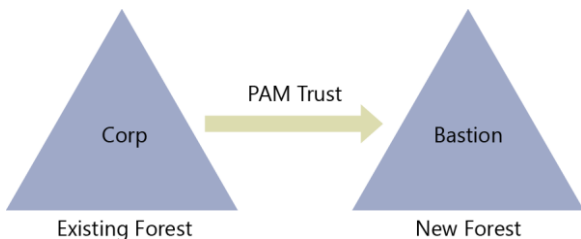

Figure 4-6: The new bastion forest and PAM Trust in PAM

PAM provides the ability to isolate the use of privileged accounts by storing them in this bastion forest and making it more difficult for attackers to gain privileged access. MIM is used to provide methods for users to be able to securely request and obtain administrative privileges when they need them. After being “approved” by MIM’s workflows, a shadow security principle is provisioned in the bastion forest. These shadow security principals are “linked” via a reference that is stored in an Active Directory attribute that essentially points to a SID of a privileged group in the original forest.

Users can request the privileged access by the following methods:

- The MIM Services Web API
- A REST Endpoint
- Windows PowerShell (using the New-PAMRequest cmdlet)

These simple methods can be integrated into other tools like automation runbooks and ticketing systems to provide further control on the overall process.

Earlier in this chapter, we mentioned the concepts and technology of JIT and JEA, PAM is a way of implementing this for your

environment. Like JIT and JEA, PAM provides time-bound privileges to the request account and, of course, link it to the privileged group that has the necessary permissions to perform the task.

You also can adjust the Kerberos ticket lifetime to ensure it has the lowest possible Time-to-Live (TTL) value. This way, if you sign in and receive a Kerberos ticket, its lifetime will be bound to the time remaining from the total amount of time PAM has granted you access to the privileged group.

PAM also comes with a variety of new monitoring features to provide greater insight with respect to who requested access, what type of access was actually granted, and, more important, what activities that person performed during the privileged-access assignment.

You can view this information MIM or in the Event Viewer, or if you already have System Center Operations Manager 2012 provisioned and use the Audit Collection Services, you can create visualizations of the information. Other third-party tools and Operations Management Suite (OMS) will be able to visualize the information in the future, as well.

Azure Active Directory Join

When enterprises begin to adopt the cloud and the work force becomes mobile, managing an estate that rarely touches the corporate network can become troublesome. There are a variety of other challenges that occur; for example, how do you give access to organizational resources on a noncorporate device. Whatever the challenge Azure Active Directory (Azure AD) Domain Join is another feature in Windows Server 2016 that will enhance the overall experience for identify and offer new capabilities for both corporate and personal devices alike. Figure 4-7 demonstrates the possibilities for Azure AD Join.

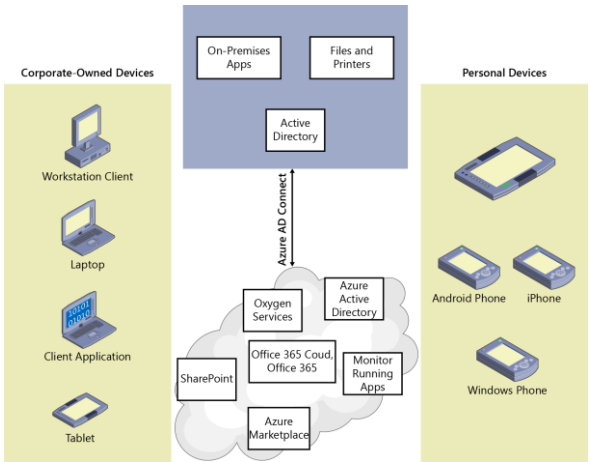

Figure 4-7: Azure AD Join

Here are some of the benefits that come with Azure AD today:

- Availability of modern settings

On any device connected to a Windows domain or joined to an Azure AD Tenant, you now can access with your corporate credentials settings such as the following:

Roaming or personalization, accessibility settings, and credentials

Backup and restore

Access to the Windows Store with your corporate credentials

Live tiles and notifications

- Access organizational resources

On any device that traditionally can't be domain joined. Now, you can grant access to corporate resources.

- Single sign-on (SSO)

Provide SSO capabilities to Microsoft Office 365, internal resources, Software as a Service (SaaS) solutions, and so on.

- Bring Your Own Device (BYOD) equipment
On personal devices where you need to access corporate resources you can now specify a work account from which you can access those resources and be influenced by new technologies like Conditional Access.
- MDM integration
Provides the ability for the BYOD scenario to become corporate-controlled resources via an autoenroll solution to your Mobile Device Management (MDM) solution like Microsoft Intune.
- Kiosk Mode for multiple users
You can configure a device in kiosk mode so that many users can interact with a single modern app; for example, a sign in application at the reception area of an enterprise.
- Developer experience
Lets your developers build applications that can cater to business and personal uses on a single stack
- Imaging

Give further control to the end users to accept the corporate image or allow corporate policies to be configured during the first-run experience.

Although these are all great features, why should you suddenly begin to adopt Azure AD Join? Actually, there can be a variety of reasons, depending on what type of organization you are in. For example, if yours is a startup organization with a large mobile foot print, providing users with the ability to use their own laptops or personal machines that can connect to Azure AD Join would save time and effort for the roll-out of a corporate policy. This would even stand true for more mature organizations in relation to new markets that they want to penetrate and the difficulty they might have in sending machines from corporate to the remote offices. Another possibility would be around educational institutions and cloud email solutions such as those offered as a part of Office 365. These institutions can manage all users in Azure AD and provide access to cloud email and control access to other resources like Microsoft SharePoint Online.

Finally, it is important to highlight not only the variations between the different methods and how users will be affected, but also what they

will be able to do. Table 4-1 lists some of the key differences.

Table 4-1: Variations across different “join” methods

Corporate device (joined to on-premises domain)	Corporate device (joined to the cloud)	Personal device
---	--	-----------------

<p>Users can sign in to Windows with work credentials (as they do today).</p>	<p>Users can sign in to Windows with work credentials that are managed in Azure AD. This is relevant for corporate devices in three cases:</p> <ul style="list-style-type: none">• The organization doesn't have Active Directory on-premises (for example, a small business).• The organization doesn't create all user accounts in Active Directory (for example, accounts for students, consultants, or seasonal workers are not created in Active Directory).• The organization has corporate devices that can't be joined to an (on-premises) domain, like phones or tablets running a Mobile SKU (for example, a secondary device taken to a factory/retail floor). Azure AD Join supports	<p>Users sign in to Windows with their personal Microsoft account credentials (no change).</p>
---	--	--

	joining of corporate devices for both managed and federated organizations.	
Users have access to roaming settings and the enterprise Windows Store. These services work with work accounts and don't require a personal Microsoft account. This requires organizations to connect their on-premises Active Directory to Azure AD.	<ul style="list-style-type: none"> • Users can do self-service setup. They can go through the first-run experience (FRX) via their work account as an alternative to having IT provision the devices, although both methods are supported. 	Users can easily add a work account that's managed in Active Directory or Azure AD.
Users have SSO ability from the desktop to work apps, websites, and resources—including both on-premises resources and cloud apps that use Azure AD for authentication.	Devices are automatically registered in the enterprise directory (Azure AD) and automatically enrolled in mobile device management. (Azure AD Premium feature).	Users have SSO ability across apps and to websites/resources with this work account.

<p>Users can add their personal Microsoft accounts to access their personal pictures and files without affecting enterprise data. (Roaming settings continue to work with their work accounts.) The Microsoft account makes SSO possible and no longer drives the roaming of settings.</p>	<p>Users can do a self-service password reset (SSPR) on winlogon, meaning they can reset a forgotten password. (Azure AD Premium feature).</p>	<p>Users have access to the enterprise Windows Store so that they can acquire and use line-of-business apps on their personal devices.</p>
--	--	--

Microsoft Passport

Authentication methods are moving at a faster pace than ever before. Think about it for a moment: you sign in to your laptop and then open your browser to go to your favorite websites where you again sign in. In these instances, you are not always using your corporate credentials. If you hear of a new service and want to access it, the chances are that you will be prompted to sign up and use credentials from, for example, your public

Microsoft account, Facebook, Google, and so on. The traditional paradigm of using a dedicated identity authentication provider that you build as an application developer is moving on and we are now using more “well-known” services like those just mentioned.

Microsoft Passport is a new key-based authentication method that goes beyond passwords to mitigate traditional authentication attacks. A user enrolls for Microsoft Passport but must ensure that the authentication provider she uses supports Fast Identity Online (FIDO) authentication; thus, through a two-step process, the user sets up Microsoft Passport on her device and sets a gesture or PIN. This can then be used to authenticate the user via Microsoft Passport

During the setup, a certificate of asymmetric key-pair is stored on the device. The private key is stored within the TPM chip on the device. The private key never leaves the device during the authentication process. The public key is registered in Azure Active Directory and Windows Server Active Directory. The user account has a mapping between the public and private key, which helps to validate the user. Additional controls are implemented via One Time Passwords, Phonefactor, and so on.

More info For further information on deploying Microsoft Passport check the following link <https://aka.ms/bh1m24>.

Active Directory Federation Services

As we move forward in a cloud-focused world, being able to control your identity is becoming more important. We need to think about how we can use our corporate identity to access applications that we don't technically own anymore. We also need to think about how we provide access to applications we own to other organizations in a secure and controlled manner without having a cumbersome user-management process.

Active Directory Federation Services (AD FS) provides this ability so that you can connect to applications that are on-premises or in the cloud (Platform as a Service [PaaS] or SaaS) with your corporate identity.

AD FS has been around for quite a while (since AD FS 2.0), and with Windows Server 2016, there are further enhancements to the technology to ensure that it meets the next level of demands

from organizations in the cloud world. Here are some of the key improvement areas for AD FS:

- Multifactor authentication

Windows Server 2016 contains a built-in Azure MFA adapter to simplify the process of using Azure MFA as the primary provider for authentication. There is no longer a need to deploy an on-premises MFA server.

- Device registration for hybrid conditional access

You now can configure AD FS to recognize the device status. This means that you can manage the device and apply policies as necessary. This will ensure that the device stays compliant to corporate policy and reduce potential risks to corporate resources.

More info For further information, go to <https://aka.ms/i4jy7h>.

- Windows 10 and Microsoft Passport integration

Microsoft Passport and AD FS have been designed to integrate to provide a further

seamless authentication experience for Windows 10 users.

- Lightweight Directory Access Protocol (LDAP) integration to secure non-AD directories

Many organizations don't rely on Active Directory for their identities. When this is the case, AD FS will integrate into LDAP v3-compliant directories. This will allow further integration into the cloud using those identity providers and the same enterprise experience when using Active Directory.

More info For further information, go to <https://aka.ms/qqupdh>.

- Auditing improvements

Auditing in AD FS has been quite complicated in the past, with lots of verbose information that is difficult to track. In Windows Server 2016, Microsoft has streamlined these improvements to provide a more consistent auditing experience and provide easier methods to trace through the logs.

More info For further information, go to <https://aka.ms/ftbvm1>.

- SAML 2.0 improvements

SAML support has been improved in Windows Server 2016 with the inclusion of importing trusts based on metadata that contains multiple entities. With this support, you can configure AD FS to participate in confederations such as InCommon Federations as well as other implementations conforming to eGov 2.0.

More info For further information, go to <https://aka.ms/d1xw4q>.

- Customized sign-in experience

In Windows Server 2016 you can customize messages, images, logos, and themes on a per application basis, making it possible for multiorganizations to have one deployment rather than multiple to suit the individual units. You can extend these customizations on a per-relying party basis, as well.

More info For further information, go to <https://aka.ms/f6rxu8>.

- Simplified password management for federated Office 365 users

AD FS can now send password expiry claims to relying party trusts. The application users will be notified of their expiring passwords and then have the ability to take action and change their passwords.

More info For further information, go to <https://aka.ms/i8jq9x>.

- Configure access control policies without knowing the claim rules language

In Windows Server 2016, there are new access control policy templates which ease the configuration of claims rules. These templates bring a simple UI-driven process to quickly and securely create claims rules for the organization.

More info For further information, go to <https://aka.ms/rf833l>.

- Migration from previous versions of AD FS

The upgrade process for AD FS has been greatly simplified in Windows Server 2016. Now, all you need to do is install a Windows

Server 2016 AD FS instance into an existing farm, verify the functionality, and then remove the previous versions. AD FS in Windows Server 2016 can “act” like a previous version of AD FS.

More info For further information, go to <https://aka.ms/qo74pk>.



Tell us what you think!

Is this book useful?
Does it meet your expectations?
Is there room for improvement?

Let us know at
<http://aka.ms/tellpress>

Your feedback goes directly to the staff at Microsoft Press, and we read every one of your responses. Thanks in advance!

Systems management

By John McCabe and Ritesh Modi

This chapter explores some of the new elements for Windows Server 2016 related to systems management. We begin the discussion with Windows PowerShell V5/V5.1 and then we will dive into detailing what's new in System Center 2016 and how you can take advantage of Microsoft Operations Management Suite to have a complete hybrid management experience. Finally, we will look at the new server

management tools for managing Windows servers from a web GUI or command-line tools.

Windows PowerShell improvements

Windows PowerShell is the de facto standard for managing Microsoft technologies. With increased support across our private and public cloud offerings, you will not find a single management solution that provides the vast capabilities that Windows PowerShell offers today. It has become so popular, in fact, that many third-party vendors are including Windows PowerShell support directly with their application portfolio. Windows PowerShell now has been open-sourced, which means the community can get involved and contribute to it and make it even better than before. Another fantastic area that Microsoft announced in 2016 is support for Linux. Now, you can use the same interfaces and coding standards you have developed in Windows PowerShell to manage your Linux environments. The future is bright for Windows PowerShell and these improvements reflect the

investment Microsoft is making to ensure that it is not just the primary choice for managing Windows Environments, but Linux, as well.

Windows PowerShell is part of the Windows Management Framework. Version 5.1 will be released with Windows Server 2016 but is backward compatible with Windows 7 up to 2012 R2.

We cover some of the newer features throughout this chapter for 5 and 5.1 to ensure we give coverage of the most interesting topics. However, a useful link in all Windows PowerShell user's arsenal should be

<http://microsoft.com/PowerShell>. This one stop resource gives you access to the following:

- Windows PowerShell Gallery
<http://www.powershellgallery.com/>
- Windows PowerShell Blog
<https://blogs.msdn.microsoft.com/powershell/>
- Windows PowerShell Repo on GitHub
<https://github.com/PowerShell/PowerShell>

In addition, you can do the following:

- Download Windows Management Framework

<https://www.microsoft.com/en-us/download/details.aspx?id=50395>

- Review the Windows PowerShell Documentation

<https://msdn.microsoft.com/en-us/powershell/scripting/powershell-scripting>

- Give feedback to the Windows PowerShell team

<https://windowsserver.uservice.com/forums/301869-powershell>

And much more...

Here are just some of the new (or improved) features for Windows PowerShell that we discuss:

- Package management
- Windows PowerShell Classes
- Windows PowerShell script debugging
- Desired State Configuration

For a full walkthrough on what is available in WMF 5.0 and WMF 5.1, check the following links:

WMF 5.0

<https://msdn.microsoft.com/powershell/wmf/5.0/releasenotes>

WMF 5.1

<https://msdn.microsoft.com/powershell/wmf/5.1/release-notes>

Package management

If you think of how you would traditionally install software on Windows today, there are a variety of ways. For example, you could get an .exe file or a .msi file to perform the installation. These files might have dependencies that come in different packages or are dependent on patches with .msu extensions. In short, installing software can be difficult. In Linux, this problem has been solved through package management using managers like APT-GET, YUM, and so on. These managers understand the software you are trying to install, retrieve all its dependencies, and then install the software.

Like Linux, we have some common terms that we use for our package management implementation:

- **Package** An automated software install, including PowerShell items
- **Repository** A storage location for packages, online or on-site
- **Package Manager** A command line interface to install packages
- **Provider** Code that knows how to talk to a repository
- **Source/Gallery** A repository holding software to download and install

These are just standard glossary terms, but they are helpful in understand package management in general.

In the next section, we dive into using Windows PowerShellGet and Nuget to facilitate the installation of our packages and give you more technical detail about them.

Windows PowershellGet and NuGet

The traditional way to install a Windows PowerShell module is to search for it on the Internet and then download and install it. Windows Server 2016 changes the way modules are managed on a machine. It comes with the PowershellGet Windows PowerShell module built in. PowershellGet helps you to find, download, install, and manage modules on a machine.

PowershellGet works with multiple providers. These providers are client tools that connect to the module repository represented by Source (location - URI). The most important provider PowershellGet works with as of Windows Server 2016 is NuGet. NuGet is the package manager for Windows; it provides the ability to consume not only modules, but also applications and packages. NuGet can work with multiple sources, but PSGallery is the most common and preferred repository source for PowershellGet.

All the functionality for module management is included in the PowershellGet module. The first step for managing modules is to import the module into the Windows PowerShell console. To do that, start the Windows PowerShell Integrated Scripting Environment (ISE) and then

run the following command to load the PowershellGet module:

```
PS C:\users\me>> import-module PowershellGet - Verbose
```

```
VERBOSE: Loading module from path PS
C:\WINDOWS\system32> import-module PowerShellGet -
Verbose
VERBOSE: Loading module from path 'C:\Program
Files\WindowsPowerShell\Modules\PowerShellGet\1.0.0.
1\PowerShellGet.psd1'.
VERBOSE: Loading 'FormatsToProcess' from path
'C:\Program
Files\WindowsPowerShell\Modules\PowerShellGet\1.0.0.
1\PSGet.Format.ps1xml'.
VERBOSE: Loading module from path 'C:\Program
Files\WindowsPowerShell\Modules\PowerShellGet\1.0.0.
1\PSModule.psm1'.
VERBOSE: Importing function 'Find-Command'.
VERBOSE: Importing function 'Find-DscResource'.
VERBOSE: Importing function 'Find-Module'.
VERBOSE: Importing function 'Find-RoleCapability'.
VERBOSE: Importing function 'Find-Script'.
VERBOSE: Importing function 'Get-InstalledModule'.
VERBOSE: Importing function 'Get-InstalledScript'.
VERBOSE: Importing function 'Get-PSRepository'.
VERBOSE: Importing function 'Install-Module'.
VERBOSE: Importing function 'Install-Script'.
VERBOSE: Importing function 'New-ScriptFileInfo'.
VERBOSE: Importing function 'Publish-Module'.
VERBOSE: Importing function 'Publish-Script'.
VERBOSE: Importing function 'Register-PSRepository'.
VERBOSE: Importing function 'Save-Module'.
VERBOSE: Importing function 'Save-Script'.
VERBOSE: Importing function 'Set-PSRepository'.
VERBOSE: Importing function 'Test-ScriptFileInfo'.
VERBOSE: Importing function 'Uninstall-Module'.
VERBOSE: Importing function 'Uninstall-Script'.
VERBOSE: Importing function 'Unregister-
PSRepository'.
VERBOSE: Importing function 'Update-Module'.
VERBOSE: Importing function 'Update-ModuleManifest'.
VERBOSE: Importing function 'Update-Script'.
```

```
VERBOSE: Importing function 'Update-ScriptFileInfo'.  
VERBOSE: Importing alias 'fimo'.  
VERBOSE: Importing alias 'inmo'.  
VERBOSE: Importing alias 'pumo'.  
VERBOSE: Importing alias 'upmo'.
```

Using the Verbose switch with the Import-Module cmdlet displays all imported functions, cmdlets, and aliases on the console. There are eight functions, two variables, and four aliases available in this module.

The first time you use the PowershellGet cmdlet, it verifies the installation of NuGet on the machine. If NuGet is not installed, a confirmation message box appears, as follows:

```
PowershellGet requires NuGet_anycpu.exe to interact  
with NuGet-based galleries. NuGet_anycpu.exe must be  
available in  
'C:\ProgramData\OneGet\ProviderAssemblies' or  
'C:\Users\\AppData\Local\OneGet\ProviderAs  
semblies'. For more information about NuGet, see  
http://www.nuget.org. Do you want PowershellGet to  
download NuGet_anycpu.exe now?
```

Clicking Yes downloads and installs NuGet on the machine.

The cmdlets provided by PowershellGet are divided into two broad categories: modules and repository cmdlets. PowershellGet provides cmdlets for finding, installing, publishing, and updating modules from the repository. It also provides cmdlets for reading current repository

settings as well as updating, registering, and unregistering them.

Two repositories are available by default: PSGallery and MSPSGallery. PowershellGet uses the NuGet provider to connect to these repositories. Running Get-PSRepository displays all existing repositories on the machine.

```
PS C:\users\me>> Get-PSRepository
```

Name	SourceLocation	InstallationPolicy
OneGetProvider		
-----	-----	-----
PSGallery	https://msconfiggallery.cloudapp.net/api/v2/	NuGet
	Untrusted	
MSPSGallery	http://www.microsoft.com/	
	NuGet	Trusted

Running the Get-PSRepository cmdlet with a repository name displays configurations related to that repository.

```
PS C:\WINDOWS\system32> get-PSRepository -name
PSGallery |Format-list *
Name : PSGallery
SourceLocation :
https://www.powershellgallery.com/api/v2/
Trusted : False
Registered : True
InstallationPolicy : Untrusted
PackageManagementProvider : NuGet
PublishLocation :
https://www.powershellgallery.com/api/v2/package/
ScriptSourceLocation :
https://www.powershellgallery.com/api/v2/items/pssc
ip
ScriptPublishLocation :
```

```
https://www.powershellgallery.com/api/v2/package/  
ProviderOptions : {}
```

Within the output, `SourceLocation` indicates the URL of the repository location, `PackageManagementProvider` identifies the package provider used to connect to the repository (NuGet in this case), `Trusted` indicates whether the repository is trusted, and `PublishLocation` shows the URL used for submission of modules.

Running the `Set-PSRepository` cmdlet sets the configuration values of a repository. For example, the `Set-PSRepository` cmdlet that follows changes the configuration value `Untrusted` to `Trusted` for the `PSGallery` repository. After changing a value, you can review the new configuration by running the `Get-PSRepository` cmdlet.

```
PS C:\Users\me> Set-PSRepository -Name "PSGallery" -  
InstallationPolicy Trusted
```

```
PS C:\Users\me> Get-PSRepository
```

Name	InstallationPolicy
SourceLocation	-----
-----	-----
PSGallery	Trusted
https://www.powershellgallery.com/api/v2/	

You use the `Register-PSRepository` cmdlet to add and register a new repository. To work

properly with the repository, the cmdlet needs the name of the repository, its source location for downloading modules, the publish location for publishing new modules to the repository, an installation policy, and the package manager. Running this cmdlet with Chocolatey as the name, `http://chocolatey.org/api/v2/` as both source and publish location, `Trusted` as the installation policy value, and `NuGet` as the package manager Name adds a new module repository to the machine, as follows:

```
Register-PSRepository -Name "Chocolatey" -
SourceLocation "http://chocolatey.org/api/v2/" `
-PublishLocation
"http://chocolatey.org/api/v2/" -InstallationPolicy
Trusted `
-PackageManagementProvider NuGet
```

After registering, the `Find-Module` cmdlet can search repositories, and the `Install-Module` cmdlet can download and install modules. Chocolatey is shown here just as an example; it can be any repository hosting Windows PowerShell modules.

Running `Unregister-PSRepository` with the `Name` parameter removes a previously registered repository.

```
PS C:\Users\me> Unregister-PSRepository -Name
Chocolatey
```

The most important function of the PowershellGet module is to find and install modules. Running the Find-Module cmdlet without any parameter outputs all of the modules available within all the repositories, as shown here:

```
PS C:\Users\me> Find-Module
```

Version	Name	Repository
2.0.1	AzureRM.profile	PSGallery
Microsoft	Azure PowerShell - Profile credential ...	
2.0.1	Azure.Storage	PSGallery
Microsoft	Azure PowerShell - Storage service cmd...	
1.7.6	Posh-SSH	PSGallery
PowerShell	module for automating tasks using the...	
2.0.1	AzureRM	PSGallery
	Azure Resource Manager Module	
..		
..		

Running the Find-Module cmdlet with the Name parameter outputs modules related to that name. Running this cmdlet with Bing as the value for the Name parameter provides information about Bing, as shown here:

```
PS C:\Users\me> Find-Module -Name "Bing"
```

Version	Name	Repository	
5.0	Bing	PSGallery	A few
functions	for working with the new Bing APIs		
5.0	Bing	Chocolatey	A few

functions for working with the new Bing APIs

```
PS C:\Users\me> Find-Module -Name "*ing"
```

Version	Name	Repository
2.11.0.0	xNetworking	PSGallery
0.9.4	AzureRM.MachineLearning	PSGallery
1.0.0.0	xWindowsEventForwarding	PSGallery
2.5.2	PSLogging	PSGallery
1.2.1	PowerShellLogging	PSGallery
5.0	Bing	PSGallery
2.0.1	Remote_PSRemoting	PSGallery

Module with DSC Resources for Networking area

Microsoft Azure PowerShell - Machine Learning We..

This module can be used to manage configuration ..

Creates and manages log files for your scripts.

Captures PowerShell console output to a log file.

A few functions for working with the new Bing APIs

Enable PSRemoting Remotely using WMI

Note The Name parameter also accepts wildcard characters.

The Find-Module cmdlet takes the additional parameters `MinimumVersion` and `RequiredVersion`. You cannot use them both at the same time. To download a specific version, use the `RequiredVersion` parameter. Specify `MinimumVersion` to download the most recent version higher or equal to the `MinimumVersion`. Running the Find-Module cmdlet with `Bing` as the value for the Name parameter and `4.0` as the value for the `MinimumVersion` parameter finds the Bing module with `5.0` as the output.

```
PS C:\Users\me> Find-Module -Name "Bing" -
MinimumVersion "4.0"
```

Version	Name	Repository	Description
5.0	Bing	PSGallery	A few functions for working with the new Bing APIs
5.0	Bing	Chocolatey	A few functions for working with the new Bing APIs

Running the Find-Module cmdlet with Bing as the value for the Name parameter and 4.0 as the value for the RequiredVersion parameter results in an error:

```
PS C:\Users\me> Find-Module -Name "Bing" -
RequiredVersion "6.0"
PackageManagement\Find-Package : No match was found
for the specified search criteria and module name
'Bing'. Try
Get-PSRepository to see all available registered
module repositories.
At C:\Program
Files\WindowsPowerShell\Modules\PowerShellGet\1.0.0.
1\PSModule.psm1:1249 char:3
+ PackageManagement\Find-Package
@PSBoundParameters | Microsoft ...
+
~~~~~
+ CategoryInfo          : ObjectNotFound:
(Microsoft.PowerShell.Commands.FindPackage:FindPackage)
[Find-Package], Exceptio
n
+ FullyQualifiedErrorId :
NoMatchFoundForCriteria,Microsoft.PowerShell.Package
Management.Cmdlets.FindPackage
```

However, running the Find-Module cmdlet with Bing as the value for the Name parameter and 5.0

as the value for the `RequiredVersion` parameter results in output with details about the Bing module:

```
PS C:\Users\me> Find-Module -Name "Bing" -
RequiredVersion "5.0"
```

Version	Name	Repository	
5.0	Bing	PSGallery	A few
5.0	Bing	Chocolatey	A few

After finding the relevant modules, the next step is to install the module. `PowershellGet` provides the `Install-Module` cmdlet specifically for this purpose. This cmdlet is very similar to `Find-Module`. It also takes `Name`, `RequiredVersion`, and `MinimumVersion` as parameters.

The code block that follows demonstrates running `Install-Module` with the `Name` parameter and the `Verbose` switch. You can use `MinimumVersion` or `RequiredVersion` along with the `Name` parameter. Notice that the last line in the output suggests that the module is installed. Also, note that the modules are downloaded by default at the `$env:ProgramFiles\WindowsPowerShell\Modules` folder location. Windows PowerShell uses this folder location to install modules.

```
PS C:\Users\me> Install-Module -Name bing -
Repository PSGallery -Verbose -AllowClobber
```

```
VERBOSE: Repository details, Name = 'PSGallery',
Location =
'https://www.powershellgallery.com/api/v2/';
IsTrusted =
'True'; IsRegistered = 'True'.
VERBOSE: Using the provider 'PowerShellGet' for
searching packages.
VERBOSE: Using the specified source names :
'PSGallery'.
VERBOSE: Getting the provider object for the
PackageManagement Provider 'NuGet'.
VERBOSE: The specified Location is
'https://www.powershellgallery.com/api/v2/' and
PackageManagementProvider is 'NuGet'.
VERBOSE: Searching repository
'https://www.powershellgallery.com/api/v2/FindPackag
esById()?id='bing'' for ''.
VERBOSE: Total package yield:'1' for the specified
package 'bing'.
VERBOSE: Performing the operation "Install-Module"
on target "Version '5.0' of module 'Bing'".
VERBOSE: The installation scope is specified to be
'AllUsers'.
VERBOSE: The specified module will be installed in
'C:\Program Files\WindowsPowerShell\Modules'.
VERBOSE: The specified Location is 'NuGet' and
PackageManagementProvider is 'NuGet'.
VERBOSE: Downloading module 'Bing' with version
'5.0' from the repository
'https://www.powershellgallery.com/api/v2/'.
VERBOSE: Searching repository
'https://www.powershellgallery.com/api/v2/FindPackag
esById()?id='Bing'' for ''.
VERBOSE: Searching repository
'https://www.powershellgallery.com/api/v2/FindPackag
esById()?id='BetterCredentials'' for
''.
VERBOSE: InstallPackage' - name='BetterCredentials',
version='4.4', destination='C:\Users\johm\AppData\Loc
al\Temp\1152878524'
VERBOSE: DownloadPackage' -
name='BetterCredentials',
```

```
version='4.4',destination='C:\Users\johm\AppData\Local\Temp\1152878524\BetterCredentials\BetterCredentials.nupkg',
uri='https://www.powershellgallery.com/api/v2/package/BetterCredentials/4.4.0'
VERBOSE: Downloading
'https://www.powershellgallery.com/api/v2/package/BetterCredentials/4.4.0'.
VERBOSE: Completed downloading
'https://www.powershellgallery.com/api/v2/package/BetterCredentials/4.4.0'.
VERBOSE: Completed downloading 'BetterCredentials'.
VERBOSE: InstallPackageLocal' -
name='BetterCredentials',
version='4.4',destination='C:\Users\johm\AppData\Local\Temp\1152878524'
VERBOSE: InstallPackage' - name='Bing',
version='5.0',destination='C:\Users\johm\AppData\Local\Temp\1152878524'
VERBOSE: DownloadPackage' - name='Bing',
version='5.0',destination='C:\Users\johm\AppData\Local\Temp\1152878524\Bing\Bing.nupkg',
uri='https://www.powershellgallery.com/api/v2/package/Bing/5.0.0'
VERBOSE: Downloading
'https://www.powershellgallery.com/api/v2/package/Bing/5.0.0'.
VERBOSE: Completed downloading
'https://www.powershellgallery.com/api/v2/package/Bing/5.0.0'.
VERBOSE: Completed downloading 'Bing'.
VERBOSE: InstallPackageLocal' - name='Bing',
version='5.0',destination='C:\Users\johm\AppData\Local\Temp\1152878524'
VERBOSE: Catalog file 'BetterCredentials.cat' is not found in the contents of the module
'BetterCredentials' being installed.
VERBOSE: Installing the dependency module
'BetterCredentials' with version '4.4' for the module 'Bing'.
VERBOSE: Module 'BetterCredentials' was installed successfully to path 'C:\Program
Files\WindowsPowerShell\Modules\Better\Credentials\4.4'.
VERBOSE: Catalog file 'Bing.cat' is not found in the
```

```
contents of the module 'Bing' being installed.  
VERBOSE: Module 'Bing' was installed successfully to  
path 'C:\Program  
Files\WindowsPowerShell\Modules\Bing\5.0'.
```

At this point, you can use the Bing module by importing it into the current Windows PowerShell runspace by using the `Import-Module` cmdlet. After the initial installation, running `Update-Module` updates the existing modules. This module takes the `Name` and `RequiredVersion` parameters, but it does not take the `MinimumVersion` parameter, as shown here:

```
PS C:\Users\me> Update-Module -Name Bing  
PS C:\Users\me> Update-Module -Name "Bing" -  
RequiredVersion "5.0"
```

There is also a `Publish-Module` cmdlet for adding newer modules to the repository.

Windows PowerShell Classes

Windows PowerShell Classes provides a new method to extend the management surfaces of Windows PowerShell for developers and IT professionals alike. Using PowerShell Classes, these audiences can create Windows PowerShell artifacts in a traditional manner using formal syntax and semantics from object-orientated programming.

For example, developers would be familiar with such constructs as classes or methods. Now Windows PowerShell makes it possible for you to define these natively within the language for future use.

Windows PowerShell Classes, although not a level 200 topic that this book mainly covers, is an important improvement in the journey of Windows PowerShell so that its appeal to wider audiences becomes more apparent.

Here are some other elements that Windows PowerShell Classes support:

- Define Desired State Configuration resources by using the native Windows PowerShell language
- Define custom types (i.e., classes, properties, and methods)
- Support debug types
- Generate and handle exceptions using formal methods

Now this might seem extremely advanced right now, but we include it today to ensure that you are aware of the evolution of Windows PowerShell and how it can become an

underpinning technology to line-of-business applications today.

More info To read more about creating custom types using Windows PowerShell, go to http://msdn.microsoft.com/powershell/wmf/5.0/class_overview.

Windows PowerShell script debugging

Windows Server 2016 introduced several improvements for script debugging introduced for Windows PowerShell:

- Break All
- Remote editing
- Remote debugging
- Job debugging
- Runspace debugging
- Remote Desired State Configuration debugging

Let's look into each element in more detail.

Break All

Break All is a very useful function to stop a script as it's running so that we can dive into the debugger to find out how the script is running and what the current state of the variables and other elements are. Support has been included for both the Windows PowerShell console and the ISE.

To use the debugger in a console session, press **Ctrl+Break**

In the Windows PowerShell ISE, you can press **Ctrl+B** or, on the menu, click **Debug** and then click **Break All**.

Remote editing

With the current Windows PowerShell ISE, you can open and directly edit a file in a remote Windows PowerShell session. Using a new command called **PSEdit**, we can directly edit files locally and in remote sessions. The following code shows a sample in action:

```
[Cloud01]: PS C:\> PSEdit C:\WinDemo\Get-ComputerInfo.ps1
```

When you execute **PSEdit**, it will open the file in the ISE where you can make changes and save

them to the remote machine and reexecute the code.

Remote debugging

Extending on to the capabilities of remote editing, you can now debug a script running in a remote session with the ISE.

The `Set-PsBreakpoint` cmdlet sets the breakpoint in the code and then you use the `Write-Debug` cmdlet to output some information for use in your scripts when you encounter a break point. This drops you into the debugger at that point to perform some additional work and look at the available information. Figure 5-1 shows this in operation.

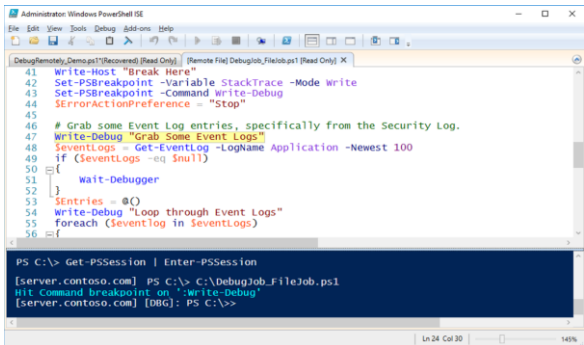

```
Administrator: Windows PowerShell ISE
File Edit View Tools Debug Add-ons Help
DebugRemotely_Demos1\Recovered [Read Only] [Remote File] DebugJob_FileJob.ps1 [Read Only] X
41 Write-Host "Break Here"
42 Set-PsBreakpoint -Variable StackTrace -Mode Write
43 Set-PsBreakpoint -Command write-Debug
44 $ErrorActionPreference = "Stop"
45
46 # Grab some Event Log entries, specifically from the Security Log.
47 Write-Debug "Grab Some Event Logs"
48 $eventLogs = Get-EventLog -LogName Application -Newest 100
49 if ($eventLogs -eq $null)
50 {
51     Write-Debugger
52 }
53 $entries = @()
54 Write-Debug "Loop through Event Logs"
55 foreach ($eventlog in $eventLogs)
56 {
PS C:\> Get-PSSession | Enter-PSSession
[server.contoso.com] PS C:\> C:\DebugJob_FileJob.ps1
Hit Command breakpoint on 'write-Debug'
[server.contoso.com] [DBG]: PS C:\>>
```

Figure 5-1: Sample code in the Windows Powershell ISE with remote debugging

When a script encounters a breakpoint in a remote session, it will display a message indicating it has done so. Figure 5-2 illustrates a sample message.

```
WARNING: Session has been disconnected...script has stopped at a breakpoint. Use the Enter-PSSession connect begin interactive debugging.
```

Figure 5-2: Breakpoint warning in a remote session

Not all remote sessions will support a remote debug session, but when you connect to the remote session using the `Connect-PSSession` cmdlet, you will see the output shown in Figure 5-3. The output also lets you know whether it is available.

```
PS C:\> Get-PSSession | Connect-PSSession
```

Id	Name	ComputerName	State	ConfigurationName	Availability
1	Session1	server.contoso.com	Opened	Microsoft.PowerShell	RemoteDebug

Figure 5-3: Remote debug availability

If remote debug is available, you can connect to the session by using the `Enter-PSSession` cmdlet, which connects you directly to the debugger

```
PS C:\> Get-PSSession | Enter-PSSession
```

```
WARNING: You have entered a session that is currently stopped at a debug breakpoint inside a running command or script. Use the Windows PowerShell command line debugger to continue debugging.
```

```
Hit Line breakpoint on 'C:\DebugJob_FileJob.ps1:41'
```

```
[server.contoso.com] [DBG]: PS C:\>>
```

Figure 5-4: Remote debugger in action

Job debugging

One useful function in Windows PowerShell is the ability to execute scripts as background jobs. These jobs can run without clogging up the main console screen, letting you proceed with additional tasks. This was fine, but these jobs could sometimes be difficult to troubleshoot and could require a lot of trial and error in order to develop robust scripts that could truly be run as jobs.

Now, with Server 2016, Windows PowerShell introduces the `Debug-Job` cmdlet, which gives you the ability to debug these background jobs more effectively. Figure 5-5 shows this cmdlet being used. Note how `Debug-Job` shows you the line and character at which the job broke.

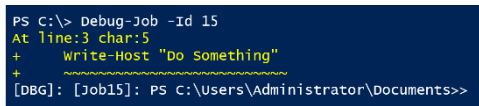
A screenshot of a PowerShell console window with a dark blue background. The text is white and yellow. It shows a command being executed: 'PS C:\> Debug-Job -Id 15'. Below that, it shows the output of the job: 'At line:3 char:5', followed by a plus sign and the command 'write-Host "Do something"'. A red squiggly line is under the 'e' in 'something'. Below that, it shows the debug prompt: '[DBG]: [Job15]: PS C:\Users\Administrator\Documents>>'.

```
PS C:\> Debug-Job -Id 15
At line:3 char:5
+ write-Host "Do something"
+ ~~~~~
[DBG]: [Job15]: PS C:\Users\Administrator\Documents>>
```

Figure 5-5: The `Debug-Job` cmdlet outputting an error in a background job

To get to this break state, the same cmdlet `Set-PSBreakPoint` or `Wait-Debugger` is used to “pause” the script and enter the debugger. You can type these cmdlets into your script and then verify the state of the job so that you can verify if

it has encountered the breakpoint and is ready to debug. Figure 5-6 shows you a sample of this.

```
PS C:\> Get-Job

Id      Name      PSJobTypeName      State      HasMoreData      Location      Command
-----
7       Job7      BackgroundJob      AtBreakpoint True             localhost     wait-Debugger

PS C:\> Debug-Job -Id 7
```

Figure 5-6: Background Job State

Runspace debugging

Runspace were introduced to solve a few problems that background jobs had introduced, such as resources issues and performance problems. Runspaces are different from jobs in that they generate a new thread of execution for the environment which doesn't come with the same overhead as a background job.

More info For more information on runspaces and how to use them, go to <http://blogs.technet.microsoft.com/heyscriptingguy/2015/11/26/beginning-use-of-powershell-runspace-part-1/>.

Figure 5-7 depicts a runspace being created.

```

PS C:\> $runspace = [runspacefactory]::CreateRunspace()
PS C:\> $runspace.Name = "MyRunspace"
PS C:\> $runspace.Open()
PS C:\> $powershell = [powershell]::Create()
PS C:\> $powershell.Runspace = $runspace
PS C:\> $powershell.AddScript("DebugJob_FileJob.ps1")
PS C:\> $asynchandle = $powershell.BeginInvoke()

```

Figure 5-7: Creating a runspace

Much like jobs, to debug a runspace, you need to obtain its "ID." Figure 5-8 shows the available runspaces and then entering the debug session using the Debug-Runspace cmdlet.

```

PS C:\> Get-Runspace

```

Id	Name	ComputerName	Type	State	Availability
1	Runspace1	localhost	Local	Opened	Busy
2	MyRunspace	localhost	Local	Opened	InBreakpoint

```

PS C:\> Debug-Runspace -Id 2
Debugging Runspace: MyRunspace
To end the debugging session type the 'Detach' command at the debugger prompt,
or type 'Ctrl+C' otherwise.

[DBG]: [Process:12008]: [MyRunspace]: PS C:\

```

Figure 5-8: Debugging a runspace

The first runspace, ID 1, is always the original Windows PowerShell session you are in. Use the previous referenced link to dive deeper into runspaces for your environment.

Desired State Configuration

Windows PowerShell Desired State Configuration (DSC) is a hot topic nowadays. DSC is a new configuration management platform with which administrators can use Windows PowerShell for deploying and managing software services and also for managing the environment in which these services run. Windows Server 2016 introduces several improvements to DSC, and in this chapter, we dive into two of these enhancements: the new Local Configuration Manager and a new partial configuration feature.

DSC Local Configuration Manager

One key component of DSC is Local Configuration Manager (LCM), the DSC engine responsible for processing and enacting configuration documents (.mof files).

LCM accepts (push mode), retrieves (pull mode), applies, monitors, compares, reports the drifts, and applies (or reapplies) the configuration documents. Needless to say, LCM is the heart and brain of DSC.

Windows Server 2016 comes preinstalled with Windows Management Framework 5.1 and DSC. DSC was introduced with Windows Management Framework 4.0 (also available for download for earlier Windows Versions) and came preinstalled in Windows Server 2012 R2 and Windows 8.1. As you might expect, Windows Management Framework 5.1 introduces many new features and changes to DSC and LCM.

You can configure LCM and the DCS engine by applying a *Meta Configuration* document (meta.mof). The behavior and actions of LCM can be influenced and controlled by modifying Meta Configuration properties.

DSC v2 in Windows Server 2016 builds on the previous version, deprecating a few LCM properties and offering newer cmdlets for managing configurations, a newer LCM with additional functionality, newer Meta Configuration attributes, and new features such as partial configurations and cross-machine synchronization.

LCM is implemented as a Common Information Model (CIM) class `MSFT_DSCLocalConfigurationManager` within the `root\Microsoft\Windows\DesiredStateConfiguration` namespace.

In this section, we look into the newer functionality and workings of LCM v2 on Windows Server 2016.

DSC provides two cmdlets for accessing LCM and viewing and updating the LCM properties: `Get-DSCLocalConfigurationManager` for viewing and `Set-DSCLocalConfigurationManager` for setting. Running `Get-DSCLocalConfigurationManager` on the Windows Server 2016 Windows PowerShell console lists all LCM Meta Configuration properties along with their current values. The default values are shown in the following output:

```
PS C:\> Get-DscLocalConfigurationManager
```

```
ActionAfterReboot           :  
ContinueConfiguration       :  
AgentId                     : C8F7308B-6E6D-11E6-  
899F-B4AE2BEB7DE5  
AllowModuleOverWrite        : False  
CertificateID               :  
ConfigurationDownloadManagers : {}  
ConfigurationID            :  
ConfigurationMode           : ApplyAndMonitor  
ConfigurationModeFrequencyMins : 15  
Credential                  :  
DebugMode                   : {NONE}  
DownloadManagerCustomData   :  
DownloadManagerName         :  
LCMCompatibleVersions       : {1.0, 2.0}  
LCMState                    : Idle  
LCMStateDetail              :  
LCMVersion                   : 2.0  
StatusRetentionTimeInDays   : 10  
SignatureValidationPolicy    : NONE
```

```
SignatureValidations           : {}
MaximumDownloadSizeMB         : 500
PartialConfigurations          :
RebootNodeIfNeeded             : False
RefreshFrequencyMins           : 30
RefreshMode                     : PUSH
ReportManagers                 : {}
ResourceModuleManagers         : {}
PSComputerName                 :
```

LCM in Windows Server 2016 includes all of the properties from the first version for backward compatibility. Most of these properties are needed in the newer version, whereas others are deprecated and cannot be used for configuring LCM in Windows PowerShell V5.

More info For a complete reference on all the Meta Configuration properties available and for the latest information, go to <https://msdn.microsoft.com/powershell/dsc/metaconfig>.

With the new LCM properties, it is possible to have multiple configuration fragments instead of a single configuration. The properties are more organized, each with well-defined usage. You can query the current state of the LCM, turn on and turn off caching, and separate URL endpoints for configurations and resources.

DSC in Windows PowerShell V4 used a special resource, `LocalConfigurationManager`, to set the LCM Meta Configuration properties. This

resource is deprecated in LCM in Windows PowerShell V5. You can still use it to configure LCM v2; however, it cannot configure the new Meta Configuration properties. It is recommended that you use the new Settings resource to set LCM properties, instead.

You set MetaConfiguration properties by performing a few steps in sequence. As mentioned, in LCM v2, you should use a new special resource named Settings to configure LCM Meta Configuration properties. You should place this new resource in a configuration script and run it. Running the resource generates a meta.mof file, which is sent to the LCM of the destination server. The LCM of the destination server applies and changes Meta Configuration property values. Note that the LCM configuration is not allowed in a regular configuration comprising general DSC resources. Along with the Settings resource, a few more LCM-specific resources are included in LCM v2. These LCM resources provide a better authoring experience and eventually change the properties available in the Settings resource. They are summarized as follows:

- **Settings** This is the primary LCM Meta Configuration resource.

- **ConfigurationRepositoryWeb** This resource represents the Internet Information Services (IIS) Open Data Protocol (OData) endpoint for pull servers. This resource changes the ConfigurationDownloadManagers property of the Settings resource. It has the following properties:

ConfigurationNames

ServerUrl

AllowUnsecureConnection

CertificateID

RegistrationKey

- **ConfigurationRepositoryShare** This resource represents the Server Message Block (SMB) share endpoint for pull servers. This resource changes the ConfigurationDownloadManagers property of the Settings resource. It has the following properties:

SourcePath

Credential

- **ResourceRepositoryWeb** This resource represents the IIS OData endpoint for

downloading DSC resources by using IIS. This resource changes the `ResourceModuleManagers` property of the `Settings` resource. It has the following properties:

`AllowUnSecureConnection`

`ServerUrl`

`CertificateID`

`RegistrationID`

- **ResourceRepositoryShare** This resource represents the IIS OData endpoint for downloading DSC resources by using SMB shares. This resource changes the `ResourceModuleManagers` property of the `Settings` resource. It has the following properties:

`SourcePath`

`Credential`

- **ReportServerWeb** This resource represents the IIS OData endpoint for providing reporting data related to nodes, their current configurations, and drifts. This resource changes the `ResourceModuleManagers` property of the

Settings resource. It has the following properties:

ServerUrl

CertificateID

RegistrationKey

AllowUnsecureConnection

- **PartialConfiguration** This resource represents the name of the configuration that should be pulled from the pull server. It is possible to have multiple `PartialConfiguration` resources in a configuration. This resource changes the `PartialConfigurations` property of the Settings resource. It has the following properties:

DependsOn

RefreshMode

RefreshModuleSource

Description

ExclusiveResources

ConfigurationSource

More info For a detailed overview of the previous blocks, go to <https://msdn.microsoft.com/powershell/dsc/metaconfig>.

The following is a typical implementation of a Meta Configuration property configuration in LCM v2:

```
[DSCLocalConfigurationManager()]
Configuration ChangeLCMProperties
{
    Node DemoServerWin
    {
        Settings
        {
            AllowModuleOverwrite = $false
            RebootNodeIfNeeded = $true
            RefreshMode = "Pull"
            ConfigurationMode =
"ApplyAndAutoCorrect"
            ConfigurationID = "fcd03a8d-5a64-4982-
92b3-5c89680add39"
        }

        ConfigurationRepositoryWeb PullServer1
        {
            ServerURL =
"http://demoserverwin10:8090/PSDSCPullServer.svc/"
            AllowUnsecureConnection = $true
        }

        ConfigurationRepositoryWeb PullServer2
        {
            ServerURL =
"http://demoserverwin10:8080/PSDSCPullServer.svc/"
            AllowUnsecureConnection = $true
        }
    }
}
```

```

ReportServerWeb ComplianceServer
{
    ServerURL =
"http://demoserwin10:8000/PSDSCComplianceServer.s
vc/"
    AllowUnsecureConnection = $true
}

PartialConfiguration IISInstall
{
    Description          = 'Configuration for
IIS Web Server'
    ConfigurationSource =
'[ConfigurationRepositoryWeb]PullServer1'
}

PartialConfiguration IndexFile
{
    Description          = 'Configuration for
Index File'
    ConfigurationSource =
'[ConfigurationRepositoryWeb]PullServer2'
    DependsOn           =
'[PartialConfiguration]IISInstall'
}
}

ChangeLCMPProperties -OutputPath "C:\DSC"

Set-DscLocalConfigurationManager -Path "C:\DSC"

```

The preceding script is similar to general DSC configuration with the configuration named `ChangeLCMPProperties` but including the defined `DSCLocalConfigurationManager` attribute. This attribute mandates that all resources within the configuration should be related to LCM only and should be present on configurations related to LCM. An error results if other general resources

are used in the configuration. The script contains one node section for the DemoServerWin server.

The Settings resource is the main resource for setting the LCM properties. In this example, we are specifying some of its properties and assigning values to them. For example, the refresh mode is set to Pull so that the machine should restart (when required by a resource); the configuration mode has been changed to ApplyandAutoCorrect, and ConfigurationID has been provided with a valid GUID. The configuration as represented by the GUID would be pulled from the pull server.

There are two pull servers in this configuration denoted by PullServer1 and PullServer2. The ServerURL property shows that they are on the same server with different port numbers. Also, AllowUnsecureConnection makes it possible to use HTTP instead of HTTPS protocol. Compliance server information is also provided by using ReportServerWeb. There are two partial configurations set to be downloaded by LCM and applied as a single configuration on its server. Partial Configuration IISInstall is responsible for downloading a configuration named IISInstall from PullServer1. Partial Configuration IndexFile is responsible for downloading a configuration named IndexFile

from PullServer2. Moreover, running the partial configuration IndexFile depends on the completion of the configuration IISInstall as represented by the DependsOn property. Only after the IISInstall configuration is applied can the IndexFile configuration run.

After the configuration is defined, it runs to generate the .mof file (DemoServerWin.Meta.mof) at C:\DSC. The folder location has been explicitly provided by using the OutputPath parameter. After the .mof file is generated, the Set-DSCLocalConfigurationManager cmdlet is used to push and apply the .mof file to the DemoServerWin server.

When the configuration is applied, LCM on the server DemoServerWin is configured to pull partial configurations from multiple pull servers and apply them periodically.

Next, you can read the new configuration again by using Get-DSCLocalConfigurationManager, as shown in the following example:

```
PS C:\Users\me> Get-DscLocalConfigurationManager

ActionAfterReboot           :
ContinueConfiguration       :
AgentId                     :
C8F7308B-6E6D-11E6-899F-B4AE2BEB7DE5
AllowModuleOverWrite       : False
CertificateID               :
```



```

ConfigurationDownloadManagers      :
{[ConfigurationRepositoryWeb]PullServer1,
[ConfigurationRepositoryWeb]PullServer2}
ConfigurationID                    :
fcd03a8d-5a64-4982-92b3-5c89680add39
ConfigurationMode                   :
ApplyAndAutoCorrect                :
ConfigurationModeFrequencyMins     : 15
Credential                          :
DebugMode                           : False
DownloadManagerCustomData          :
DownloadManagerName                 :
LCMCompatibleVersions              : {1.0,
2.0}
LCMState                            : Ready
LCMVersion                          : 2.0
MaximumDownloadSizeMB              : 500
StatusRetentionTimeInDays          : 7
PartialConfigurations               :
{[PartialConfiguration]IISInstall,
[PartialConfiguration]IndexFile}
RebootNodeIfNeeded                 : True
RefreshFrequencyMins                : 30
RefreshMode                         : PULL
ReportManagers                      :
[ReportServerWeb]ComplianceServer  :
ResourceModuleManagers              : {}
PSComputerName                      :

```

In the preceding code block, the `ConfigurationDownloadManagers` property is filled with two values representing two pull servers: `PartialConfigurations` has two values represented by the `IISInstall` and `IndexFile` configurations, and `ReportManagers` has a value of `ComplianceServer`.

New methods in LCM

There are three new methods in LCM v2: `GetConfigurationStatus`, `GetConfigurationResultOutput`, and `SendConfigurationApplyAsync`. Let's examine these briefly.

GetConfigurationStatus

The `GetConfigurationStatus` method retrieves the current status of configuration for a server. The new DSC cmdlet `Get-DSCConfigurationStatus` invokes the CIM method. The following code shows an example of `Get-DSCConfigurationStatus`:

```
PS C:\> $cimsession = New-CimSession -ComputerName DemoServerWin10
PS C:\> Get-DscConfigurationStatus -CimSession $cimsession
```

Status	StartDate	Type
Mode	RebootRequested	
	NumberOfConfigurationResources	
PSComputerName		
-----	-----	-----
---	-----	-----
----	-----	-----
Success	2016/07/12 16:23:03	Consistency
PUSH	False	
	1	
DemoServerWin10		

GetConfigurationResultOutput

The `GetConfigurationResultOutput` method provides verbose information about the current configuration and the configuration drifts. There is no DSC cmdlet that invokes this CIM method. Instead, you can invoke it can by using the CIM cmdlet `Invoke-CIMMethod`, as shown here:

```
PS C:\>
$ConsistencyCheck = (Invoke-CimMethod -ClassName
"MSFT_DSCLocalConfigurationManager" `
                        -Namespace
"root\Microsoft\Windows\DesiredStateConfiguration" `
                        -MethodName
getConfigurationResultOutput)

for($i=0; $i -le 100; $i++)
{
    $ConsistencyCheck[$i].ItemValue.Message
}
[DEMOSERVERWIN10]:                                     []
Starting consistency engine.
[DEMOSERVERWIN10]: LCM: [ Start Resource ]
[[WindowsFeature]XPS]
[DEMOSERVERWIN10]: LCM: [ Start Test      ]
[[WindowsFeature]XPS]
[DEMOSERVERWIN10]:
[[WindowsFeature]XPS] Begin running Test
functionality on the XPS-Viewer feature.
[DEMOSERVERWIN10]:
[[WindowsFeature]XPS] Querying for feature XPS-
Viewer using Server Manager cmdlet Get-
WindowsFeature.
[DEMOSERVERWIN10]:
[[WindowsFeature]XPS] The operation 'Get-
WindowsFeature' started: XPS-Viewer
[DEMOSERVERWIN10]:
[[WindowsFeature]XPS] GetServerComponentsAsync
provider method started: XPS-Viewer
[DEMOSERVERWIN10]:
```

```

[[WindowsFeature]XPS] Call to
GetServerComponentsAsync provider method succeeded.
[DEMOSERVERWIN10]:
[[WindowsFeature]XPS] The operation 'Get-
WindowsFeature' succeeded: XPS-Viewer
[DEMOSERVERWIN10]:
[[WindowsFeature]XPS] End running Test functionality
on the XPS-Viewer feature.
[DEMOSERVERWIN10]: LCM: [ End    Test    ]
[[WindowsFeature]XPS] in 0.4667 seconds.
[DEMOSERVERWIN10]: LCM: [ End    Resource ]
[[WindowsFeature]XPS]
[DEMOSERVERWIN10]:                               []
Consistency check completed.

```

SendConfigurationApplyAsync

The `SendConfigurationApplyAsync` method applies the configuration to a target server asynchronously. This means LCM invokes this method and does not wait for its completion. Again, there is no DSC cmdlet to invoke this method; however, you can invoke it through a CIM cmdlet, as shown in the following example:

```

PS C:\> Configuration PushDemo
{
    Node DemoServerWin10
    {
        WindowsFeature XPS
        {
            Name = "XPS-Viewer"
            Ensure = "Absent"
        }
    }
}

PushDemo -OutputPath "C:\DSC"
$mofString = get-content
"C:\dsc\DemoServerWin10.mof"
$mofbytes =

```

```
[System.Text.Encoding]::ASCII.GetBytes($mofString)
$AsyncApply = Invoke-CimMethod -ClassName
"MSFT_DSCLocalConfigurationManager" `
    -Namespace
"root\Microsoft\Windows\DesiredStateConfiguration" `
    -MethodName
SendConfigurationApplyAsync `
    -Arguments
@{ConfigurationData=$mofbytes;Force=$true}
$AsyncApply
```

```
Directory: C:\DSC
Mode                LastWriteTime         Length
Name
----                -
-
-a-----          07/12/2016   2:28 PM           1226
DemoServerWin10.mof
PSComputerName :
```

DSC partial configurations

One of the most awaited and interesting features of DSC v2 is partial configuration. Until DSC v2, it was difficult to split a configuration into multiple configuration files authored for a server. Partial configuration makes it possible for you to split a configuration into multiple smaller configuration fragments across multiple files. Partial configurations are implemented exactly the same as any general DSC configuration. It is the responsibility of LCM on a destination server to combine all the configuration fragments into a single configuration and apply it.

Partial configurations are complete in and of themselves, and you can apply them independently as a complete configuration to any server. It is the LCM Meta Configuration that's configured on the target server that makes it possible for partial configurations to be applied to a server.

In Windows Server 2016, partial configurations work within DSC push and pull mode. This means that you should configure the LCM of servers in a network to pull configurations from a pull server (IIS or SMB share) and be able to identify the configurations distinctly on these pull servers.

The benefits of partial configurations include the following:

- Multiple authors can write configurations independently and simultaneously for servers in a network.
- You can apply incremental configurations to servers without modifying any existing configurations.
- Modular authoring of configurations is available.
- There are no longer dependencies on using only a single .mof file. This was the case in

DSC v1, for which only one .mof file was allowed and applied to a server at a given point of time. Newer configuration (.mof) would replace the current configuration in DSC v1.

To make partial configuration work in Windows Server 2016, complete the following steps:

1. Create the pull server.
2. Configure the LCM Meta Configuration of servers on the network.
3. Author the configurations.
4. Deploy the configurations on the pull server.

We will look into the details of each of these steps, except for the creation of the pull server because that process is the same as for DSC v1.

Setting up the LCM Meta Configuration

To prepare a server's LCM Meta Configuration, you must set the following:

- RefreshMode with the value of Pull.
- ConfigurationMode with any value to keep the server in the expected state.

- ConfigurationRepositoryWeb resource instance representing a pull server of either web or SMB.
- Multiple PartialConfiguration resource instances, each representing a configuration on a pull server.

In LCM, another Meta Configuration property you need to decide to set can be either ConfigurationID or ConfigurationName. Visit the following two links in reference to both properties:

- ConfigurationName
<https://msdn.microsoft.com/powershell/dsc/pullclientconfgnames>
- ConfigurationID
<https://msdn.microsoft.com/powershell/dsc/pullclientconfigid>

To demonstrate partial configuration, the following example features an environment with a pull server (DemoServerWin10). There are also two configurations, each deployed to one of the pull servers. The LCM of a destination machine is configured with these two pull servers and configurations. The LCM configuration applied to

the server named DemoServerWin is shown in the following:

```
[DSCLocalConfigurationManager()]
Configuration ChangeLCMPProperties
{
    Node DemoServerWin
    {
        Settings
        {
            RebootNodeIfNeeded = $true
            RefreshMode = "Pull"
            ConfigurationMode =
"ApplyAndAutoCorrect"
            ConfigurationID = "fcd03a8d-5a64-4982-
92b3-5c89680add39"
        }

        ConfigurationRepositoryWeb PullServer1
        {
            ServerURL =
"http://demoserverwin10:8080/PSDSCPullServer.svc/"
            AllowUnsecureConnection = $true
        }

        PartialConfiguration IISInstall
        {
            Description          = 'Configuration for
IIS Web Server'
            ConfigurationSource =
'[ConfigurationRepositoryWeb]PullServer1'
        }

        PartialConfiguration IndexFile
        {
            Description          = 'Configuration for
Index File'
            ConfigurationSource =
'[ConfigurationRepositoryWeb]PullServer1'
            DependsOn            =
'[PartialConfiguration]IISInstall'
        }
    }
}
```

```
ChangeLCMProperties -OutputPath "C:\DSC"  
Set-DscLocalConfigurationManager -Path "C:\DSC"
```

Assuming that the pull servers are already available on the mentioned servers, you must change the LCM Meta Configuration settings on all servers that will participate and pull configurations from them. The preceding configuration sample has a node section named `DemoServerWin`. It signifies that the configuration modifies the LCM configuration of `DemoServerWin`. The attribute `DscLocalConfigurationManager` mandates that only resources applicable for LCM Meta Configuration can be used in this configuration and that this is a Meta Configuration that will output a `.meta.mof` file. General resources cannot be used in such configurations. Using this attribute is the way to indicate to DSC that this configuration relates to LCM configuration.

The `Settings` resource is configured with the `RefreshMode` property set to `Pull`, the `ConfigurationMode` property set to `ApplyandAutoCorrect`, the `ConfigurationID` property set to `fcd03a8d-5a64-4982-92b3-5c89680add39`, and the `RebootNodeIfNeeded` property set to `True`. LCM downloads configuration files from the pull server whose name has the same GUID as that assigned to the

ConfigurationID. LCM would download configuration files with fcd03a8d-5a64-4982-92b3-5c89680add39 in their names from the pull server in the case of the preceding example.

You also need to provide the pull server details to LCM. In LCM v2, you can do so by using the `WebConfigurationRepository` resource. There can be multiple pull servers (`WebConfigurationRepository` resources) defined in a configuration. In the previous sample, two pull servers are defined: `PullServer1` with server URL `http://demoserverwin:8080/PSDSCPullServer.svc/` and `AllowUnsecureConnection` set to `True`, and `PullServer2` with server URL `http://Demoserverwin10:8090/PSDSCPullServer.svc/` and `AllowUnsecureConnection` set to `True`. Although this example shows a property called `AllowUnsecureConnection`, and setting it to `True` allows LCM to request configuration on HTTP protocol instead of HTTPS protocol, we strongly recommend that you use HTTPS in normal operating environments.

The `PartialConfiguration` resource defines configuration fragments. Two partial configurations, `IISInstall` and `IndexFile`, are defined. `IISInstall` configuration is available on `PullServer1`, whereas `IndexFile` configuration is

available on PullServer2. Important to note are the names of the partial configurations because they should exactly match the names of the configurations on the pull server. The next section will show that the IISInstall configuration is authored and available on PullServer1 and the IndexFile configuration is available on PullServer1. The ConfigurationSource property attaches the pull server to the partial configuration.

Also, note that the pull server URL, ConfigurationID, and Configuration Name combined provide the LCM with complete information to uniquely identify the configuration on the pull server. The LCM cannot pull partial configurations if any of these three pieces of information is missing.

The configuration previously shown generates the DemoServerWin.meta.mof file at the C:\DSC folder location. You use the Set-DSCLocalConfigurationManager cmdlet to push and apply the .mof file to DemoServerWin.

Authoring the configurations

Next, we examine authoring the configurations that will participate in partial configuration. In

this section, two configurations, IISInstall and IndexFile, are authored.

IISInstall configuration

This is a simple configuration responsible for installing IIS (Web-Server) on a server using the WindowsFeature resource. Running the configurations in this section and the next one generates .mof files. The configuration script in our sample that follows runs on server ServerWin10. The name of the .mof file is same as the node name defined in the configuration script. Configurations participating in partial configurations have a special naming requirement. They must use the *<ConfigurationName>.<ConfigurationID>.mof* format. The configuration shown in the following sample uses ConfigurationData (data structure for passing values to configuration script) to define the name of the node.

`$AllNodes.NodeName` retrieves all the node names from the configuration data, which in this case is only one because there is just one `NodeName`. `IISInstall.fcd03a8d-5a64-4982-92b3-5c89680add39.MOF` is generated from the following script:

```
$ConfigInfoIIS = @{
    AllNodes = @(
        @{
            NodeName = "IISInstall.fcd03a8d-5a64-
```

```
4982-92b3-5c89680add39"  
    }  
  )  
}
```

```
Configuration IISInstall  
{  
  Node $AllNodes.NodeName  
  {  
    WindowsFeature IIS  
    {  
      Name = "Web-server"  
      Ensure = "Present"  
    }  
  }  
}
```

```
IISInstall -OutputPath 'C:\Program  
Files\WindowsPowerShell\DscService\Configuration' -  
ConfigurationData $ConfigInfoIIS
```

```
New-DSCChecksum -ConfigurationPath 'C:\Program  
Files\WindowsPowerShell\DscService\Configuration' -  
OutPath 'C:\Program  
Files\WindowsPowerShell\DscService\Configuration'
```

You should place the .mof files on pull server WinServer10 in a well-defined folder, typically in C:\Program Files\WindowsPowerShell\DSCService\Configuration. When the .mof file is generated, this folder location is passed as a parameter for the OutPath attribute.

After .mof file generation, the checksum file for the configuration needs to be generated. The checksum determines if a new configuration exists on the pull server or not. It also helps to

verify the integrity of configurations when they are transmitted between the pull server and the LCM. The checksum file must have the same name as the .mof file with .mof.checksum as an extension. DSC provides the `New-DSCCheckSum` cmdlet to generate the checksum file. The `ConfigurationPath` parameter specifies the folder location where configurations are stored. The cmdlet generates a checksum file for each configuration and saves the checksum in the folder location specified by the `OutPath` parameter.

IndexFile configuration

`IndexFile` is a simple configuration responsible for generating an `Index.htm` file on a server at the IIS default root directory (`C:\Inetpub\wwwroot\`). The purpose of this file is to show a “Website under maintenance” message to users. It uses a `File` resource and creates a file named `Index.htm` in the `C:\Inetpub\wwwroot` folder with HTML content displaying, in this example, “If you are seeing this page, it means the website is under maintenance and DSC Rocks!!!!!!” The configuration script that follows runs on the `DemoServerWin10` server. The name is `IndexFile.fcd03a8d-5a64-4982-92b3-5c89680add39`, and this is the same GUID

value shown earlier for the `IISInstall` configuration example.

```
$ConfigInfoIndex = @{
    AllNodes = @(
        @{
            NodeName = "IndexFile.fcd03a8d-5a64-
4982-92b3-5c89680add39"
        }
    )
}

Configuration IndexFile
{
    Node $AllNodes.NodeName
    {
        File IndexFile
        {
            DestinationPath =
"C:\inetpub\wwwroot\index.htm"
            Ensure = "Present"
            Type = "File"
            Force = $true
            Contents = "<HTML><HEAD><Title> Website
under construction.</Title></HEAD><BODY> `
                <h1>If you are seeing this page, it
means the website is under maintenance and DSC Rocks
!!!!</h1></BODY></HTML>"
        }
    }
}

IndexFile -OutputPath 'C:\Program
Files\WindowsPowerShell\DscService\Configuration' -
ConfigurationData $ConfigInfoIndex
New-DSCChecksum -ConfigurationPath 'C:\Program
Files\WindowsPowerShell\DscService\Configuration' -
OutPath 'C:\Program
Files\WindowsPowerShell\DscService\Configuration'
```

To function, the Configuration *IndexFile* must match the partial configuration defined in the Meta Configuration.

The .mof file is generated on the pull server DemoWinServer10 at the C:\Program Files\WindowsPowerShell\DSCService\Configuration folder location. The checksum file for this configuration is also generated the same way as for the previous configuration example.

Deploying the configurations

After addressing LCM and relevant authoring configurations for partial configurations, you apply them on the destination server, in this case on DemoServerWin. DSC provides the Update-DSCConfiguration cmdlet in its new release performs a pull and apply on the server. Running this cmdlet with the localhost as the ComputerName parameter simultaneously downloads from the pull server all relevant configurations (.mof content) defined by using the LCM PartialConfiguration. LCM then combines all the configurations into a single .mof file and applies it to the server. The following example shows the Update-DSCConfiguration cmdlet for applying the configuration:

```
PS C:\Users\me> Update-DSCConfiguration -  
ComputerName localhost
```

Id	Name	PSJobTypeName	State
HasMoreData		Location	Command
--	----	-----	-----
----	-----	-----	-----

```
47 Job47 Configuratio... Running True
localhost Update-DscConfiguration
```

Running the Get-DSCConfiguration cmdlet on this server provides all the resources (File and WindowsFeature) applied as part of DSC configuration, as shown here:

```
PS C:\Users\riteshmodi> Get-DSCConfiguration
```

```
ConfigurationName      :
DependsOn               :
ModuleName              :
ModuleVersion          :
ResourceId              :
SourceInfo              :
Credential              :
DisplayName             : Web Server (IIS)
Ensure                 : Present
IncludeAllSubFeature   : False
LogPath                :
Name                   : Web-Server
Source                 :
PSComputerName         :

ConfigurationName      :
DependsOn               :
ModuleName              :
ModuleVersion          :
ResourceId              :
SourceInfo              :
Attributes              : {archive}
Checksum               :
Contents               :
CreatedDate            : 7/8/2016
1:40:50 PM
Credential             :
DestinationPath        :
C:\inetpub\wwwroot\index.htm
Ensure                 : present
Force                  :
MatchSource            :
ModifiedDate           : 7/14/2016
```

```
7:09:02 AM
Recurse           :
Size              : 197
SourcePath       :
SubItems         :
Type              : file
PSComputerName   :
```

More info To learn more about working with Windows PowerShell DSC, go to <https://msdn.microsoft.com/powershell/dsc/overview>, and for more information in relation to PowerShell DSC Partial Configurations, go to <https://msdn.microsoft.com/powershell/dsc/partialconfigs>.

System Center 2016

Just like Windows Server, System Center gets an updated edition, too. In this section, we detail what's new for System Center 2016. The core focus of System Center 2016 is on hybrid management—how can we manage the cloud natively from System Center, but also how can we use the cloud to extend the functionality of system center or manage the environment from the cloud. Microsoft Operations Management Suite and Microsoft Intune are the management functions within the cloud that complement the System Center 2016 suite.

As you can imagine, a lot of what is new in System Center 2016 also focuses on ensuring that we can support the new capabilities in Windows Server 2016. Also, System Center 2016 is designed to truly facilitate the software-defined datacenter (SDDC) and gives you all the tools you require to accomplish this. In the following table, we give you a breakdown of some of the new features in System Center 2016 with respect to their general management areas:

Focus area	Features
Device management	Windows 10 deployment support MDM enrollment with Microsoft Azure Active Directory Access restriction based on device enrollment and policy
Provisioning	Support for Windows Server 2016 Technical Review Hyper-V features Rolling cluster upgrades Simplified networking Shielded virtual machine (VM) provisioning Guarded host management VMWare vCenter 5.5 support

Monitoring	<p>Nano Server</p> <p>Windows storage</p> <p>SMS-S support</p> <p>MP catalog improvements</p> <p>Performance improvements</p> <p>Enhanced data visualization</p> <p>Improved Linux support</p> <p>Improved network support</p>
Automation	<p>Migration to the cloud</p> <p>SCO integration packs and runbooks</p> <p>SMA support native</p> <p>Windows PowerShell</p> <p>Windows Management Framework 5.0</p> <p>Windows PowerShell ISE plug-in support for SMA runbooks</p>
Self-service	<p>Improved usability and performance</p> <p>HTML 5 self-service portal</p> <p>New Microsoft Exchange connector</p>
Data protection	<p>Azure Express Route supported</p> <p>Shielded VM support</p> <p>Storage spaces direct</p>

Traditionally, System Center was geared toward managing your on-premises infrastructure. This continued to evolve in the previous versions, and is yet even more of a focus in System Center 2016.

You can use System Center 2016 to manage your cloud environments, as well. For example, do you want to know the health of your Office 365 Subscription? In System Center 2016, you now can gather this information. Figure 5-9 shows a sample of the dashboard available in the Management Pack for Microsoft Office 365.

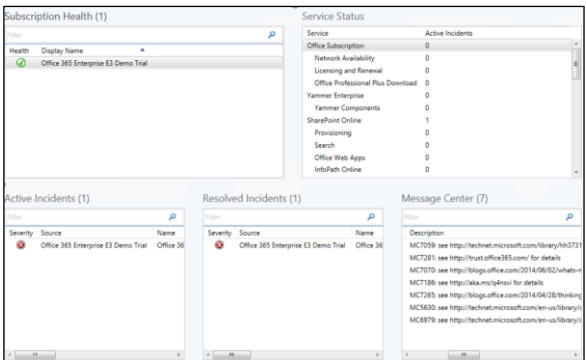

Figure 5-9: Office 365 dashboard view

The Subscription Health shown in Figure 5-9 validates whether your configuration is correct

and you have a successful connection to Office 365. You would configure a set of credentials as part of deploying this management pack, which would need the appropriate permissions to connect to the subscription. Figure 5-9 also illustrates the areas of the Office 365 subscription that have active incidents. The active incidents, much like other Operations Managers alerts, have a health state information and a knowledge center with possible resolution steps attached.

The previous example shows only Office 365, but it is only a small part of the capabilities inherent in System Center 2016 for managing a public cloud service. You also can extend management into public cloud environments from the perspectives of Infrastructure as a Services (IaaS), Platform as a Service (PaaS), and Software as a Service (SaaS).

Let's look at a quick scenario to show you how you can use the entire suite across all environments. Contoso Limited is a company that produces a simple widget. The widget is such a useful product that demand has grown exponentially since its release, and now the company requires a fully Agile IT solution that can meet the needs and demands of not only

the Contoso employees but also the Contoso customers.

Contoso customers want to be able to buy this widget at any time, from any place. And, of course, from any device! What does this mean in real terms? Simply put, Contoso needs a system that will be available 24x7. What does it mean in terms of infrastructure and management? First, we have two websites connecting to database servers hosted in the cloud. The first website is for customers, and the second is for the sales staff of Contoso to check inventory, look at orders, and so on. We also have mobile services so that phone apps can connect any time and place orders. The website for the sales staff uses Azure Active Directory (Azure AD) to authenticate users. This in turn means Contoso has extended its Active Directory to Azure to accommodate this. Contoso also uses Office 365 for its email and collaboration. Finally, the company integrated its telephony system with Office365 to allow for global telecommunications.

Contoso is stretched across the public and private cloud. It has a global customer base that is supported by a global employee base to serve those customer needs. Using System Center 2016, the company can provision infrastructure

when required, manage the application estate, integrate development and operations together so that true metrics showing how an application is being used can be reflected all the way in the development chain, provide detailed remediation and diagnostic tasks, and so on.

Although this might not seem like an example of real infrastructure today, the modern enterprise is evolving. Customers can and are often anywhere, and if you come from an environment where you host your systems based out of a region that is far away from a customer base, their end-user experience will not be good. Suppose that you host your central datacenters in the United States and you have offices and customers in India. The user experience will be bad because of the inherent distance-based latency alone. Let's further suppose that you decide to not use the cloud to host your applications and instead decide to open a local datacenter in India. What happens then is you duplicate your management structure and the system becomes more complex to manage. There are multiple scenarios we could discuss which highlight the evolving nature of IT and how to manage it.

When Microsoft was designing System Center 2016, a key focus was to address the Contoso

scenario, not just from managing on-premises out to the cloud, but in either direction. Another key area was how to keep up with cloud cadence, the investment to keep System Center 2016 up to date and move at the speed of the cloud is considerable, but making investments to have a hybrid relationship between a management solution based in the cloud and on-premises investments make sense. In the next section, we will look at Operations Management Suite which can help us take this journey

Operations Management Suite

Operations Management Suite (OMS) is a cloud-based management solution that can complement on-premises investments in System Center 2016 or stand independently. Figure 5-10 shows how you can manage multivendor environments and get the best experience possible by combining System Center 2016 and OMS to manage your hybrid IT world.

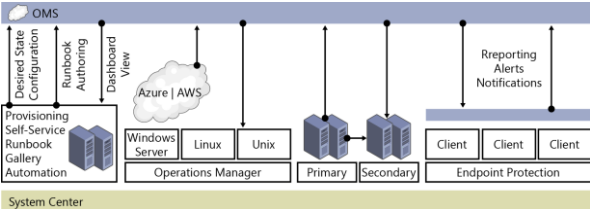

Figure 5-10: Using System Center 2016 and OMS to manage a multivendor environment

Before diving into how we can take advantage of the capabilities of OMS and System Center 2016, let's describe what's available in OMS. We can divide OMS into the following four primary areas:

Focus area	Description
Log analytics	Search for patterns; identify problems across a multitude of different log sources and provide real-time insights into what is happening in your environment; Integrate into Microsoft Power BI dashboards for powerful visualizations.
IT automation	Automate simple and complex tasks in your IT environment; directly integrate with applications and provide source control for your automation environment; connect and manage resources across datacenters.

Backup and recovery	Back up your workloads directly to the cloud and use the cloud as a recovery point. Alternatively, replicate your workloads from VMware or Hyper-V and use the cloud as a recovery site.
Security and compliance	Continually assess and understand what is happening in your environment, from who is signing in to a new risk that is highlighted in your environment.

The key takeaway here is the ability to be hybrid. This is particularly relevant if you have made a large investment on-premises and want to use OMS and its features along with System Center 2016. Even if you haven't made any investment into System Center on-premises but like what OMS can offer, no problem: You can take advantage of OMS to manage your existing cloud or on-premises estates.

To begin, whether you have OMS deployed or not, you must create an OMS workspace. To do so, sign in to <https://portal.azure.com>, and then click New. Next, type **Log Analytics (OMS)**, click

Log Analytics (OMS) (see Figure 5-11), and then click Create on the next page.

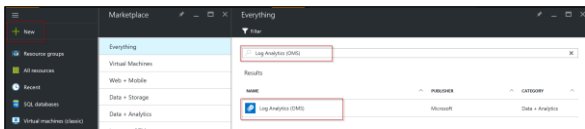

Figure 5-11: Creating your OMS workspace, part 1

This will open the OMS Workspace dialog box; you will need to populate the settings to match those shown in Figure 5-12 and then click Create Workspace. You have a choice of tier; for most users, the Free tier is a great way to explore the power and benefits of OMS.

OMS Workspace
Create new or link existing one created i...

* OMS Workspace ⓘ
demoworkspace2016 x ✓
[Or link existing](#)

* Subscription
WW Azure Subscription v

* Resource group ⓘ
 Create new Use existing
pfedemo v

* Location
Australia Southeast v

* Pricing tier
Free >

Figure 5-12: Creating your OMS workspace, part 2

Note If you chose Operational Insights you will be redirected to the Azure Service Management (ASM) portal and then back to the Azure Resource Manager (ARM) portal. Selecting Log Analytics performs the same function.

After the workspace is created, go to Log Analytics (OMS). You should see that your workspace status is listed as Active.

There are many settings in this page (too many for this book), but for a quick example, if you observe in the Data Sources section, there are two options: one for Virtual Machines and one for Storage Accounts. If you click the Virtual Machines tile it will open a new page displaying VMs that exist in the resource group into which you have published the Log Analytics (OMS) workspace, as shown in Figure 5-13.

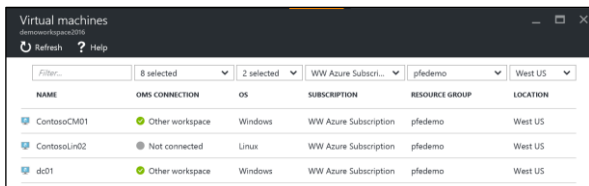

NAME	OMS CONNECTION	OS	SUBSCRIPTION	RESOURCE GROUP	LOCATION
ContosoCM01	Other workspace	Windows	WW Azure Subscription	pfedemo	West US
ContosoLin02	Not connected	Linux	WW Azure Subscription	pfedemo	West US
dc01	Other workspace	Windows	WW Azure Subscription	pfedemo	West US

Figure 5-13: VMs in the resource group

As you can see, there is three VMs; two are connected to another OMS workspace and one is currently not connected to any. If you click this VM, it will give you the option of using the Azure VM Extensions capabilities to install an OMS agent and automatically register to your workspace, as shown in Figure 5-14

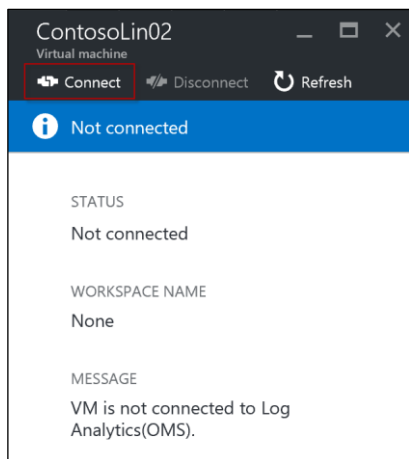

Figure 5-14: Connecting a VM automatically to OMS

Return to the main OMS page and then, in the Data Resources section, click Storage Accounts. Note that it is blank, as shown in Figure 5-14; this is by default. You need to add a storage account to which you can store log data from a variety of sources (again, refer to Figure 5-14). OMS will use this account to ingest that information into its engine.

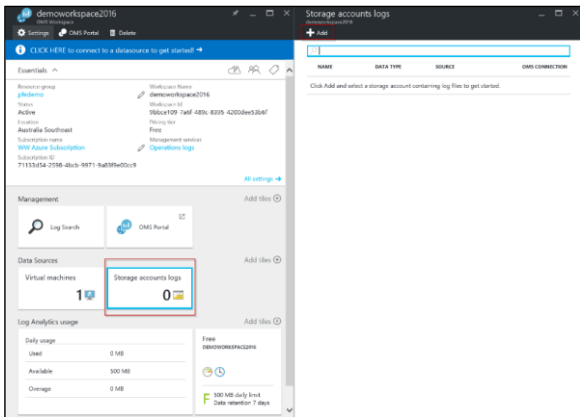

Figure 5-15: Connecting a storage account for OMS

After you click the Add button, the Add Storage Account Log dialog box opens. Here, you need to provide some information, the first of which is selecting the storage account that you want to use. Then, select the Data Type, of which there are several to choose. For example, you can potentially select the following options:

- IIS Logs
- Events
- SysLogs (Linux)
- ETW Logs
- Service Fabric Events

Figure 5-16 shows a sample of the fully populated dialog box.

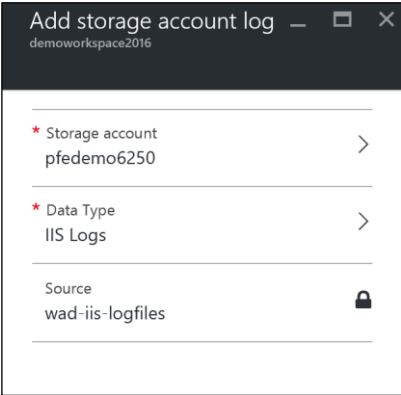

Figure 5-16: The Add Storage Account Log dialog box with all the needed information filled in

There are multiple options that you can play with and add more resources as you expand or more storage accounts as required, but for now, let's not click into the main OMS portal.

Return to the Log Analytics page and click the workspace you want to work with. On the page that opens, in the Management section, click OMS Portal to bring you to the OMS Portal, as depicted in Figure 5-17.

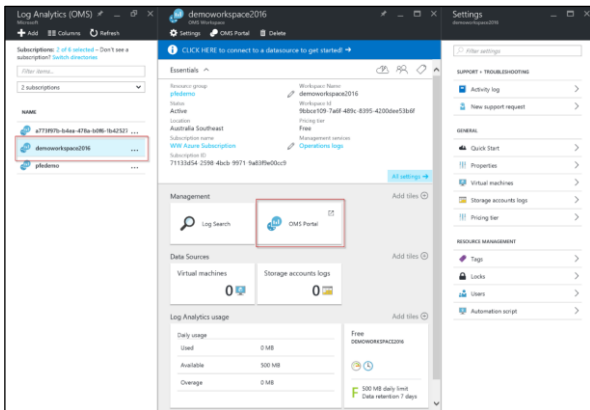

Figure 5-17: Click a workspace to manage it

This brings you to some basic settings, one of which you might want to consider implementing. In Azure, a lot of services have the ability to write log files directly to a Storage account. You can add this account to the workspace so that you can later perform analysis on it.

When you sign in to the workspace, the first thing you need to do is click the Get Started tile, as shown in Figure 5-13.

Note if you have preconfigured data sources from the Azure Portal they will show up here.

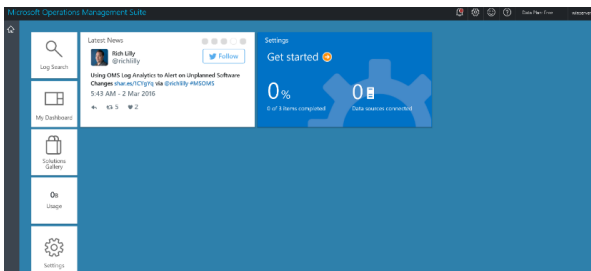

Figure 5-18: The main workspace

There are three main tasks to accomplish when you get started with OMS. When you click Get Started, a wizard-like experience guides you through the process of selecting solutions. Solutions are like management packs in OMS. They contain all of the intelligence and rules against which machines in the environment you present will be assessed. Solutions are updated on a cloud cadence, and new solutions are continually being developed and added to the overall portfolio based on customer demands and requirements.

Figure 5-19 depicts the first step in configuring OMS. To get up and running requires that you select some solutions. In the pane on the left, click Solutions. These solutions won't really do anything until they have machines to work against, so you can technically select all of them

or only the ones with which you are interested in working.

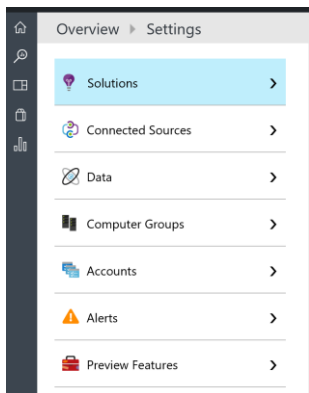

Figure 5-19: Step one: selecting solutions

Next, click **Connected Sources**. Figure 5-20 shows the range of options from which you can select depending on your environment.

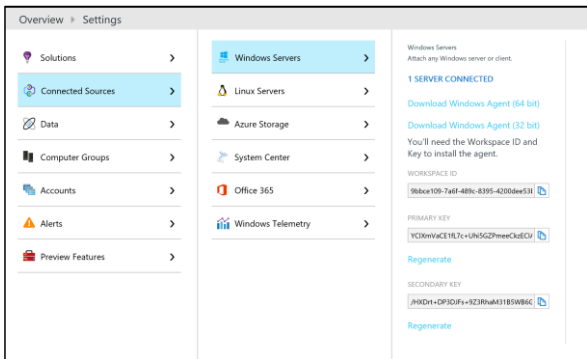

Figure 5-20: Step two: connecting sources

Here, you have three basic questions to answer:

- Do you want to deploy an agent directly to a machine and register directly with OMS?
- Do you want to connect an operations manager deployment to OMS?
- Do you want to add a Storage account that contains log data?

Your answers will determine which steps you take to complete the installation. If you want the destination machine to report directly to OMS, download the agent and install it on the machine. During the installation, you will be prompted to select the type of deployment that you want to register the agent against. The

agent itself is the Microsoft Management Agent, which can be registered directly with OMS or an OMS server, as shown in Figure 5-21.

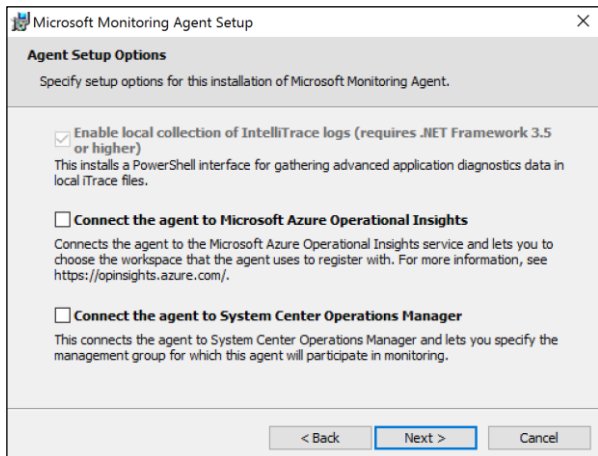

Figure 5-21: Installing the Microsoft Monitoring Agent

When you select the Connect The Agent To Microsoft Azure Operational Insights check box, you are prompted for the workspace ID and key. You can obtain these from the Operational Workspace, as previously shown in Figure 5-20, and type or copy them into the boxes, as shown in Figure 5-22.

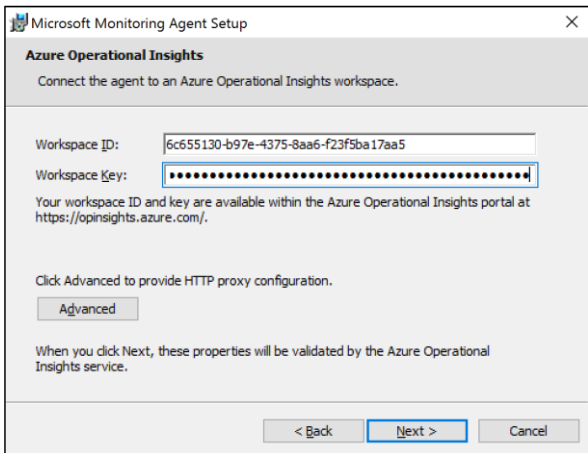

Figure 5-22: Configuring the Workspace ID and Key

The agent will complete its installation and then register with the OMS workspace. When the agent has registered with OMS, you will see a green check mark beside Step 2, and you will see one server connected in the OMS workspace.

Finally, in Step 3, you can configure to add some additional data that you might be interested in from the sources you are collecting. Figure 5-22 shows the different log types you can select. For example, in the search box, you can type **free** for Windows Event Logs and then type **System**, and you will see it will try to resolve the available logs. Ensure that you click Save.

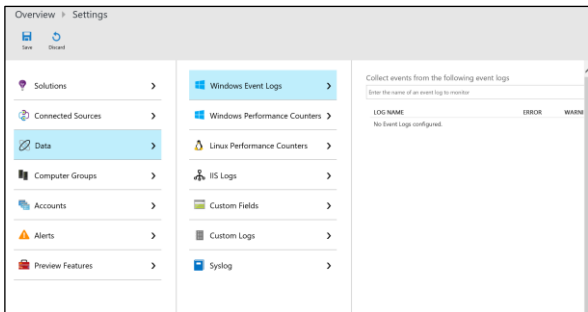

Figure 5-23: Adding logs

From here the rules are downloaded to the agent, as normal, and processed. Data will be uploaded to the portal and assessed. The main solution gallery will be updated with the latest information pulled from the system. You can add additional solutions from the solutions gallery when you need them.

Figure 5-24 presents an updated dashboard after information has been uploaded.



Figure 5-24: Updated dashboard

You can click each site to view more information. From here you can also configure additional items such as Automation, Backup, and Azure Site Recovery. You can use all three areas in hybrid scenarios to manage cloud resources and on-premises resources from the cloud.

From here, you can explore Log Search and all additional solutions, as shown in Figure 5-25.

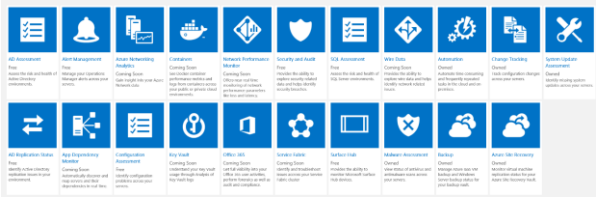

Figure 5-25: Solution gallery in OMS

More info To learn more about OMS, go to <https://www.microsoft.com/cloud-platform/operations-management-suite-resources>.

Server management tools

As infrastructure and deployments become more hybrid in nature, where we have workloads spread across clouds, the management effort to control all these different areas increases exponentially. This is obviously a bad thing and we want to be able to provide a more controlled way to manage resources which might exist on-premises but also in Azure.

Server management tools (SMT) introduces a web-based GUI hosted in Azure and command-line tools that can do this for your Windows

Server 2016 estate. For instance, your administrators can manage Nano Server or server core easily from this GUI without affecting the footprint of those deployments.

The tool currently has the following capabilities

- View and change system configuration
- View performance across various resources and manage processes and services
- Manage devices attached to the server
- View event logs
- View the list of installed roles and features
- Use a Windows PowerShell console to manage and automate

Figure 5-26 presents an overview of what a deployment with the server management tools would look like.

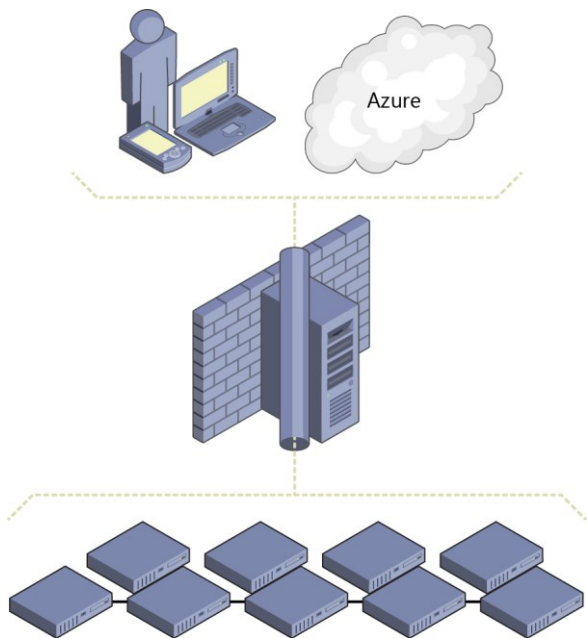

Figure 5-26: Sample deployment for server management tools

You will also observe from the diagram that a gateway server (in the middle of the diagram) is required to allow on-premises infrastructure to communicate with the service in Azure.

SMT support for Windows 2012 and later

If this is a Windows 2016 Server, no prerequisite work is required, but if you are using a previous edition of Windows (i.e., 2012 or 2012 R2) you must install WMF 5.0 so that you can manage Windows Server 2016 hosts, including Nano Server.

With the exception of Windows Update and Device Manager, all SMT tools will work with Windows 2012 and 2012 R2. There is one thing to consider when approaching SMT and using it to manage your previous versions of Windows: the dependencies of installed applications on the server. For example, will your application break if you install a newer version of WMF?

Note To verify if you can install WMF 5.0 before proceeding to connect the server to SMT go to <https://msdn.microsoft.com/en-us/powershell/wmf/5.0/productincompat>.

You might also need to perform additional tests to ensure that your applications perform correctly with WMF 5.0.

Persistent credentials

In Windows Server 2016 Server Management Tools, you can store credentials encrypted by using AES256 encryption and stored in Azure. The gateway is responsible for encrypting these credentials with a certificate that only exists on the gateway before uploading the credentials to Azure in a secured state. These credentials can then be decrypted only by the gateway using the certificate that encrypted the credentials in the first place. The certificate, as stated, never leaves the gateway and only ever exists on the gateway.

Firewall rules

Centrally managing a Windows firewall provides numerous benefits to servers by ensuring that a standardized policy is enforced. Unfortunately, dealing with a Windows firewall outside of traditional enterprise monitoring tools typically has been a difficult task; you can't easily work at scale and it can be difficult to gather a complete understanding what rules are turned on and what their status is. In SMT, Microsoft provides GUI support for looking at the firewall rules on a specific machine, making it easier to understand what is happening, as demonstrated in Figure 5-27.

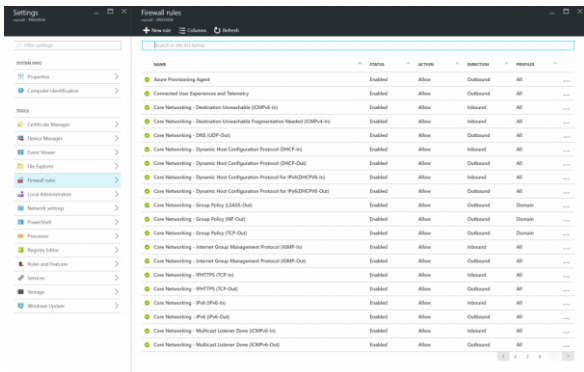

Figure 5-27: Firewall Rules in SMT

Windows PowerShell script editor enhancements

The Windows PowerShell script editor in SMT has been upgraded to support file-browsing capabilities on a machine. Now, you can open, edit, and save scripts on specified machines.

The script editor also has the ability to connect directly to an Azure Storage Blob (see Figure 5-28) and save your scripts to it. The scripts then become accessible to all servers in your subscription and beyond!

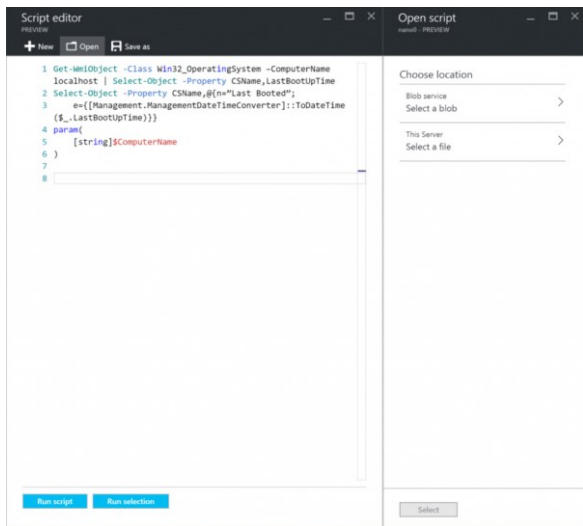

Figure 5-28: The Windows PowerShell script editor in SMT connecting to Blob Storage

File Explorer

Along with the Windows PowerShell script editor's basic capabilities to interact and work with scripts on specified machines, you also can perform basic file management activities like browse, rename, and delete. Figure 5-29 shows you a sample of what File Explorer in SMT looks like.

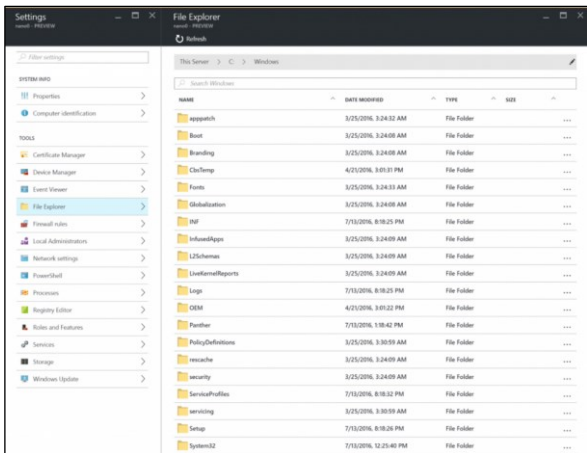

Figure 5-29: File Explorer showing the contents of a machine in SMT

Local storage

SMT now has the ability to provide more detailed info on storage for a specific machine. You can display information about drives, volumes and file shares. Currently, that information is available in a read-only format, but this technology will evolve over time. Figure 5-30 demonstrates this capability.

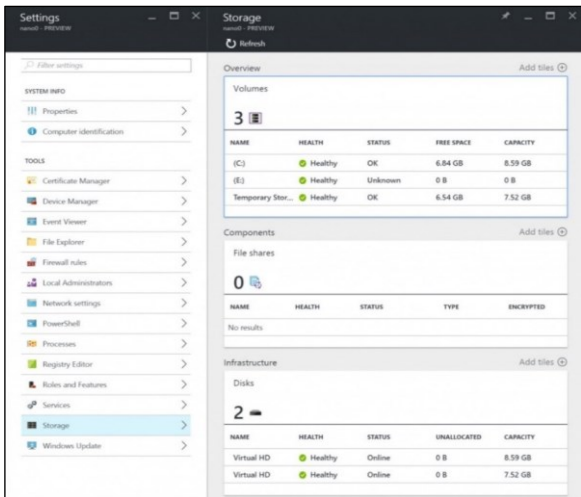

Figure 5-30: Storage information in SMT

Certificate Manager

Certificates for any IT organization presents challenges in terms of its management; for example, how do you verify certificates across multiple machines if you don't run a Certificate Authority. SMT introduces a certificate manager so you can now remotely manage certificates on specified machines. Figure 5-31 shows how you now can view all or a scoped set of certificates, look at the event log, and manage certificate lifecycles with import, export, and delete functions.

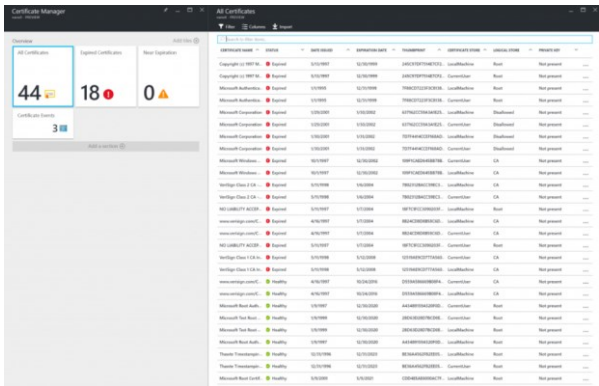

Figure 5-31: Certificate Manager in SMT

Deployment

Deployment of SMT is relatively straightforward; however, it does involve the use of Azure and will require an Azure subscription. There are various ways of obtaining an Azure subscription but the simplest is to go to <https://azure.microsoft.com/free/>. Here, you can create a subscription if your organization does not already have one.

The gateway server you will create also needs Internet access, so it will need to be on a routable subnet within your organization.

There are two methods to deploy SMT: via the Azure Portal or Windows PowerShell. For the

GUI deployment you can go to <https://blogs.technet.microsoft.com/servermanagement/2016/08/17/deploy-setup-server-management-tools/>. To use Windows PowerShell, go to <http://social.technet.microsoft.com/wiki/contents/articles/35196.microsoft-azure-managing-nano-server-with-server-management-tools.aspx>.

More info For all the latest information on SMT, read the product group's blog at <https://blogs.technet.microsoft.com/servermanagement/>.

About the author



John McCabe works for Microsoft as a senior premier field engineer. In this role, he has worked with the largest customers around the world, supporting and

implementing cutting-edge solutions on Microsoft Technologies. In this role, he is responsible for developing core services for the Enterprise Services Teams. John has been a contributing author to several books, including *Mastering Windows Server 2012 R2* from Sybex, *Mastering Lync 2013* from Sybex, and *Introducing Microsoft System Center 2012* from Microsoft Press. John has spoken at many conferences around Europe, including TechEd and TechReady. Prior to joining Microsoft, John was an MVP in Unified Communications with 15 years of consulting experience across many different technologies such as networking, security, and architecture.



From technical overviews to drilldowns on special topics, get free ebooks from Microsoft Press at:

www.microsoftvirtualacademy.com/ebooks

Download your free ebooks in three formats:

- PDF
- EPUB
- Mobi for Kindle

Look for other great resources at Microsoft Virtual Academy, where you can learn new skills and help advance your career with free Microsoft training delivered by experts.

Microsoft Press